

WIPO STANDARD ST.35

RECOMMENDED STANDARD FORMAT FOR DATA EXCHANGE OF MIXED-MODE PUBLISHED PATENT DOCUMENT INFORMATION ON REEL-TO-REEL AND IBM 3480/90 CARTRIDGE TAPES

Version 2, August 1999

INTRODUCTION

1. This Standard defines the formats to be used for the data exchange and processing of published patent information in mixed-mode (**MM**) form on 1/2 inch reel-to-reel and IBM 3480/90 cartridge magnetic tape (**Mixed-Mode Magnetic Tape - MMMT**). The Standard is based upon international standards and recommendations (ISO, WIPO, ITU-T (CCITT)); where necessary explicit references to these are made. The Standard provides for a device and layout independent presentation of patent documents with particular reference to exchange on magnetic tape.

2. The purpose of the Standard is, therefore, to provide a logical, independent, structure for patent document processing and for the data exchange of all data pertaining to one or more patents, be this text and/or image data. This means that this Standard may be used in place of WIPO standards: ST.30, "*Recommendation concerning a standard magnetic tape format for the exchange in machine-readable form of bibliographic data, abstracts and full texts of patent documents*" and ST.33, "*Recommended standard format for data exchange of facsimile information of patent documents*".

Generally, the data exchanged may be used for building and updating bibliographic patent databases but it could also be used for full text and image patent databases - on any media: tape, hard disk, CD-ROM, etc. In particular the Standard allows for the processing of the following data:

- a) Full text, or parts, of patent documents, including bibliographic data, recorded as character coded-data. It is strongly recommended that this data is marked up with SGML tags according to WIPO ST.32 (see below).
- b) Whole pages of documents represented as one image irrespective of their content (bibliographic data, text, or images).
- c) Data, within full-text documents, which cannot be recorded as character coded data, such as drawings, chemical formulae, complex tables, etc., may be treated as so-called embedded images (EMI's) and are defined as frames.

Notes:

- i) Information about the text and image data must be given according to the identification and prefix information in "Appendix 2";

ii) For image data (2b,c above), the compression format recommended is ITU-T (CCITT) T.6: Group 4 (commonly known as 'Fax Group 4'), other image formats are possible;

iii) An alternative method of image data storage is given in "Appendix 4": Tagged Image File Format (TIFF). Again, the compression format, within the TIFF record, recommended is ITU-T (CCITT) T.6: Group 4.

REFERENCES

3. The following standards are of fundamental importance to this recommendation:

a) WIPO Standard ST.32 - Recommendation for the markup of patent documents using SGML (Standard Generalized Markup Language).

b) WIPO Standard ST.33 - Recommended standard format for data exchange of facsimile information of patent documents.

(*Note:* the prefix information in Appendix 2 is similar but *not* the same as ST.33, that used in ST.33 formed the basis of indexing for this Standard.)

c) ISO 1001, Information processing - Magnetic tape labelling and file structure for information exchange.

d) ISO 8879-1986, Information processing - Text and office systems - Standard Generalised Markup Language (SGML).

e) ITU-T (CCITT), Blue Book, Volume VII - Fascicle VII.3 - Terminal Equipment and Protocols for Telematic Services - Recommendations T.0-T.63 - Recommendation T.6 - Facsimile Coding Schemes and Coding Control Functions for Group 4 Facsimile Apparatus (1984, amended 1988).

f) Tagged Image File Format (TIFF). As administered by Microsoft Corp. on behalf of Aldus. (Detailed information about the structure of TIFF can be found in the Microsoft Windows Software Development Kit version 2.0 manual: 'Windows Extensions' chapters 1 through 7. It is available through the courtesy of Hewlett-Packard Company, Greely Division).

APPENDICES

4. The appendices to this Recommendation contain the following:

- Appendix 1 Character Set for Label and Record Prefix Coding (IBM EBCDIC)
- Appendix 2 Prefix Item Definition
- Appendix 3 Facsimile Coding Convention
- Appendix 4 Tagged Image File Format (TIFF)
- Appendix 5 Examples of Coding Mixed-Mode Patent Documents

DEFINITIONS

5. For the purposes of this recommendation, the following specific definitions apply:

- a) **RECORD LABEL:** A short file on the magnetic tape containing the name and characteristics of the entire tape. A labelled tape starts with a volume label and each data file on the tape has a preceding header label and a following trailer label. In this respect this Standard follows ISO Standard 1001.
- b) **PATENT DOCUMENT:** The expression “patent document” comprises patents for invention, plant patents, inventors’ certificates, design patents, utility certificates, utility models, documents of addition thereto and published applications therefor. (A patent document may contain patent sub-documents - see below.)
- c) **LOGICAL RECORD:** A collection of all fields and data referring to one and the same patent document and being treated as one entity. A logical record may contain different document components.
- d) **DOCUMENT COMPONENT:** A collection of fields and data within a logical record (patent document) which may be treated as one entity, e.g., the full text of a patent document, one image.
- e) **PATENT SUB-DOCUMENT:** Within the variable part of a text component a patent document may contain sub-documents such as: bibliographic data, abstract, description, claims, drawings, search report.
- f) **IMAGE COMPONENT:** An image component will consist of one image: an embedded image, a drawing, a full page facsimile image (which may contain several images).
- g) **BLOCK:** A collection of records that can fit into 20,000 bytes.

h) **PHYSICAL RECORD:** A collection of all fields and data within a document component which may be treated as one entity. When the size of a document component exceeds the block size of 20,000 bytes the data must be spanned over more than one physical record.

i) **SPANNING:** a technique used for splitting a logical record into more than one physical record because the size of a logical record is bigger than the maximum size of a physical record.

PART 1: MIXED-MODE (LOGICAL RECORD AND COMPONENT) SPECIFICATIONS

6. This part of the Standard describes the recommended general logical layout and formatting of published patent documents exchanged on 1/2 inch reel-to-reel and IBM 3480/90 cartridge magnetic tape media described in Part 2, paragraph 14.

7. A logical record may *not* contain more than one patent document.

8. A dataset (file) with electronic patent documents may contain a sequence of logical records organised in, for example, ascending order of document identification.

9. Each logical record may contain information both in character-coded (text) and/or image form with respect to a patent document.

10. The following figure shows the general structure:

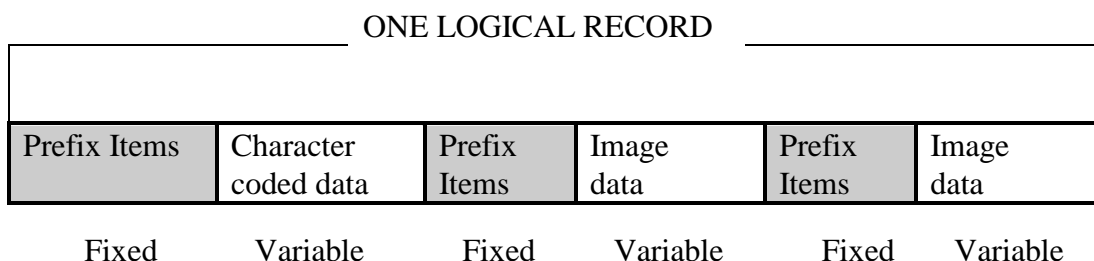

11. The Prefix Items may contain country code, document number, kind, etc., and any other general information which is useful for the processing of the variable part of the document. (See "Appendix 2".)

12. The variable part may contain two major components:

a) for the character-coded part the component may consist of all text data associated with a patent document; that is sub-documents such as: bibliographic data, abstract, description, claims, drawings, search report, etc. It is *strongly* recommended that this data is coded according to WIPO Standard ST.32, which defines SGML tags allowing the data to be

structured in such a way that further processing is facilitated. In particular the tags include references to image data within the text - so called embedded images - coded according to the <EMI> tag. This provides a link to the image itself. (The recommended character sets and character entity references for this data are also specified in WIPO ST.32.)

[For the character-coded part it is also possible to treat one page, of a patent document, as one component followed by all related image components (if any). In this case certain prefix item definitions, e.g., 18 (see Appendix 2 below), gain more importance.]

b) for images, a component is created for each coded image (either full pages or embedded) coded by EMI or RTI (see below). Each image, either full page or an embedded image, is thus considered as a component. The images are recorded in the sequence of their occurrence in the document's logical record, as referred to in its corresponding position in the character coded part. These must correspond exactly.

13. Images can be stored in the variable part in various ways:

- a) Group 4 bitmap only;
- b) TIFF coded Group 4 bitmap.

The Standard allows for further extensions (CGM, JPEG, etc.) - in the prefix it is specified how the image is stored.

The sequence of the images may be identified by an eight byte sequence number. Usually this is composed of four characters for the page number followed by four characters for the frame number. Alternatively, it may be a consecutive number starting from one for each document (for example in cases where electronic publishing methods are used without reference to a paper document). The logical layout and relationship of these variable components can be illustrated as follows:

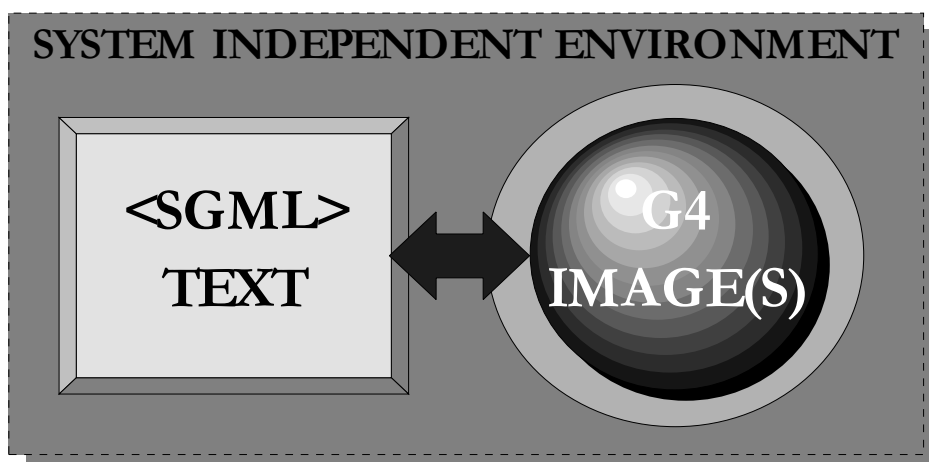

A typical patent document could be structured as follows (tagging according to WIPO ST.32):

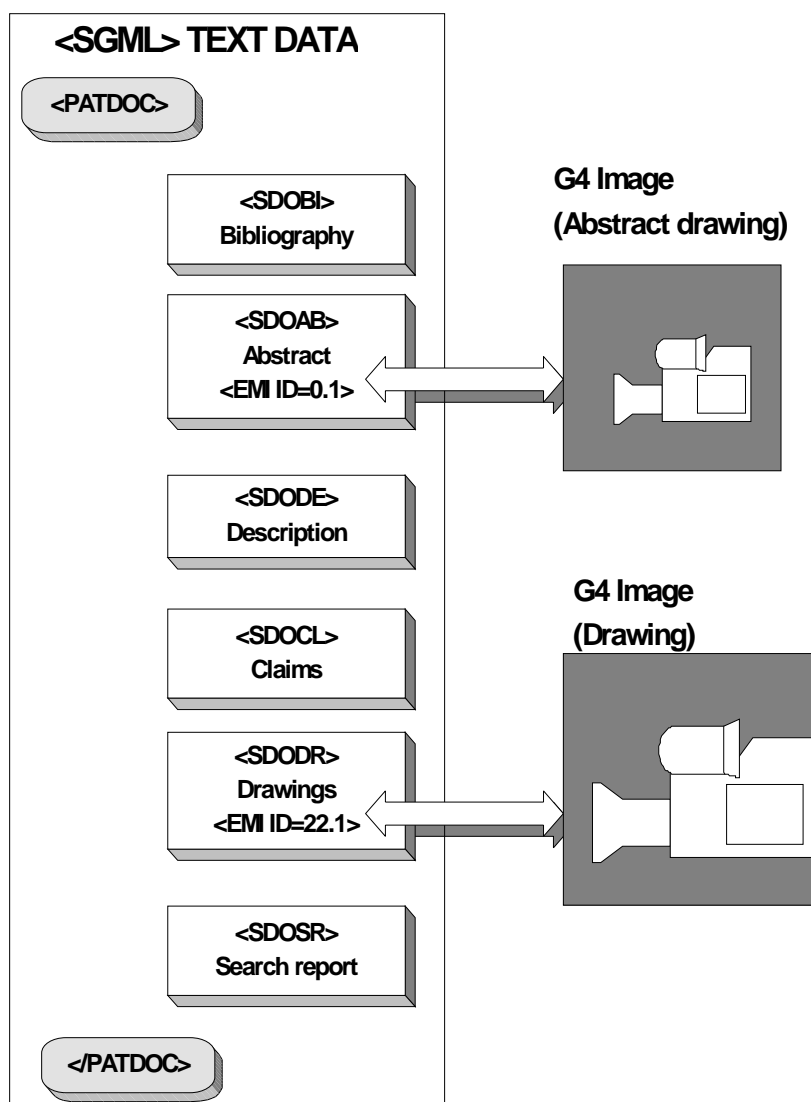

In the example above, therefore, we have one patent document (logical record) containing three document components: the text data and two images. One component, the text data, contains six patent sub-documents. The link between the components is maintained by the <EMI> tags in the text data and the corresponding prefix information in the image data. The file name for the logical record, usually the patent application or publication number, can bind all components together. Further examples can be seen in "Appendix 5".

The following section of the Standard shows how this data can be written onto magnetic tape (reel or cartridge) for data exchange. The use of other media, rather than magnetic tape, remains open for further study.

PART 2: PHYSICAL COMPONENT SPECIFICATIONS FOR MAGNETIC TAPES

Magnetic Tape Standard Specifications

14. The standard specifications of the magnetic tape will be as follows:

- a) ½ inch, 9 track magnetic tape reel; or 18/36 track IBM 3480/90 tape cartridge;
- b) recording density of 6250 bpi for tape reel; 48 KB/inch for cartridge;
- c) standard labels for Volume, Header 1 and Header 2 as provided for in ISO Standard 1001, which, in respect to labelling, is compatible with IBM labels; user labels may also be added;
- d) label and record prefix encoding shall be in the Roman alphabet and in Arabic numerals, fully compatible with IBM EBCDIC and with the code set of characters shown in “Appendix 1”;
- e) one file can be spanned over multiple tape volumes in accordance with ISO 1001 standard.

File Layout

15. ISO standard 1001, which defines magnetic tape labelling, label layout and usage, should be followed.

16. Each data set (file) may contain a collection of logical records each representing a patent document.

17. The following figure shows the general structure of a file:

1001 header label	logical record 1	logical record 2	logical record 3	1001 trailer label
----------------------	---------------------	---------------------	---------------------	-----------------------

18. The maximum number of physical records in a logical record is $(2^{32} - 1)$. Therefore, the theoretical logical record size should be less than $(2^{32} - 1) \times 19,996$ positions (the maximum block size 20,000 minus the block length indicator of 4 bytes).

19. The total maximum physical record size is 19,996 including record length indicator of 4 bytes.

Physical Record Specifications

20. A physical record has the following specification:

- a) the recording mode is variable blocked; that is: a block may contain several physical records;
- b) the maximum block size is 20,000, including the block length indicator of 4 bytes;
- c) the total maximum physical record size is 19,996 including record length indicator of 4 bytes;
- d) the physical record layout may be schematically shown as:

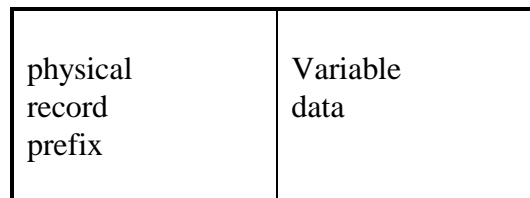

21. Each physical record starts with a prefix of 256 bytes. This includes the record descriptor word (binary record length indicator of four bytes), however, depending on the system environment, this field may not be directly accessible by some application programs, e.g., IBM OS/VS COBOL. The prefix is defined in "Appendix 2".

22. For each component there is created at least one physical record. When the size of a component exceeds the maximum physical length then a spanning technique, described below, is used to create more physical records.

23. Physical records are created on magnetic tape using the variable record organisation.

Spanning Technique

24. A spanning technique is necessary for components due to the inability of magnetic tape devices to handle, under normal circumstances, physical records in excess of 20,000 characters. The record prefix contains two items concerning the spanning technique, viz. item 9 and 19 (component record sequence number and highest document component record sequence number, both two byte fields, see "Appendix 2", to be used by application programs).

25. In order to illustrate an example layout of the data on the tape, and associated prefix items, the following illustrations may be helpful:

(Note: Normally the first component will always contain character coded data; followed, possibly, by n number of image components).

File layout

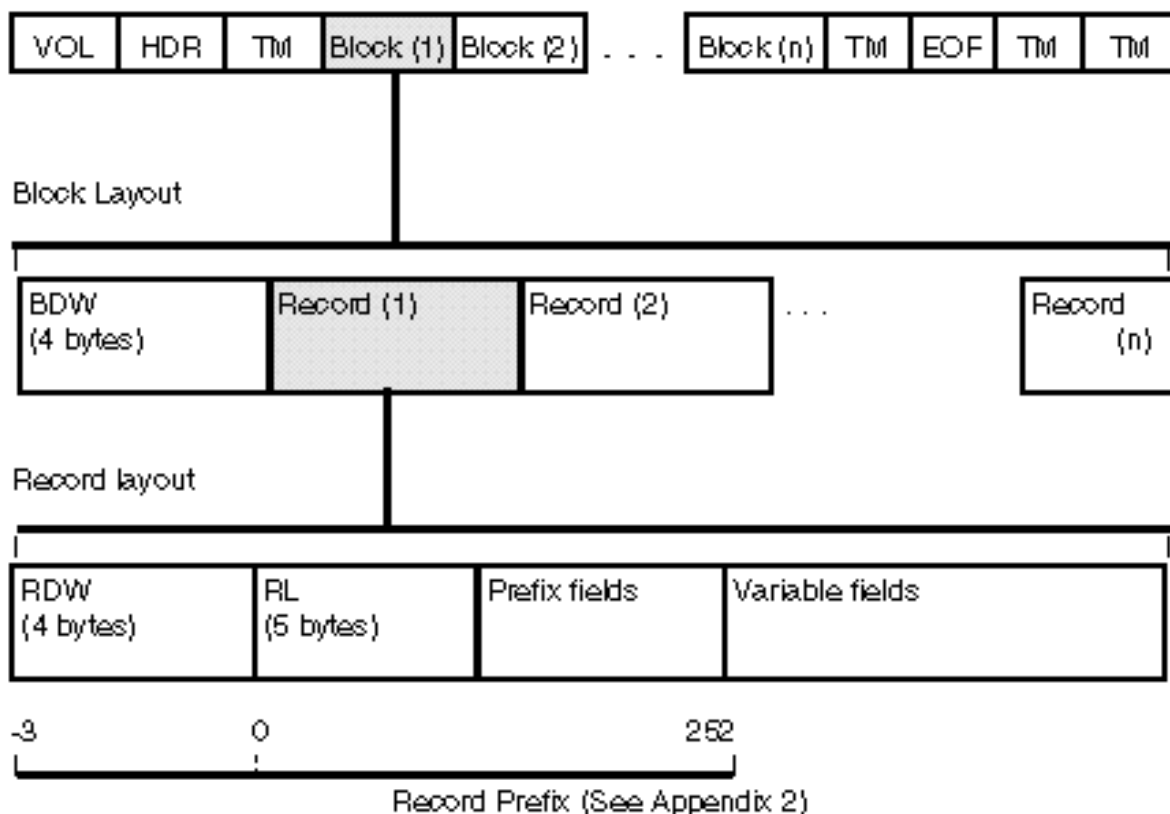

- VOL = Tape volume id
HDR = Header records
EOF = End of file records
TM = Tape mark
- BDW = Block descriptor word in 4 bytes:
- Bytes 1-2 contains the actual block length in hexadecimal, e.g., 19774 is stored as x'4D3E'.
 - Bytes 3-4 contains the hexadecimal value x'0000'.
- RDW = Record descriptor word in 4 bytes:
- Bytes 1-2 contains the actual record length in hexadecimal, e.g., 1526 is stored as x'05F6'.
 - Bytes 3-4 contains the hexadecimal value x'0000'.
- RL = Record length in 5 bytes

The maximum record length is 19,992 bytes (excluding the record length word (RDW) of 4 bytes) with a fixed part of 252 bytes. From position 253 onwards, the record contains variable length data.

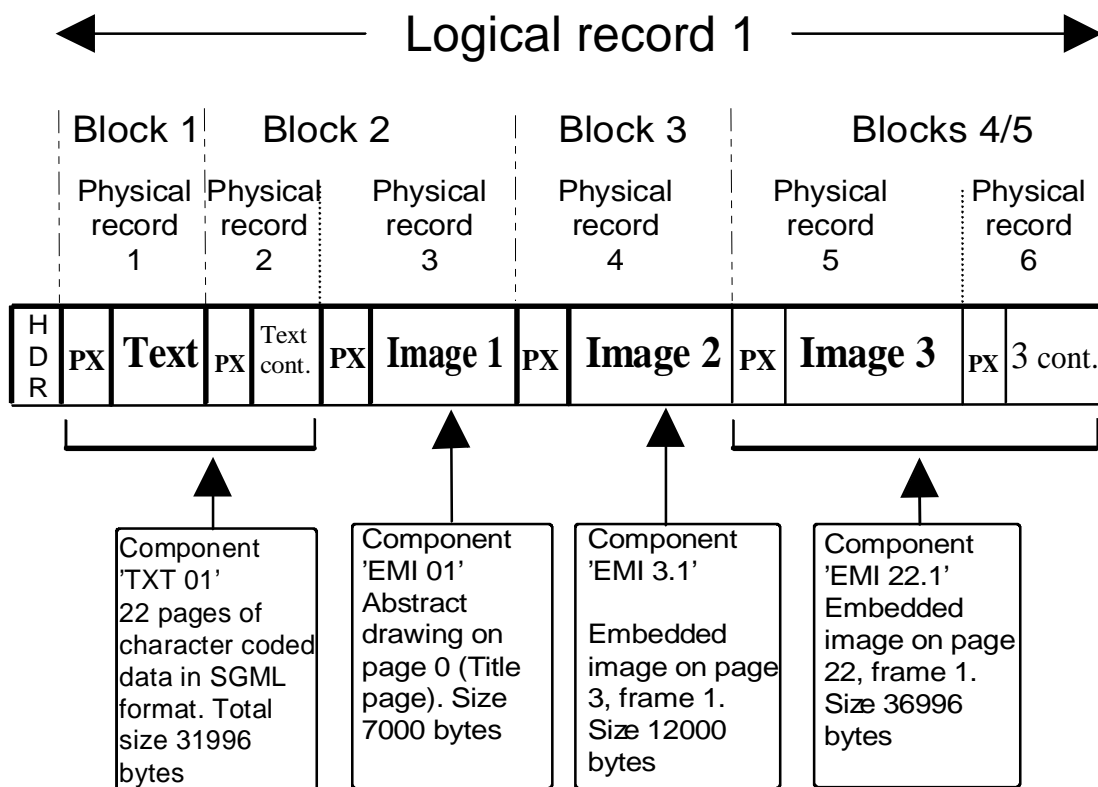

Block	Physical tape record	(7) Doc. comp type	(8) Doc. comp. id. no.	(9) Doc. record seq. no.	(17) Highest frame no. in page	(18) Highest doc. record seq. no.	(19) Highest doc. component record seq. no.	(1) Record length	Block length
1	1	TXT	00000001	1	N/A	6	2	19996	20000
2	2	TXT	00000001	2	1	6	2	12000	
2	3	EMI	00000001	1	1	6	1	7000	19004
3	4	EMI	00030001	1	1	6	1	12000	12004
4	5	EMI	00220001	1	1	6	2	19996	20000
5	6	EMI	00220001	2	1	6	2	17000	17004

Notes:

- HDR = Header label
- PX = Prefix items (see tables below in “Appendix 2”)
- The numbers in parenthesis, e.g., (7), refer to the prefix items detailed in the tables in “Appendix 2”

EXAMPLE

26. Examples of coding mixed-mode patent documents are given in “Appendix 5”.

ASCII Character Set Usage

27. The usage of the ASCII character set, as an alternative to the EBCDIC character set, for prefix items is allowed and does not affect field sizes. In other words the only requirement is an indicator saying that the data is in ASCII and not in EBCDIC.

28. It is recommended to use a one byte field and store an “A” in ASCII for ASCII coded data or an “E” in EBCDIC for EBCDIC coded data. In the prefix information this can be position 19 (i.e., the first byte of item 6: “Others”)

29. For the fields coded as binary data it is recommended to have this data available in character format, because of the differences in interpretation of binary data in various operating systems (e.g., UNIX). Here it is also proposed to use “free” fields from items “Others”. The fields coded in binary are:

a) Item 9: Document component sequence number, 2 bytes. The maximum value in practice shall never exceed 10,000 (-1), so a field length of 4 characters (in ASCII or EBCDIC) will be sufficient. The space can be found in item 23: position 107-110.

b) Item 18: Highest document record sequence number, 4 bytes. The maximum value shall never exceed 1,000,000 (-1), so a field of 6 characters (in ASCII or EBCDIC) will be sufficient. The space can be found in item 23 (others exchange use): position 111-116.

c) Item 19: Highest document component sequence number, 2 bytes. The maximum value in practice shall never exceed 10,000 (-1), so a field length of 4 characters (in ASCII or EBCDIC) will be sufficient. The space can be found in item 23: position 117-120.

d) Item 49: Length of variable data field, 2 bytes. Although the value can be derived from item 1 (record length in character format - prefix length), it can also be stored in item 6 with the same length of item 1, length 5 characters: position 20-24.

Notes:

In practice, if data is delivered on magnetic tape, the tape label information would normally be in EBCDIC (ISO 1001), even if the prefix information is in ASCII. In such cases the tape label information may be ignored or, more usually, automatically processed by receiving systems.

It is recommend that if the prefix information is in ASCII then the variable text data (SGML data) is also in ASCII and vice versa for EBCDIC data.

IMPLEMENTATION

30. It is recommended that, before information is regularly exchanged between Offices, full discussion should take place as to the exact manner in which this Recommended Standard is implemented, particularly in connection with the information to be recorded under “Other” item numbers 6, 11, 12, 23, 24, 34, 35, 47, 48 of the prefix definition given in “Appendix 2”.

[Appendix 1 follows]

APPENDIX 1

CHARACTER SET FOR LABEL AND RECORD PREFIX CODING (IBM EBCDIC)

Col	0	1	2	3	4	5	6	7	8	9	A	B	C	D	E	F	
Row	Bit	00				01				10				11			
	Pat	00	01	10	11	00	01	10	11	00	01	10	11	00	01	10	11
0	0000					SP		-									0
1	0001							/						A	J		1
2	0010													B	K	S	2
3	0011													C	L	T	3
4	0100													D	M	U	4
5	0101													E	N	V	5
6	0110													F	O	W	6
7	0111													G	P	X	7
8	1000													H	Q	Y	8
9	1001													I	R	Z	9
A	1010																
B	1011							,	#								
C	1100					<	*	%									
D	1101					()	_	'								
E	1110					+	;	>	=								
F	1111							?									

[Appendix 2 follows]

APPENDIX 2

PREFIX ITEM DEFINITION

M/D O/R	Item No.	Field name	Start pos.	Field length	Type
M	0	Internal record length (Record Descriptor Word)	-3	4	Bin
I. PREFIX ITEMS					
M	1	Record length	1	5	Char
M	2	Publication office	6	2	Char
M	3	Kind of document	8	2	Char
M	4	Document number	10	8	Char
O	5	Emperor's year code	18	1	Char
D	6.1	Prefix Character set (<u>A</u> SCII or <u>E</u> B <u>C</u> D <u>I</u> C)	19	1	Char
D	6.2	Length of variable data field (50)	20	5	Char
M	6.3	Version Number	25	2	Char
M	7	Document component type	27	3	Char
M	8	Document component identification number	30	8	Char
M	9	Document component record sequence number	38	2	Bin
O	10	Date of issue of amendment	40	8	Char
O	11	Others (exchange use)	48	15	Char
O	12	Others (domestic use)	63	15	Char
M	13	Originating office	78	2	Char
M	14	Date of production	80	8	Char
M	15	Document status	88	1	Char
M	16	Document component status	89	1	Char
O	17	Highest frame number within page	90	4	Char
O	18	Highest document record sequence number	94	4	Bin
M	19	Highest document component record sequence number	98	2	Bin
D	20	Distinction of revisory document	100	1	Char
O	21	Size of document in height	101	3	Char
O	22	Size of document in width	104	3	Char
D	23.1	Document component record sequence number (item 9 in char. form)	107	4	Char
D	23.2	Highest document record sequence number (item 18 in char. form)	111	6	Char
D	23.3	Highest document component record sequence number (item 19 in char. form)	117	4	Char
O	23.4	Others (exchange use)	121	1	Char
O	24	Others (domestic use)	122	15	Char
M	25	Data type	137	1	Char
O	26	Existence of bibliographic data	138	1	Char
O	27	Existence of claim	139	1	Char
O	28	Existence of drawing	140	1	Char
O	29	Existence of amendment	141	1	Char

Appendix 2, page 2

M/D O/R	Item No.	Field name	Start pos.	Field length	Type
O	30	Existence of description	142	1	Char
O	31	Existence of abstract	143	1	Char
O	32	Existence of search report	144	1	Char
O	33	Existence of abstract drawing	145	1	Char
M	34	Extended document number	146	15	Char
O	35	Others (domestic use)	161	20	Char
M	36	Compression method of image data	181	2	Char
M	37	K-Factor code	183	2	Char
M	38	Resolution	185	2	Char
M	39	Size of frame height	187	3	Char
M	40	Size of frame width	190	3	Char
M	41	Number of lines of frame height	193	4	Char
M	42	Number of lines of frame width	197	4	Char
D	43	Rotation Code	201	1	Char
O	44	Frame location X-axis coordinates	202	4	Char
O	45	Frame location Y-axis Coordinates	206	4	Char
M	46	Fill order of bits in bytes	210	1	Char
O	47	Others (exchange use)	211	20	Char
O	48	Others (domestic use)	231	20	Char
II. VARIABLE DATA FIELD					
M	49	Length of variable data field	251	2	Bin
M	50	Variable data field	253	V	
M : Mandatory D : Desirable O : Optional R : Reserved					

Note: For text data items 26 to 48 inclusive, as defined above, are not applicable. Therefore, for text data only, these are defined as:

M/D O/R	Item No.	Field name	Start pos.	Field length	Type
I. PREFIX ITEMS 26-48 FOR TEXT DATA ONLY					
O	26-33	Other	138	8	Char
M	34	Extended document number	146	15	Char
O	35-48	Other	161	90	Char
M : Mandatory D : Desirable O : Optional R : Reserved					

The value of "Other" may be set to blanks or utilised as required.

Appendix 2, page 3

PREFIX ITEM DESCRIPTION

Item no.	Field name	Description
0	Internal record length (Record descriptor word)	Binary record length indicator which is not always available for application programs. <ul style="list-style-type: none"> • Bytes 1-2 contain the actual length of the logical record plus four bytes in hexadecimal. • Bytes 3-4 contain hexadecimal value x'0000'
1	Record length	For common use on all operating systems; the value is equal to the value of item 0 minus the value 4.
2	Publication office	WIPO Standard ST.3 (Recommended two-letter code for the representation of countries, and of other entities and international organisations issuing or registering industrial property titles) for the office of publication.
3	Kind of document	WIPO Standard ST.16 (Standard code for identification of different kinds of patent documents).
4	Document number	Standard format document publication number. It is strongly recommended that if there is also an application number that this data is entered in one of the "Other" item fields.
5	Emperor's year code	Designation of year for translation to non-JP calendar. The codes currently used are: <p>1 MEIJI 2 TAISHO 3 SHOWA 4 HEISEI</p>
6.1	Prefix character set	This indicates which character set is used for the prefix data: ASCII or EBCDIC: <p>A Bit: "01000001" for ASCII (Character A in ASCII) E Bit: "11000101" for EBCDIC (Character E in EBCDIC)</p>
6.2	Length of variable data field (50)	This is the length of item 50, the part of the record that contains the variable data. The length is in character number format, either in ASCII or in EBCDIC.
6.3	Version Number	The version number of this standard. Value will be 'F2'.
7	Document component type	The codes currently used are:

Appendix 2, page 4

Item no.	Field name	Description
		<p>EMI Embedded image data (frame or whole page)</p> <p>GAI Gaiji dot font file (for use by the JPO)</p> <p>RTI Replacement of Text by Image data</p> <p>TXT Character-code data</p> <p>OCR Character code data obtained by OCR conversion</p> <p>Other values currently unassigned</p>
8	Document component identification number	<p>1. For image records, i.e., where 'item 7' contains: EMI, RTI or OCR, the sequence number may either contain a sequential number incremented in relation to the document identifier or be coded as follows:</p> <p style="padding-left: 40px;">First 4 characters: Page number Last 4 characters: Frame number</p> <p>Obviously, for the same document identifier this field must be coded consistently according to either one of these two methods but NOT both.</p> <p>2. For text records, i.e., where 'item 7' contains 'TXT', the sequence number should, normally, always be 00000001</p>
9	Document component record sequence	Identification of this record with reference to 'Highest document component record sequence number' (Item 19) for this document component.
10	Date of issue of amendment	The date of amendment (YYYYMMDD).
11	Others (exchange use)	Free use by each office for exchange use. Obviously this must be specified for receiving offices.
12	Others (domestic use)	Free use by each office for domestic use.
13	Originating office	The originating office of the text or image capture according to WIPO Standard ST.3 (Recommended two-letter code for the representation of countries, and of other entities and international organisation issuing or registering industrial property titles).
14	Date of production	The date of data capture (YYYYMMDD).

Appendix 2, page 5

Item no.	Field name	Description
15	Document status	The codes currently used are: N New R Replacement D Deletion
16	Document component status	The codes currently used are: N New R Replacement D Deletion M Missing
17	Highest frame number within page	The last 'Frame number' used within the current page number used in item 8 'Document component identification number', i.e., the number of components used within a page.
18	Highest document record sequence number	The total number of physical records used for this document, i.e., for the same: <ul style="list-style-type: none"> • Publication office • Kind of document • Document number • Emperor's year code
19	Highest document component record sequence number	The total number of physical records for this document component, i.e., for the same: <ul style="list-style-type: none"> • Publication office • Kind of document • Document number • Emperor's year code • Document component type • Document component identification number
20	Distinction of revisory document	0 Basic, primary, document 1 Revisory document
21	Size of document in height	Designation of document page size in height given in millimetres (mm).
22	Size of document in width	Designation of document page size in width given in millimetres (mm).
23.1	Document component record sequence number (item 9 in character form)	Identification of this record with reference to 'Highest document component record sequence number' (Item 19) for this document component. The length is in character number format, either in ASCII or EBCDIC.
23.2	Highest document record	The total number of physical records used for this

Appendix 2, page 6

Item no.	Field name	Description
	sequence number (item 18 in character form)	<p>document, i.e., for the same:</p> <ul style="list-style-type: none"> • Publication offices • Kind of document • Document number • Emperor's year code <p>The length is in character number format, either in ASCII or in EBCDIC.</p>
23.3	Highest document component record sequence number (item 19 in character form)	<p>The total number of physical records for this document component, i.e., for the same:</p> <ul style="list-style-type: none"> • Publication offices • Kind of document • Document number • Emperor's year code • Document component type • Document component identification number <p>The length is in character number format, either in ASCII or in EBCDIC.</p>
23.4	Others (exchange use)	Free use by each office for exchange use. Obviously this must be specified for receiving offices.
24	Others (domestic use)	Free use by each office for domestic use.
25	Data type	<p>The codes currently used are:</p> <p>T TEXT 4 GROUP 4 type image C CGM type image G IGES type image F TIFF type image</p>
26-33	Existence of sub-documents	<p>Identification of the type of sub-document in which the image occurs. The codes currently used are:</p> <p>0 Sub-document NOT present 1 Sub-document present Space Not used</p> <p>Image data only.</p>

Appendix 2, page 7

Item no.	Field name	Description
34	Extended document number	Document number as defined for item 4, but allowing more than 8 digits. Field must be always used, also when the document number fits into item 4. Text and image data.
35	Others (domestic use)	Free use by each office for domestic use. Image data only.
36	Compression method of image data	The codes currently used are: MR Modified Read Code (MRC) M2 Modified Read Code II (MRII) Image data only.
37	K-Factor code	Infinite K is represented by the value 99 Image data only.
38	Resolution	The values currently used are: 8 8 lines/mm 12 12 lines/mm 16 16 lines/mm Image data only.
39	Size of frame height	Designation of frame size in millimetres (mm) independent of rotation (Item 43). Image data only.
40	Size of frame width	Designation of frame size in millimetres (mm) independent of rotation (Item 43). Image data only.
41	Number of lines of frame height	Number of scanned lines in height dimension of the frame. Image data only.
42	Number of lines of frame width	Number of scanned lines in width dimension of the frame. Image data only.

Appendix 2, page 8

Item no.	Field name	Description
43	Rotation Code	<p>Designation of angle of frame rotation The codes currently used are:</p> <div data-bbox="852 568 1136 936" style="border: 1px solid black; padding: 10px; margin: 10px auto; width: fit-content;"> <p>1 = ↑ A</p> <p>2 = ← A</p> <p>3 = ↓ V</p> <p>4 = → A</p> </div> <p style="text-align: center;">Space = Not used</p> <p>Image data only.</p>
44-45	Frame location X and Y axis coordinates	<p>X and Y coordinates in tenths (1/10) of millimetres (mm) of frame location with reference to the top left corner of the page. Image data only.</p>
46	Fill order of bits in bytes	<p>The Most Significant Bit (MSB) in a byte is filled first by the data bit stream. Value = M. Image data only.</p>
47	Others (exchange use)	<p>Free use by each office for exchange use. Obviously this must be specified for receiving offices. Image data only.</p>
48	Others (domestic use)	<p>Free use by each office for domestic use.</p>
49	Length of variable data field	<p>Total number of bytes of subsequent data in this physical record.</p>
50	Variable data field	<p>Containing data according to data type: item 25.</p>

[Appendix 3 follows]

APPENDIX 3

FACSIMILE CODING CONVENTION

The coding scheme for the image data is based on the Modified READ II data compression technique for ITU-T (CCITT) Group 4 facsimile equipment as described in the ITU-T (CCITT) recommendation T.6. The following guidelines for processing and control functions are part of this recommendation and should be particularly noted:

- (a) First line coding: The first line coding is two dimensional and its reference line is an imaginary white line;
- (b) Line synchronisation Code: Line synchronisation codes will not be used;
- (c) Frame ending code: The frame ending code will be represented by the End of Facsimile Block (EOFB) code which consists of 2 subsequent End of Line (EOL) codes and is represented by the following 24 bits:

EOFB = 000000000001000000000001;
- (d) Fill bits for lines: Fill bits for lines will not be used;
- (e) Pad bits for frame: Pad bits are to be used after EOFB to align on byte boundaries. Their format is a string of 0s with a length from 1 to 7 bits;
- (f) Method of coding: A Make-up code for a run longer than 2560 is not allowed. Runs longer than 2623 have to be coded by successive Make-up codes plus Terminating code;
- (g) Direction of bit string: The direction of the bit string is from the most significant bit (MSB) to the least significant bit (LSB);
- (h) Compressed mode: All data must be in compressed form. The uncompressed mode will not be used.

[Appendix 4 follows]

APPENDIX 4

TAGGED IMAGE FILE FORMAT (TIFF)

INTRODUCTION

1. Storage of images may be in Tagged Image File Format (TIFF). Images in patent documents can be complete scanned pages or so-called Embedded Images (<EMI>). Embedded images are document parts that cannot be coded and stored using a character set. These <EMI>'s can be drawings, chemical formulae, complex tables, undefined characters, etc. Undefined characters are characters not defined in a character set (or not contained as entity reference - see WIPO ST.32). These are the smallest images.
2. TIFF may be selected for the storage of these images for the following reasons:
 - a) The file structure allows for storage of all kinds of information related to the image. This information is stored in separate tags (see below for a description).
 - b) TIFF is a widely accepted industry standard for storage and processing of images.
 - c) TIFF supports a variety of data compression techniques and resolutions and is flexible in adding new features in a controlled fashion.
 - d) Because of the tagging structure, software products processing these images can as a whole or partly use the information stored in these tags.
 - e) TIFF permits recording single or multiple images in one file.
 - f) The TIFF tagging system satisfies for storage of Identification and Prefix data as required for patent images.
3. Below a description is given about the composition of TIFF files in general and the specific contents of the tags for patent documents.
4. Detailed information about the structure of TIFF can be found in the Microsoft Windows Software Development Kit version 2.0 manual: 'Windows Extensions' chapters 1 through 7. It is available through the courtesy of Hewlett-Packard Company, Greely Division.

Appendix 4, page 2

FILE FORMAT AND TAGGING MECHANISM

FILE FORMAT

1. A TIFF file consists of a header containing general information about the file, a directory containing the tags for each image and the image data. See also the schematic overview below.

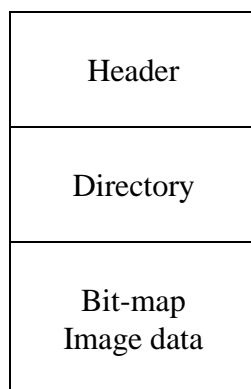

2. A TIFF file contains only one header but may contain more directories and bit-map images. More than one image may be stored in a TIFF file. Each separate image contains its own directory. The first directory is usually placed immediately after the header. The order of the images and subsequent directories is free. Each directory contains a pointer to the next directory (if present). Each directory also contains a pointer to the bit-map image. See also the scheme below.

Appendix 4, page 3

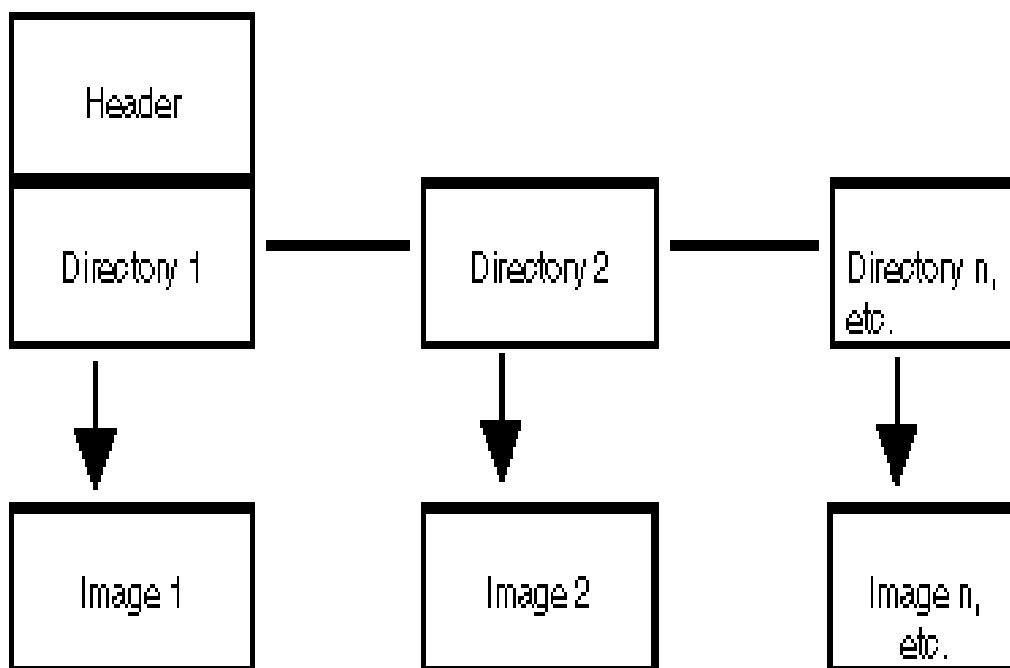

Note: For reason of performance, images are often stored separately in a single TIFF file.

HEADER FORMAT

1. The header contains 3 fields: The Byte Order, the TIFF version number and a pointer to the first directory. A description is given in the table below.

Seq No	Rel Pos Dir	Meaning of item	Content	Bytes	Type Bin Char	Remarks
1	0-1	Byte order	II	2	Ch	II indicates that all binary fields in header directory are recorded in Intel format
2	2-3	TIFF version number	50	2	B	
3	4-7	Pointer to 1st. directory	8	4	B	

Note: The notation for patent documents is in Intel format. The bytes are filled from left to right. So, e.g., information that occupies one byte in a field with a length of 2 bytes, is stored in the left order byte, the right order byte is filled with binary zero's. Fields containing character data always end with a right order byte containing binary zero's as end of data indicator and are therefore one byte longer than the actual size.

Appendix 4, page 4

DIRECTORY AND TAGGING STRUCTURE

1. A directory contains the following data:

a) Number of tags in this directory. This is the total number of tags in this directory. The notation is in binary form.

b) The tags containing information about the image. A further specification will be given below.

c) A pointer to the next directory (if present). Notation in binary form.

d) Tag data not fitting in the tag itself (greater than 4 bytes, see below in tag description). Variable length.

See also the schematic overview below.

Directory Structure

a)	Number of tags (in binary notation).
b)	Tag 1 Tag 2 Tag n, etc.
c)	Pointer to next directory (if any) (in binary notation).
d)	Tag Data not fitting in a tag. (See below for a specification.)

2. A tag consists of 4 fields:

Field 1: Tag identifying number (2 bytes)

Field 2: Data type of the tag (2 bytes). It can have a value from 1 to 5 (in binary notation). The meaning of the values 1 to 5 is:

1 = Byte 8-bit bytes

2 = ASCII 8-bit ASCII codes

3 = Short 16-bit (two byte) unsigned integers

Appendix 4, page 5

4 = Long 32-bit (four byte) unsigned integers

5 = Rational Two longs; the first is the numerator of a fraction, the second is the denominator of a fraction

Field 3: Length. It is 4 bytes long and indicates the length of the data.

Field 4: Value/Offset. This field is 4 bytes long and contains the value of the tag or, when the data is too long (more than 4 bytes), an offset pointer to the field where the tag data is stored.

3. A specification of the contents of the tags for patent documents follows below.

Appendix 4, page 6

CONTENTS OF TAGS FOR PATENT DOCUMENTS

STANDARD TIFF TAGS

In the table below, a specification is given of the TIFF tags in use with the (possible) contents for patents. All tags belong to the standard (mandatory or optional) tag set, except tag 999, which is a private tag. Other private tags for specific purposes are possible (standard TIFF packages ignore these tags). The tags are stored in ascending order of tag identifier.

ID	Meaning of item	Data type	Length	value or pointer	Remarks
254	New subfile type	4	1	0	Indicates that it is a full resolution image. Default value 0.
255	Old subfile type	3	1	1	For compatibility reasons still available.
256	Width of image	3	1	number	In pixels (X direction).
257	Length of image	3	1	number	In pixels (Y direction).
258	Bits per sample	3	1	1	Black and white, 1 bit per sample.
259	Compression method	3	1	4	ITU-T (CCITT) Fax Group 4.
262	Photometric interpretation	3	1	0	Minimum value (0) is white, maximum value (1) is black.
266	Fill order	3	1	1	Left to right.
269	Document name	2	13	xx	xx is a pointer to the document number which is 12 characters long (+1 end byte). For example: an EP document application number is composed as follows: <ul style="list-style-type: none"> • Publication office (2 bytes), • Document kind (2 bytes), • Document number (8 bytes). (The current layout of an EP document publication number is a blank in the first position, followed by a publication number of 7 positions).
270	Image description	2	9	xx	xx is a pointer to the image identification, which consists of a page number (4 positions) and a frame number (4 positions) + 1 end byte.
273	Strip offset	4	1	xx	xx is a pointer to the start of the image data belonging to this directory.

Appendix 4, page 7

ID	Meaning of item	Data type	Length	value or pointer	Remarks
274	Orientation	3	1	1	Rotation code or orientation code (of image) can have the values 1-4, compared with the clock 1=12 hrs, 2=9 hrs, 3=6 hrs and 4=3 hrs.
277	Samples Per Pixel	3	1	1	Black and white.
278	Rows per strip	4	1	number	Number of rows (equal to tag 257, height in pixels).
279	Strip byte count	4	1	number	Number of bytes of image data in uncompressed form.
280	Min sample value	3	1	0	
281	Max sample value	3	1	1	
282	X resolution	5	1	xx	xx is a pointer to the field containing the numerator of the resolution in pixels in x direction, which is 4 bytes long. The value of this field is 300. The denominator follows this field immediately and is also 4 bytes long. The value of this field is 1. The result is a value of 300 DPI in x direction.
283	Y resolution	5	1	xx	Resolution in y direction, see tag 282 for explanation. The value is 300 DPI.
293	Group 4 options	4	1	0	Compressed in ITU-T (CCITT) Gr 4 format.
296	Resolution unit	3	1	2	Inches.
306	Date time	2	20	xx	xx is a pointer to the field containing the Date (YYYY:MM:DD) and the Time (HH:MM:SS).
999	Miscellaneous	2	253	xx	Private field, e.g., for ST.33 header where xx is a pointer to a field containing, for the EPO, the complete ST.33 header of 252 bytes.

[Appendix 5 follows]

APPENDIX 5

EXAMPLES OF CODING MIXED-MODE PATENT DOCUMENTS

EXAMPLE 1

1. This is a sample document from the EPO. It consists of:
 - a) COMPONENT 1 IDENTIFICATION = TXT:
the full text of the patent application, marked up with SGML tags, as captured and as stored on magnetic tape (or any other media). In this example only part of the text (bibliographic data, abstract, description and claims) is shown.

The prefix information for this component.
 - b) COMPONENT 2 IDENTIFICATION = EMI:

the abstract drawing for the front (title) page of the patent.

The prefix information for this component.
 - c) COMPONENT 3 IDENTIFICATION = EMI:

the full page Figure 1 drawing of the drawings

The prefix information for this component.
 - d) COMPONENT 4 IDENTIFICATION = EMI:

the full page Figure 2 drawing of the drawings

The prefix information for this component.
 - e) COMPONENT 5 IDENTIFICATION = EMI:

the full page Figure 3 drawing of the drawings

The prefix information for this component.
 - f) COMPONENT 6 IDENTIFICATION = EMI:

the Search Report, which, in this case, was captured as a full page image.

The prefix information for this component.

Appendix 5, page 2

EXAMPLE 1: Component 1 - type = TXT:

CHARACTER CODED DATA

*Note: All <SGML> tags are printed in bold. Comments are printed in square brackets in [italic bold]. Reference should be made to WIPO ST.32, Revision 3, for a full description of all SGML tags and usage. The SGML tagging shown below is for example only, it is **not** necessarily that used by the EPO.*

[Start of European Patent Document]

<PATDOC FILE=90121107 CY=EP DNUM=0484564 KIND=A1 DATE=19920513>

[Start of bibliographic data for title page]

<SDOBI LA=EN>

<B100>

<B110>0484564

<B120>

<B121>EUROPEAN PATENT APPLICATION

</B120>

<B130>A1

<B140><DATE>19920513

<B190>EP

</B100>

<B200>

<B210>901211078

<B220><DATE>19901105

</B200>

<B400>

<B430><DATE>19920513

<BNUM>1992/20

</B430>

</B400>

<B500>

<B510>

<B511>G01J 3/46

<B512>G06F 15/46

</B510>

<B540>

<B541>En

<B542>Metered color matching method.

</B540>

</B500>

<B700>

<B710>

<B711><ONM>KANSAI PAINT CO. LTD.

<ADR>

<STR>33-1, Kanzaki-cho

<CITY>Amagasaki-shi Hyogo-ken

<CTRY>JP

</ADR>

</B710>

<B720>

<B721><SNM>Yoshino<FNM>Shoichi

<ADR>

<ONM>c/o Kansai Paint Co.,Ltd.

<STR>24-15 Higashichi 5-chome

<STR>Shinagawa-ku

<CITY>Tokyo

<CTRY>JP

</ADR>

</B721>

<B721><SNM>Masai<FNM>Yoshiharu

Appendix 5, page 3

<ADR>
<ONM>c/o Kansai Paint Co. Ltd
<STR>3-6 Fushimi-cho 4-chome
<STR>Chuo-ku, Osaka-shi
<CITY>Osaka
<CTRY>JP
</ADR>
</B721>
<B721><SNM>Hirayama<FNM>Tohru
<ADR>
<ONM>c/o Kansai Paint Co.Ltd.
<STR>17-1 Higashiyawata 4-cho
<STR>Hiratsuka-shi
<CITY>Kanagawa-ken
<CTRY>JP
</ADR>
</B721>
</B720>
<B740>
<B741>Kraus<FNM>Walter<TTL>Dr.<SFX>et al
<ADR>
<ONM>Patentanwälte Kraus, Weisert & Partner
<STR>Thomas-Wimmer-Ring 15
<PCODE>W-8000
<CITY>München 22
<CTRY>DE
</ADR>
</B740>
</B700>
<B800>
<B840><CTRY>DE FR GB NL
</B800>
</SDOBI>
[End of bibliographic data]

Appendix 5, page 4

[Start of abstract data]

<SDOAB LA="EN">

<P> A method of matching a color sample mixing basic paints based on data transmitted to and from a computer via a telephone circuit. Data obtained by measuring a color sample are sent to the computer and data for coloring matching are obtained, and a test color is prepared based on the data for color matching. The observed data obtained by measuring the test color are sent to the computer to obtain correction data. The device for sending the observed data to the computer has a MODEM, an input device, an output device and a display device for presenting calculated weights of basic paints.

[Reference to the abstract drawing image data.

This references the image data held in physical record 3.]

<EMI ID="0.1" HE=112 WI=65 TI=AD>

</SDOAB>

[End of abstract data]

[Start of description data]

<SDODE LA=EN>

<H>Field of the Invention</H>

<P>The present invention relates to a metered color matching method for formulating coating solutions of desired colors for so-called in-store color matching which is performed in end retail stores handling coating compositions and performing repair coating of cars, for example.

<H>Background of the Invention</H>

<P>For example, there might often be subtle differences in paint colors of cars depending on the model, type and the like of individual cars even if the same color name is referred to.

<P>For this reason, upon repairing coating of ...

....

</SDODE>

[End of description data]

[Start of claims data]

<SDOCL LA=EN>

A method of matching color, comprising the steps of:
measuring a color sample using a color meter to obtain observed data on the color sample,
sending the observed data to a computer device via telephone circuit,

.....

</SDOCL>

[End of claims data]

Appendix 5, page 5

[Start of reference to all drawings in the drawings subdocument. This references the image data held in records 3 to 5.]

Note: The LX and LY coordinates are given for the ORIGINAL page, not the published version. Their further use is discretionary.]

<SDODR LA=EN>

<EMI ID="16.1" HE=197 WI=115 LX=552 LY=535 TI=DR>

<EMI ID="17.1" HE=178 WI=131 LX=464 LY=708 TI=DR>

<EMI ID="18.1" HE=217 WI=128 LX=511 LY=542 TI=DR>

[End of drawings]

</SDODR>

[Start of reference to the search report as an image. The actual image is stored in record 6. This data may also be captured as character coded data.]

<SDOSR LA=EN>

<EMI ID="19.1" HE=240 WI=156 LX=332 LY=366 TI=SR>

[End of search report]

</SDOSR>

[End of European Patent Document]

</PATDOC>

Appendix 5, page 6

EXAMPLE 1: Component 1 - type = TXT:

PREFIX ITEMS

Physical record #1

Item No	Field name	Field length	Type	Content
0	Internal record length	4	Bin	x'4E1C0000' (=d'19996)
1	Record length	5	Char	19992
2	Publication office	2	Char	EP
3	Kind of document	2	Char	A1
4	Document number	8	Char	0484564
5	Emperor's year code	1	Char	
6.1	Prefix character set (when ASCII)	1	Char	A
	(when EBCDIC)			E Blank
6.2	Length of variable data field (50)	5	Char	19740
6.3	Version number	2	Char	F2
7	Document component type	3	Char	TXT
8	Document component identification number	8	Char	00000001
9	Document component record sequence number	2	Bin	x'0001'
10	Date of issue of amendment	8	Char	
11	Others (exchange use)	15	Char	
12	Others (domestic use)	15	Char	
13	Originating office	2	Char	EP
14	Date of production	8	Char	19950621
15	Document status	1	Char	N
16	Document component status	1	Char	N
17	Highest frame number within page	4	Char	
18	Highest document record sequence number	4	Bin	x'00000009'
19	Highest document component record sequence number	2	Bin	x'0002'
20	Distinction of revisory bulletin	1	Char	0
21	Size of document in height	3	Char	297
22	Size of document in width	3	Char	196
23.1	Document component record sequence number	4	Char	0001
23.2	Highest document record sequence number	6	Char	000009
23.3	Highest document component record sequence number	4	Char	0002
23.4	Others (exchange use)	1	Char	
24	Others (domestic use)	15	Char	
25	Data type	1	Char	T
26	Existence of bibliographic data	1	Char	
27	Existence of claim	1	Char	
28	Existence of drawing	1	Char	
29	Existence of amendment	1	Char	
30	Existence of description	1	Char	
31	Existence of abstract	1	Char	
32	Existence of search report	1	Char	
33	Existence of abstract drawing	1	Char	
34	Extended document number	15	Char	0484564 *)
35	Others (domestic use)	20	Char	
36	Compression method of image data	2	Char	
37	K-Factor code	2	Char	

Appendix 5, page 7

Item No	Field name	Field length	Type	Content
38	Resolution	2	Char	
39	Size of frame height	3	Char	
40	Size of frame width	3	Char	
41	Number of lines of frame height	4	Char	
42	Number of lines of frame width	4	Char	
43	Rotation Code	1	Char	
44	Frame location X-axis coordinates	4	Char	
45	Frame location Y-axis Coordinates	4	Char	
46	Fill order of bits in bytes	1	Char	
47	Others (exchange use)	20	Char	
48	Others (domestic use)	20	Char	
49	Length of variable data field	2	Bin	x'4D1C' (=d'19740')
50	Variable data field	V		<PATDOC> ...

Note: The document text data is greater than 20k therefore two physical records are created.

*) The number is right justified and extended with leading blanks.

Appendix 5, page 8

EXAMPLE 1: Component 1 - type = TXT:

PREFIX ITEMS

Physical record #2

Item No	Field name	Field length	Type	Content
0	Internal record length	4	Bin	x'1C390000' (=d'7225')
1	Record length	5	Char	07221
2	Publication office	2	Char	EP
3	Kind of document	2	Char	A1
4	Document number	8	Char	0484564
5	Emperor's year code	1	Char	
6.1	Prefix character set (when ASCII) ----- (when EBCDIC)	1	Char	A ----- E Blank
6.2	Length of variable data field (50)	5	Char	06969
6.3	Version number	2	Char	F2
7	Document component type	3	Char	TXT
8	Document component identification number	8	Char	00000001
9	Document component record sequence number	2	Bin	x'0002'
10	Date of issue of amendment	8	Char	
11	Others (exchange use)	15	Char	
12	Others (domestic use)	15	Char	
13	Originating office	2	Char	EP
14	Date of production	8	Char	19950621
15	Document status	1	Char	N
16	Document component status	1	Char	N
17	Highest frame number within page	4	Char	
18	Highest document record sequence number	4	Bin	x'00000009'
19	Highest document component record sequence number	2	Bin	x'0002'
20	Distinction of revisory bulletin	1	Char	0
21	Size of document in height	3	Char	210
22	Size of document in width	3	Char	196
23.1	Document component record sequence number	4	Char	0002
23.2	Highest document record sequence number	6	Char	000009
23.3	Highest document component record sequence number	4	Char	0002
23.4	Others (exchange use)	1	Char	
24	Others (domestic use)	15	Char	
25	Data type	1	Char	T
26	Existence of bibliographic data	1	Char	
27	Existence of claim	1	Char	
28	Existence of drawing	1	Char	
29	Existence of amendment	1	Char	
30	Existence of description	1	Char	
31	Existence of abstract	1	Char	
32	Existence of search report	1	Char	
33	Existence of abstract drawing	1	Char	
34	Extended document number	15	Char	0484564 *)
35	Others (domestic use)	20	Char	
36	Compression method of image data	2	Char	
37	K-Factor code	2	Char	

Appendix 5, page 9

Item No	Field name	Field length	Type	Content
38	Resolution	2	Char	
39	Size of frame height	3	Char	
40	Size of frame width	3	Char	
41	Number of lines of frame height	4	Char	
42	Number of lines of frame width	4	Char	
43	Rotation Code	1	Char	
44	Frame location X-axis coordinates	4	Char	
45	Frame location Y-axis Coordinates	4	Char	
46	Fill order of bits in bytes	1	Char	
47	Others (exchange use)	20	Char	
48	Others (domestic use)	20	Char	
49	Length of variable data field	2	Bin	x'1B39' (=d'6969')
50	Variable data field	V		... </PATDOC>



*) The number is right justified and extended with leading blanks.

Appendix 5, page 10

EXAMPLE 1: Component 2 - type = EMI:

IMAGE DATA

The following abstract drawing from the title page is captured and indexed: (The drawing is a REDUCED version of the Figure 1 drawing. All the images shown are NOT TO SCALE).

	<p>Europäisches Patentamt European Patent Office Office européen des brevets</p>	 Publication number: 0 484 564 A1
<p>EUROPEAN PATENT APPLICATION</p>		
<p>Application number: 90121107.8</p>	<p>Int. Cl.⁵: G01J 3/46, G06F 15/46</p>	
<p>Date of filing: 05.11.90</p>		
<p>Date of publication of application: 13.05.92 Bulletin 92/20</p> <p>Designated Contracting States: DE FR GB NL</p> <p>Applicant: KANSAI PAINT CO. LTD. 33-1, Kanzaki-cho Amagasaki-shi Hyogo-ken(JP)</p> <p>Inventor: Yoshino, Shoichi c/o Kansai Paint Co.,Ltd.,24-15 Higashichi 5-chome Shinagawa-ku, Tokyo(JP)</p>	<p>Inventor: Masai, Yoshiharu c/o Kansai Paint Co.,Ltd.,3-6 Fushimi-cho 4-chome Chuo-ku, Osaka-shi, Osaka(JP)</p> <p>Inventor: Hirayama, Tohru c/o Kansai Paint Co.,Ltd.,17-1 Higashiyawata 4-cho Hiratsuka-shi, Kanagawa-ken(JP)</p> <p>Representative: Kraus, Walter, Dr. et al Patentanwälte Kraus, Weisert & Partner Thomas-Wimmer-Ring 15 W-8000 München 22(DE)</p>	

54 Metered color matching method.

57 A method of matching a color sample mixing basic paints based on data transmitted to and from a computer via a telephone circuit. Data obtained by measuring a color sample are sent to the computer and data for coloring matching are obtained, and a test color is prepared based on the data for color matching. The observed data obtained by measuring the test color are sent to the computer to obtain correction data. The device for sending the observed data to the computer has a MODEM, an input device, an output device and a display device for presenting calculated weights of basic paints.

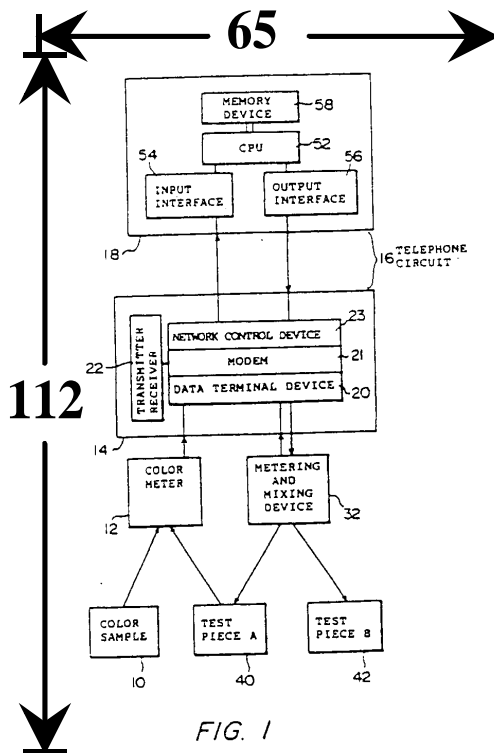

EP 0 484 564 A1

FIG. 1

Appendix 5, page 11

EXAMPLE 1: Component 2 - type = EMI:

PREFIX ITEMS

Physical record #3

Item No	Field name	Field length	Type	Content
0	Internal record length	4	Bin	x'1C1D0000' (=d'7197')
1	Record length	5	Char	07193
2	Publication office	2	Char	EP
3	Kind of document	2	Char	A1
4	Document number	8	Char	0484564
5	Emperor's year code	1	Char	
6.1	Prefix character set (when ASCII)	1	Char	A
	(when EBCDIC)			E Blank
6.2	Length of variable data field (50)	5	Char	06941
6.3	Version number	2	Char	F2
7	Document component type	3	Char	EMI
8	Document component identification number	8	Char	00000001
9	Document component record sequence number	2	Bin	x'0001'
10	Date of issue of amendment	8	Char	
11	Others (exchange use)	15	Char	
12	Others (domestic use)	15	Char	
13	Originating office	2	Char	EP
14	Date of production	8	Char	19950621
15	Document status	1	Char	N
16	Document component status	1	Char	N
17	Highest frame number within page	4	Char	
18	Highest document record sequence number	4	Bin	x'00000009'
19	Highest document component record sequence number	2	Bin	x'0001'
20	Distinction of revisory bulletin	1	Char	0
21	Size of document in height	3	Char	297
22	Size of document in width	3	Char	210
23.1	Document component record sequence number	4	Char	0001
23.2	Highest document record sequence number	6	Char	000009
23.3	Highest document component record sequence number	4	Char	0001
23.4	Others (exchange use)	1	Char	
24	Others (domestic use)	15	Char	
25	Data type	1	Char	4
26	Existence of bibliographic data	1	Char	0
27	Existence of claim	1	Char	0
28	Existence of drawing	1	Char	0
29	Existence of amendment	1	Char	0
30	Existence of description	1	Char	0
31	Existence of abstract	1	Char	1
32	Existence of search report	1	Char	0
33	Existence of abstract drawing	1	Char	1
34	Extended document number	15	Char	0484564 *)
35	Others (domestic use)	20	Char	
36	Compression method of image data	2	Char	M2
37	K-Factor code	2	Char	99

Appendix 5, page 12

Item No	Field name	Field length	Type	Content
38	Resolution	2	Char	12
39	Size of frame height	3	Char	112
40	Size of frame width	3	Char	065
41	Number of lines of frame height	4	Char	1328
42	Number of lines of frame width	4	Char	0768
43	Rotation Code	1	Char	1
44	Frame location X-axis coordinates	4	Char	0000
45	Frame location Y-axis Coordinates	4	Char	0000
46	Fill order of bits in bytes	1	Char	M
47	Others (exchange use)	20	Char	
48	Others (domestic use)	20	Char	
49	Length of variable data field	2	Bin	x'1B1D' (=d'6941')
50	Variable data field	V		Image data

*) The number is right justified and extended with leading blanks.

Appendix 5, page 13

EXAMPLE 1: Component 3 - type = EMI:

IMAGE DATA

The first drawing (Fig. 1) from the drawings subdocument:

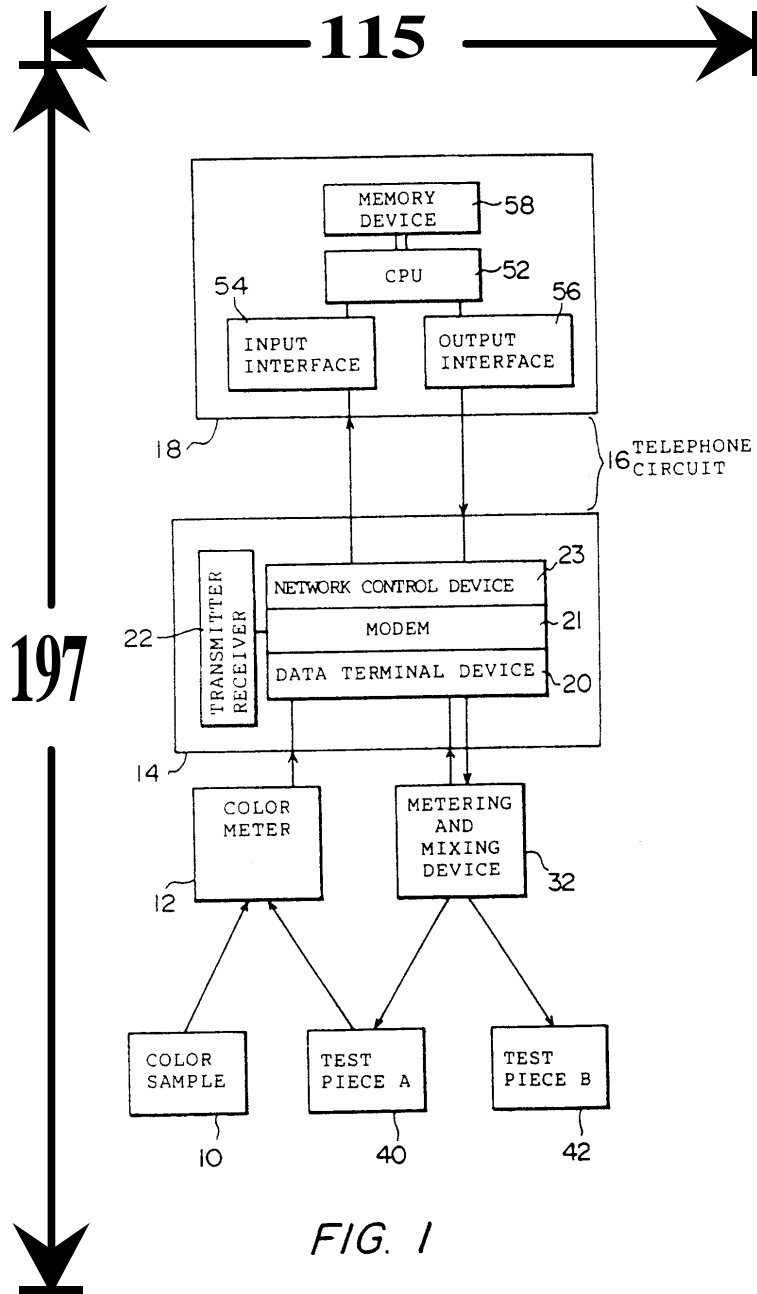

Appendix 5, page 14

EXAMPLE 1: Component 3 - type = EMI:

PREFIX ITEMS

Physical record #4

Item No	Field name	Field length	Type	Content
0	Internal record length	4	Bin	x'3010000' (d='12304')
1	Record length	5	Char	12300
2	Publication office	2	Char	EP
3	Kind of document	2	Char	A1
4	Document number	8	Char	0484564
5	Emperor's year code	1	Char	
6.1	Prefix character set (when ASCII)	1	Char	A
	(when EBCDIC)			E Blank
6.2	Length of variable data field (50)	5	Char	12048
6.3	Version number	2	Char	F2
7	Document component type	3	Char	EMI
8	Document component identification number	8	Char	00160001
9	Document component record sequence number	2	Bin	x'0001'
10	Date of issue of amendment	8	Char	
11	Others (exchange use)	15	Char	
12	Others (domestic use)	15	Char	
13	Originating office	2	Char	EP
14	Date of production	8	Char	19950621
15	Document status	1	Char	N
16	Document component status	1	Char	N
17	Highest frame number within page	4	Char	
18	Highest document record sequence number	4	Bin	x'00000009'
19	Highest document component record sequence number	2	Bin	x'0001'
20	Distinction of revisory bulletin	1	Char	0
21	Size of document in height	3	Char	297
22	Size of document in width	3	Char	210
23.1	Document component record sequence number	4	Char	0001
23.2	Highest document record sequence number	6	Char	000009
23.3	Highest document component record sequence number	4	Char	0001
23.4	Others (exchange use)	1	Char	
24	Others (domestic use)	15	Char	
25	Data type	1	Char	4
26	Existence of bibliographic data	1	Char	0
27	Existence of claim	1	Char	0
28	Existence of drawing	1	Char	1
29	Existence of amendment	1	Char	0
30	Existence of description	1	Char	0
31	Existence of abstract	1	Char	0
32	Existence of search report	1	Char	0
33	Existence of abstract drawing	1	Char	0
34	Extended document number	15	Char	0484564 *)
35	Others (domestic use)	20	Char	
36	Compression method of image data	2	Char	M2
37	K-Factor code	2	Char	99

Appendix 5, page 15

Item No	Field name	Field length	Type	Content
38	Resolution	2	Char	12
39	Size of frame height	3	Char	197
40	Size of frame width	3	Char	115
41	Number of lines of frame height	4	Char	2332
42	Number of lines of frame width	4	Char	1376
43	Rotation Code	1	Char	1
44	Frame location X-axis coordinates	4	Char	0552
45	Frame location Y-axis Coordinates	4	Char	0535
46	Fill order of bits in bytes	1	Char	M
47	Others (exchange use)	20	Char	
48	Others (domestic use)	20	Char	
49	Length of variable data field	2	Bin	x'2F10' (=d'12048')
50	Variable data field	V		Image data

*) The number is right justified and extended with leading blanks.

Appendix 5, page 16

EXAMPLE 1: Component 4 - type = EMI:

IMAGE DATA

The second drawing (Fig. 2) from the drawings subdocument:

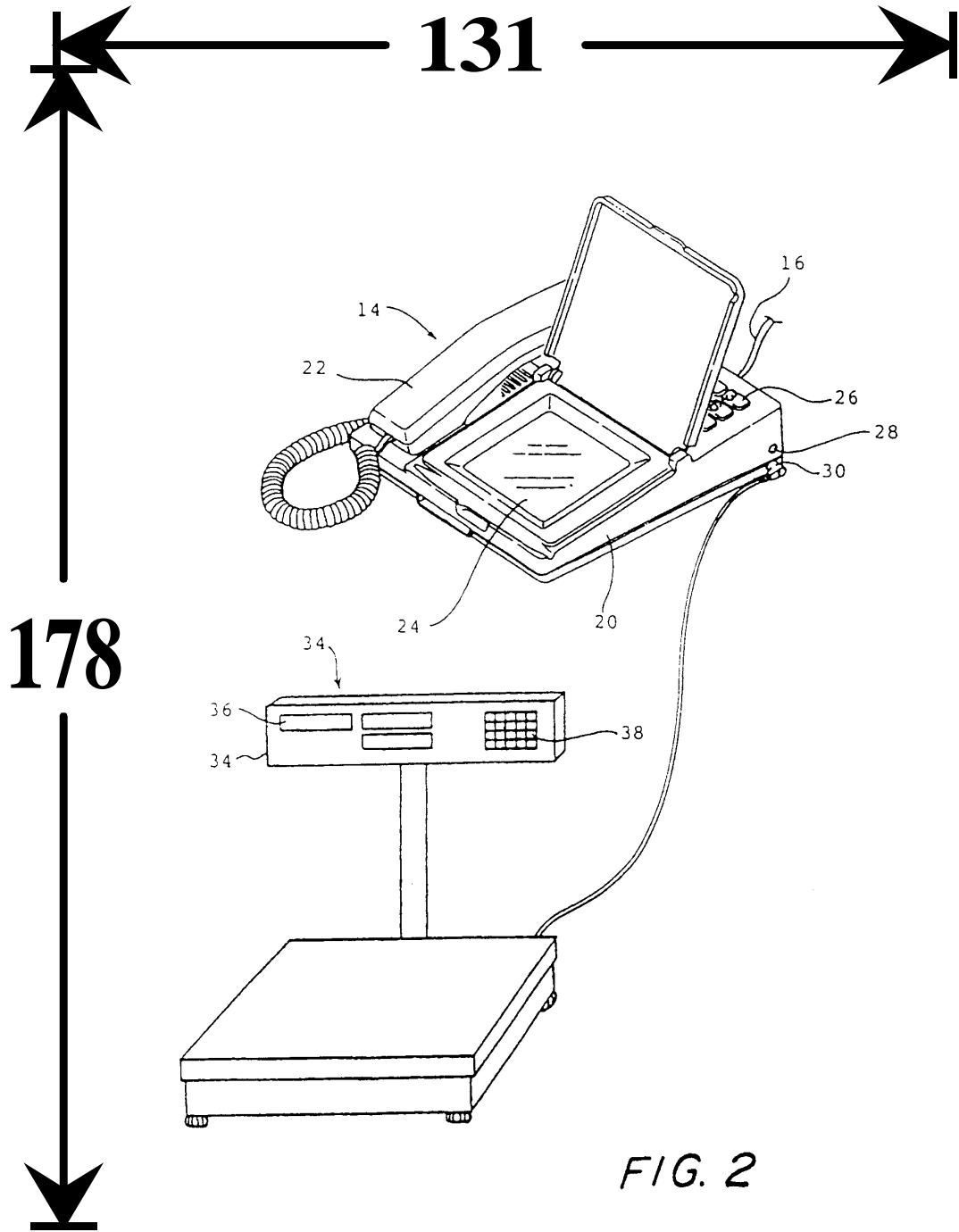

Appendix 5, page 17

EXAMPLE 1: Component 4 - type = EMI:

PREFIX ITEMS

Physical record #5

Item No	Field name	Field length	Type	Content
0	Internal record length	4	Bin	x'3CEB0000' (=d'15595')
1	Record length	5	Char	15591
2	Publication office	2	Char	EP
3	Kind of document	2	Char	A1
4	Document number	8	Char	0484564
5	Emperor's year code	1	Char	
6.1	Prefix character set (when ASCII)	1	Char	A
	(when EBCDIC)			E Blank
6.2	Length of variable data field (50)	5	Char	15339
6.3	Version number	2	Char	F2
7	Document component type	3	Char	EMI
8	Document component identification number	8	Char	00170001
9	Document component record sequence number	2	Bin	x'0001'
10	Date of issue of amendment	8	Char	
11	Others (exchange use)	15	Char	
12	Others (domestic use)	15	Char	
13	Originating office	2	Char	EP
14	Date of production	8	Char	19950621
15	Document status	1	Char	N
16	Document component status	1	Char	N
17	Highest frame number within page	4	Char	
18	Highest document record sequence number	4	Bin	x'00000009'
19	Highest document component record sequence number	2	Bin	x'0001'
20	Distinction of revisory bulletin	1	Char	0
21	Size of document in height	3	Char	297
22	Size of document in width	3	Char	210
23.1	Document component record sequence number	4	Char	0001
23.2	Highest document record sequence number	6	Char	000009
23.3	Highest document component record sequence number	4	Char	0001
23.4	Others (exchange use)	1	Char	
24	Others (domestic use)	15	Char	
25	Data type	1	Char	4
26	Existence of bibliographic data	1	Char	0
27	Existence of claim	1	Char	0
28	Existence of drawing	1	Char	1
29	Existence of amendment	1	Char	0
30	Existence of description	1	Char	0
31	Existence of abstract	1	Char	0
32	Existence of search report	1	Char	0
33	Existence of abstract drawing	1	Char	0
34	Extended document number	15	Char	0484564 *)
35	Others (domestic use)	20	Char	
36	Compression method of image data	2	Char	M2

Appendix 5, page 18

Item No	Field name	Field length	Type	Content
37	K-Factor code	2	Char	99
38	Resolution	2	Char	12
39	Size of frame height	3	Char	178
40	Size of frame width	3	Char	131
41	Number of lines of frame height	4	Char	2100
42	Number of lines of frame width	4	Char	1568
43	Rotation Code	1	Char	1
44	Frame location X-axis coordinates	4	Char	0464
45	Frame location Y-axis Coordinates	4	Char	0708
46	Fill order of bits in bytes	1	Char	M
47	Others (exchange use)	20	Char	
48	Others (domestic use)	20	Char	
49	Length of variable data field	2	Bin	x'3BEB' (=d'15339')
50	Variable data field	V		Image data

*) The number is right justified and extended with leading blanks.

EXAMPLE 1: Component 5 - type = EMI:

IMAGE DATA

The third drawing (Fig. 3) from the drawings subdocument:

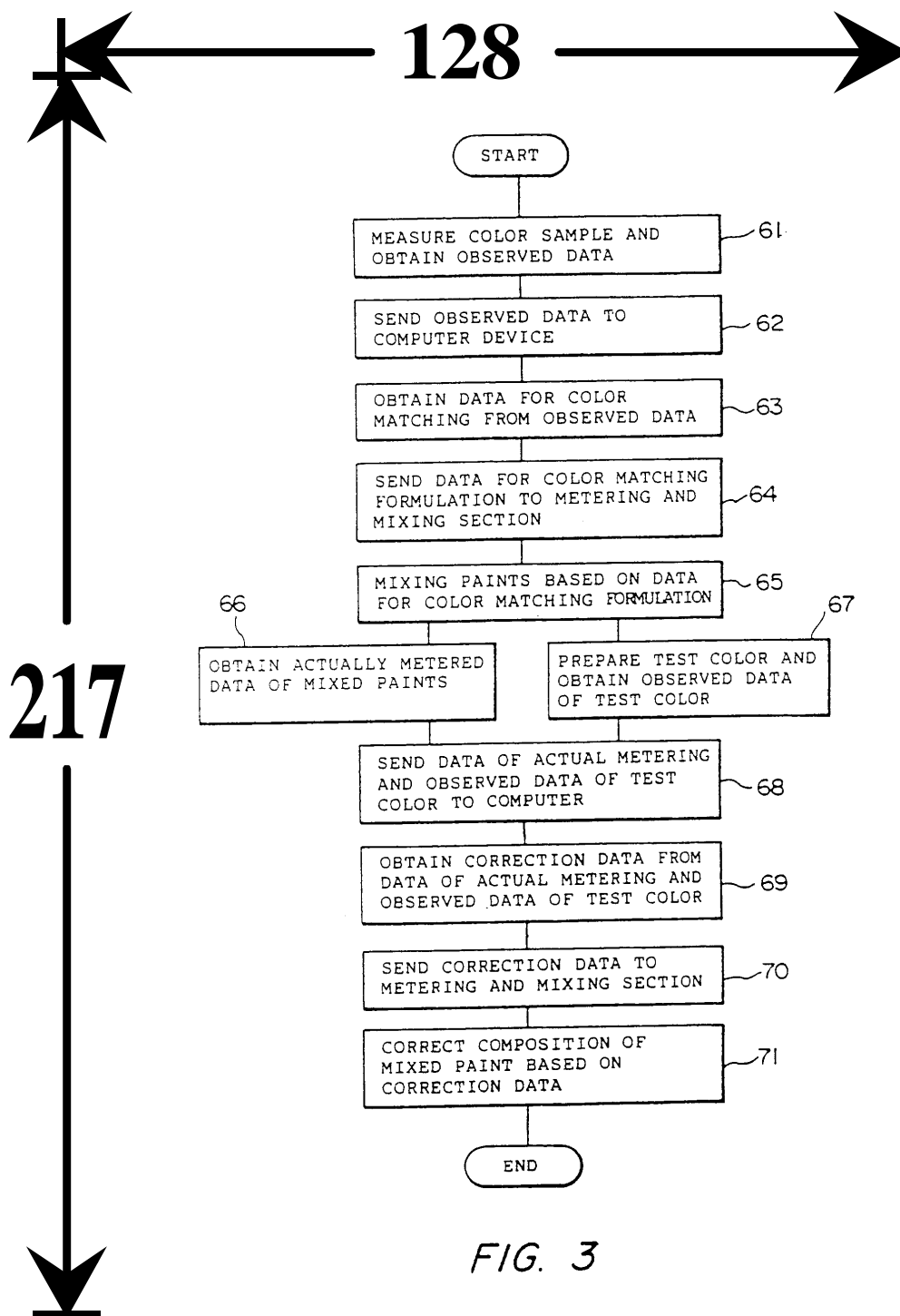

FIG. 3

Appendix 5, page 20

EXAMPLE 1: Component 5 - type = EMI:

PREFIX ITEMS

Physical record #6

Item No	Field name	Field Length	Type	Content
0	Internal record length	4	Bin	x'4E1C0000' (=d'19996')
1	Record length	5	Char	19992
2	Publication office	2	Char	EP
3	Kind of document	2	Char	A1
4	Document number	8	Char	0484564
5	Emperor's year code	1	Char	
6.1	Prefix character set (when ASCII)	1	Char	A
	(when EBCDIC)			E Blank
6.2	Length of variable data field (50)	5	Char	19740
6.3	Version number	2	Char	F2
7	Document component type	3	Char	EMI
8	Document component identification number	8	Char	00180001
9	Document component record sequence number	2	Bin	x'0001'
10	Date of issue of amendment	8	Char	
11	Others (exchange use)	15	Char	
12	Others (domestic use)	15	Char	
13	Originating office	2	Char	EP
14	Date of production	8	Char	19950621
15	Document status	1	Char	N
16	Document component status	1	Char	N
17	Highest frame number within page	4	Char	
18	Highest document record sequence number	4	Bin	x'00000009'
19	Highest document component record sequence number	2	Bin	x'0002'
20	Distinction of revisory bulletin	1	Char	0
21	Size of document in height	3	Char	297
22	Size of document in width	3	Char	210
23.1	Document component record sequence number	4	Char	0001
23.2	Highest document record sequence number	6	Char	000009
23.3	Highest document component record sequence number	4	Char	0002
23.4	Others (exchange use)	1	Char	
24	Others (domestic use)	15	Char	
25	Data type	1	Char	4
26	Existence of bibliographic data	1	Char	0
27	Existence of claim	1	Char	0
28	Existence of drawing	1	Char	1
29	Existence of amendment	1	Char	0
30	Existence of description	1	Char	0
31	Existence of abstract	1	Char	0
32	Existence of search report	1	Char	0
33	Existence of abstract drawing	1	Char	0
34	Extended document number	15	Char	0484564 *)
35	Others (domestic use)	20	Char	
36	Compression method of image data	2	Char	M2
37	K-Factor code	2	Char	99

Appendix 5, page 21

Item No	Field name	Field Length	Type	Content
38	Resolution	2	Char	12
39	Size of frame height	3	Char	217
40	Size of frame width	3	Char	128
41	Number of lines of frame height	4	Char	2564
42	Number of lines of frame width	4	Char	1536
43	Rotation Code	1	Char	1
44	Frame location X-axis coordinates	4	Char	0511
45	Frame location Y-axis Coordinates	4	Char	0542
46	Fill order of bits in bytes	1	Char	M
47	Others (exchange use)	20	Char	
48	Others (domestic use)	20	Char	
49	Length of variable data field	2	Bin	x'4D1C' (=d'19740')
50	Variable data field	V		Image data

Note: The document image data for the third drawing (Fig. 3) is greater than 20k therefore two physical records are created.

*) The number is right justified and extended with leading blanks.

Appendix 5, page 22

EXAMPLE 1: Component 5 - type = EMI:

PREFIX ITEMS

Physical record #7

Item No	Field name	Field length	Type	Content
0	Internal record length	4	Bin	x'08440000' (=d'2116')
1	Record length	5	Char	02112
2	Publication office	2	Char	EP
3	Kind of document	2	Char	A1
4	Document number	8	Char	0484564
5	Emperor's year code	1	Char	
6.1	Prefix character set (when ASCII)	1	Char	A
	(when EBCDIC)			E Blank
6.2	Length of variable data field (50)	5	Char	01860
6.3	Version number	2	Char	F2
7	Document component type	3	Char	EMI
8	Document component identification number	8	Char	00180001
9	Document component record sequence number	2	Bin	x'0002'
10	Date of issue of amendment	8	Char	
11	Others (exchange use)	15	Char	
12	Others (domestic use)	15	Char	
13	Originating office	2	Char	EP
14	Date of production	8	Char	19950621
15	Document status	1	Char	N
16	Document component status	1	Char	N
17	Highest frame number within page	4	Char	
18	Highest document record sequence number	4	Bin	x'00000009'
19	Highest document component record sequence number	2	Bin	x'0002'
20	Distinction of revisory bulletin	1	Char	0
21	Size of document in height	3	Char	297
22	Size of document in width	3	Char	210
23.1	Document component record sequence number	4	Char	0002
23.2	Highest document record sequence number	6	Char	000009
23.3	Highest document component record sequence number	4	Char	0002
23.4	Others (exchange use)	1	Char	
24	Others (domestic use)	15	Char	
25	Data type	1	Char	4
26	Existence of bibliographic data	1	Char	0
27	Existence of claim	1	Char	0
28	Existence of drawing	1	Char	1
29	Existence of amendment	1	Char	0
30	Existence of description	1	Char	0
31	Existence of abstract	1	Char	0
32	Existence of search report	1	Char	0
33	Existence of abstract drawing	1	Char	0
34	Extended document number	15	Char	0484564 *)
35	Others (domestic use)	20	Char	
36	Compression method of image data	2	Char	M2

Appendix 5, page 23

Item No	Field name	Field length	Type	Content
37	K-Factor code	2	Char	99
38	Resolution	2	Char	12
39	Size of frame height	3	Char	217
40	Size of frame width	3	Char	128
41	Number of lines of frame height	4	Char	2564
42	Number of lines of frame width	4	Char	1536
43	Rotation Code	1	Char	1
44	Frame location X-axis coordinates	4	Char	0511
45	Frame location Y-axis Coordinates	4	Char	0542
46	Fill order of bits in bytes	1	Char	M
47	Others (exchange use)	20	Char	
48	Others (domestic use)	20	Char	
49	Length of variable data field	2	Bin	x'0744' (=d'1860')
50	Variable data field	V		Image data

*) The number is right justified and extended with leading blanks.

EXAMPLE 1: Component 6 - type = EMI: IMAGE DATA

The Search report:



European Patent
Office

EUROPEAN SEARCH REPORT

Application Number

EP 90 12 1107

DOCUMENTS CONSIDERED TO BE RELEVANT			
Category	Citation of document with indication, where appropriate, of relevant passages	Relevant to claim	CLASSIFICATION OF THE APPLICATION (Int. Cl.5)
Y	GB-A-2 192 455 (JONES-BLAIR) * abstract * * page 2, line 74 - line 92; figure 1 * * page 3, line 52 - line 74 * ---	1,4	G01J3/46 G06F15/46
Y	PATENT ABSTRACTS OF JAPAN vol. 12, no. 18 (M-660)(2865) January 20, 1988 & JP-A-62 178 346 (ISHIZAKA SHOJI) August 5, 1987 * the whole document * ---	1,4	
A	EP-A-0 251 520 (BUDDY SYSTEMS) * abstract; figure 1 * ---	1-3	
A	US-A-4 403 866 (FALCOFF) * column 4, line 52 - column 5, line 6 * * figure 1 * * column 5, line 57 - line 64 * ---	1,4	
A	EP-A-0 319 375 (DAVID) -----		
			TECHNICAL FIELDS SEARCHED (Int. Cl.5)
			G01J G06F
The present search report has been drawn up for all claims			
Place of search THE HAGUE		Date of completion of the search 17 JUNE 1991	Examiner THOMAS R. M.
CATEGORY OF CITED DOCUMENTS		T : theory or principle underlying the invention F : earlier patent document, but published on, or after the filing date D : document cited in the application I : document cited for other reasons ----- & : member of the same patent family, corresponding document	
X : particularly relevant if taken alone Y : particularly relevant if combined with another document of the same category A : technological background O : non-written disclosure P : intermediate document			

240

EPO FORM 1503 (03.87) (P0401)

Appendix 5, page 25

EXAMPLE 1: Component 6 - type = EMI:

PREFIX ITEMS

Physical record #8

Item No	Field name	Field Length	Type	Content
0	Internal record length	4	Bin	x'4E1C0000' (=d'19996')
1	Record length	5	Char	19992
2	Publication office	2	Char	EP
3	Kind of document	2	Char	A1
4	Document number	8	Char	0484564
5	Emperor's year code	1	Char	
6.1	Prefix character set (when ASCII)	1	Char	A
	(when EBCDIC)			E Blank
6.2	Length of variable data field (50)	5	Char	19740
6.3	Version number	2	Char	F2
7	Document component type	3	Char	EMI
8	Document component identification number	8	Char	00190001
9	Document component record sequence number	2	Bin	x'0001'
10	Date of issue of amendment	8	Char	
11	Others (exchange use)	15	Char	
12	Others (domestic use)	15	Char	
13	Originating office	2	Char	EP
14	Date of production	8	Char	19950621
15	Document status	1	Char	N
16	Document component status	1	Char	N
17	Highest frame number within page	4	Char	
18	Highest document record sequence number	4	Bin	x'00000009'
19	Highest document component record sequence number	2	Bin	x'0002'
20	Distinction of revisory bulletin	1	Char	0
21	Size of document in height	3	Char	297
22	Size of document in width	3	Char	210
23.1	Document component record sequence number	4	Char	0001
23.2	Highest document record sequence number	6	Char	000009
23.3	Highest document component record sequence number	4	Char	0002
23.4	Others (exchange use)	1	Char	
24	Others (domestic use)	15	Char	
25	Data type	1	Char	4
26	Existence of bibliographic data	1	Char	0
27	Existence of claim	1	Char	0
28	Existence of drawing	1	Char	0
29	Existence of amendment	1	Char	0
30	Existence of description	1	Char	0
31	Existence of abstract	1	Char	0
32	Existence of search report	1	Char	1
33	Existence of abstract drawing	1	Char	0
34	Extended document number	15	Char	0484564 *)
35	Others (domestic use)	20	Char	
36	Compression method of image data	2	Char	M2

Appendix 5, page 26

Item No	Field name	Field Length	Type	Content
37	K-Factor code	2	Char	99
38	Resolution	2	Char	12
39	Size of frame height	3	Char	240
40	Size of frame width	3	Char	156
41	Number of lines of frame height	4	Char	2836
42	Number of lines of frame width	4	Char	1856
43	Rotation Code	1	Char	1
44	Frame location X-axis coordinates	4	Char	0332
45	Frame location Y-axis Coordinates	4	Char	0366
46	Fill order of bits in bytes	1	Char	M
47	Others (exchange use)	20	Char	
48	Others (domestic use)	20	Char	
49	Length of variable data field	2	Bin	x'4D1C' (=d'19740')
50	Variable data field	V		Image data

Note: The document image data for the Search Report is greater than 20k therefore two physical records are created.

*) The number is right justified and extended with leading blanks.

Appendix 5, page 27

EXAMPLE 1: Component 6 - type = EMI:

PREFIX ITEMS

Physical record #9

Item No	Field name	Field length	Type	Content
0	Internal record length	4	Bin	x'1F670000' (=d'8039')
1	Record length	5	Char	08035
2	Publication office	2	Char	EP
3	Kind of document	2	Char	A1
4	Document number	8	Char	0484564
5	Emperor's year code	1	Char	
6.1	Prefix character set (when ASCII)	1	Char	A
	(when EBCDIC)			E Blank
6.2	Length of variable data field (50)	5	Char	07783
6.3	Version number	2	Char	F2
7	Document component type	3	Char	EMI
8	Document component identification number	8	Char	00190001
9	Document component record sequence number	2	Bin	x'0002'
10	Date of issue of amendment	8	Char	
11	Others (exchange use)	15	Char	
12	Others (domestic use)	15	Char	
13	Originating office	2	Char	EP
14	Date of production	8	Char	19950621
15	Document status	1	Char	N
16	Document component status	1	Char	N
17	Highest frame number within page	4	Char	
18	Highest document record sequence number	4	Bin	x'00000009'
19	Highest document component record sequence number	2	Bin	x'0002'
20	Distinction of revisory bulletin	1	Char	0
21	Size of document in height	3	Char	297
22	Size of document in width	3	Char	210
23.1	Document component record sequence number	4	Char	0002
23.2	Highest document record sequence number	6	Char	000009
23.3	Highest document component record sequence number	4	Char	0002
23.4	Others (exchange use)	1	Char	
24	Others (domestic use)	15	Char	
25	Data type	1	Char	4
26	Existence of bibliographic data	1	Char	0
27	Existence of claim	1	Char	0
28	Existence of drawing	1	Char	0
29	Existence of amendment	1	Char	0
30	Existence of description	1	Char	0
31	Existence of abstract	1	Char	0
32	Existence of search report	1	Char	1
33	Existence of abstract drawing	1	Char	0
34	Extended document number	15	Char	0484564 *)
35	Others (domestic use)	20	Char	
36	Compression method of image data	2	Char	M2
37	K-Factor code	2	Char	99

Appendix 5, page 28

Item No	Field name	Field length	Type	Content
38	Resolution	2	Char	12
39	Size of frame height	3	Char	240
40	Size of frame width	3	Char	156
41	Number of lines of frame height	4	Char	2836
42	Number of lines of frame width	4	Char	1856
43	Rotation Code	1	Char	1
44	Frame location X-axis coordinates	4	Char	0332
45	Frame location Y-axis Coordinates	4	Char	0366
46	Fill order of bits in bytes	1	Char	M
47	Others (exchange use)	20	Char	
48	Others (domestic use)	20	Char	
49	Length of variable data field	2	Bin	x'1E67' (=d'7783')
50	Variable data field	V		Image data

*) The number is right justified and extended with leading blanks.

Appendix 5, page 29

EXAMPLE 2

Component 1 - type = TXT:

CHARACTER CODED DATA

Note: Only the data from the title page and the first page of the printed patent are printed below.

<PATDOC FILE=90121267 CY=EP DNUM=0484573 KIND=A1 DATE=19920513>
<SDOBI LA=EN>
<B100>
<B110>0484573
<B120>
<B121>EUROPEAN PATENT APPLICATION
</B120>
<B130>A1
<B140><DATE>19920513
<B190>EP
</B100>
<B200>
<B210>901212670
<B220><DATE>19901107
</B200>
<B400>
<B430><DATE>19920513
<BNUM>1992/20
</B430>
<B500>
<B510>
<B511>C07D 487/04
<B512>C07D 209/34
<B512>A61K 31/40
</B510>
<B520>
<B521>(C07D487/04, 209:00, 209:00)
</B520>
<B540>
<B541>En
<B542>4- and 6-Carbamates related to physostigmine, a process and intermediates for their preparation and their use as medicaments.
</B540>
</B500>
<B700>
<B710>
<B711><ONM>HOECHST-ROUSSEL PHARMACEUTICALS INCORPORATED
<ADR>
<STR>Route 202-206 North
54<CITY>Somerville
<STATE>New Jersey

Appendix 5, page 30

<PCODE>08876
<CTRY>US
</ADR>
</B710>
<B720>
<B721><SNM>Glamkowski<FNM>Edward J.
<ADR>
<STR>7 Owens Drive
<CITY>Warren
<PCODE>NJ 07060
<CTRY>US
</ADR>
</B721>
<B721><SNM>Kurys<FNM>Barbara E.
<ADR>
<STR>69 Fencsak Avenue
<CITY>Elmwood Park
<PCODE>NJ 07407
<CTRY>US
</ADR>
</B721>
</B720>
<B740>
<B741><SNM>Becker
<FNM>Heinrich Karl Engelbert<TTL>Dr.
<SFX>et al
<ADR>
<ONM>HOECHST AKTIENGESELLSCHAFT
<ODV>Central Patent Department
<PBOX>P.O. Box 80 03 20
<PCODE>W-6230
<CITY>Frankfurt am Main 80
<CTRY>DE
</ADR>
</B740>
</B700>
<B800>
<B840><CTRY>AT BE CH DE DK ES FR GB GR IT LI LU NL SE
</B800>
</SDOBI>
<SDOAB LA=EN>
<P>This invention relates to 4- and 6-carbamates related to physostigmine of the formula
<EMI ID="45.1" HE=48 WI=73 LX=759 LY=732 TI=CF>
<PC>where R<SB>1</SB> is alkyl, cycloalkyl, bicycloalkyl, aryl or arylloweralkyl; R<SB>2</SB>
is hydrogen or alkyl or the group -NR<SB>1</SB>R<SB>2</SB> taken together forms a monocyclic
or bicyclic ring of 5 to 12 carbons; m is 0, 1, or 2; each X is independently hydrogen, halogen,
loweralkyl, nitro or amino; and the pharmaceutically acceptable acid addition salts thereof, and where
applicable, the geometric and optical isomers and racemic mixtures thereof. This invention also relates to a
process and intermediates for the preparation of the 4- and 6-carbamates. The compounds of this invention
display utility for alleviating various memory dysfunctions characterized by a decreased cholinergic
function, such as Alzheimer's disease.
</SDOAB>

Appendix 5, page 31

<SDODE LA=EN>

<P>This invention relates to 4- and 6-carbamates related to physostigmine of the formula I

<EMI ID="1.1" HE=48 WI=88 LX=671 LY=671 TI=CF>

<PC>where R<SB>1</SB> is alkyl, cycloalkyl, bicycloalkyl, aryl or arylloweralkyl; R<SB>2</SB> is hydrogen or alkyl or the group -NR<SB>1</SB>R<SB>2</SB> taken together forms a monocyclic or bicyclic ring of 5 to 12 carbons; m is 0, 1 or 2; each X is independently hydrogen, halogen, loweralkyl, nitro or amino; and the pharmaceutically acceptable acid addition salts thereof, and where applicable, the geometric and optical isomers and racemic mixtures thereof. The compounds of this invention display utility in the treatment of the cholinergic deficit found in Alzheimer's disease.

<P>Preferred compounds of formula I above are compounds of formula Ia

<EMI ID="1.2" HE=34 WI=100 LX=650 LY=1802 TI=CF>

<PC>where R<SB>1</SB>, R<SB>2</SB> X and m are as previously defined.

<P>Also preferred compounds of formula I above are compounds of formula Ib below

<EMI ID="2.1" HE=52 WI=97 LX=562 LY=274 TI=CF>

<PC>where R<SB>1</SB>, R<SB>2</SB>, X and m are as previously defined.

<P>This invention also relates to compounds of formula II

.....

Appendix 5, page 32

EXAMPLE 2: Component 1 - type = TXT:

PREFIX ITEMS

Physical record #1

Item No	Field name	Field length	Type	Content
0	Internal record length	4	Bin	x'4DF30000' =(d'19955')
1	Record length	5	Char	19951
2	Publication office	2	Char	EP
3	Kind of document	2	Char	A1
4	Document number	8	Char	0484573
5	Emperor's year code	1	Char	
6.1	Prefix character set (when ASCII)	1	Char	A
	(when EBCDIC)			E Blank
6.2	Length of variable data field (50)	5	Char	19699
6.3	Version number	2	Char	F2
7	Document component type	3	Char	TXT
8	Document component identification number	8	Char	00000001
9	Document component record sequence number	2	Bin	x'0001'
10	Date of issue of amendment	8	Char	
11	Others (exchange use)	15	Char	
12	Others (domestic use)	15	Char	
13	Originating office	2	Char	EP
14	Date of production	8	Char	19950621
15	Document status	1	Char	N
16	Document component status	1	Char	N
17	Highest frame number within page	4	Char	
18	Highest document record sequence number	4	Bin	x'00000005'
19	Highest document component record number sequence number	2	Bin	x'0001'
20	Distinction of revisory bulletin	1	Char	0
21	Size of document in height	3	Char	289
22	Size of document in width	3	Char	196
23.1	Document component record sequence number	4	Char	0001
23.2	Highest document record sequence number	6	Char	000005
23.3	Highest document component record sequence number	4	Char	0001
23.4	Others (exchange use)	1	Char	
24	Others (domestic use)	15	Char	
25	Data type	1	Char	T
26	Existence of bibliographic data	1	Char	
27	Existence of claim	1	Char	
28	Existence of drawing	1	Char	
29	Existence of amendment	1	Char	
30	Existence of description	1	Char	
31	Existence of abstract	1	Char	
32	Existence of search report	1	Char	
33	Existence of abstract drawing	1	Char	
34	Extended document number	15	Char	0484573 *)
35	Others (domestic use)	20	Char	
36	Compression method of image data	2	Char	

Appendix 5, page 33

Item No	Field name	Field length	Type	Content
37	K-Factor code	2	Char	
38	Resolution	2	Char	
39	Size of frame height	3	Char	
40	Size of frame width	3	Char	
41	Number of lines of frame height	4	Char	
42	Number of lines of frame width	4	Char	
43	Rotation Code	1	Char	
44	Frame location X-axis coordinates	4	Char	
45	Frame location Y-axis Coordinates	4	Char	
46	Fill order of bits in bytes	1	Char	
47	Others (exchange use)	20	Char	
48	Others (domestic use)	20	Char	
49	Length of variable data field	2	Bin	x'4CF3' (=d'19699')
50	Variable data field	V		<PATDOC> ... </PATDOC>

Note: For the text of this document four physical records are necessary but only the first one is shown in this example.

*) The number is right justified and extended with leading blanks.

Appendix 5, page 34

EXAMPLE 2: Component 2 - type = EMI:

IMAGE DATA

Note: for this patent there is no abstract drawing, the first image is an embedded image <EMI> within the abstract.



(12) **EUROPEAN PATENT APPLICATION**

(21) Application number: 90121267.0

(51) Int. Cl.⁵: C07D 487/04, C07D 209/34, A61K 31/40, //(C07D487/04, 209:00,209:00)

(22) Date of filing: 07.11.90

<p>The application is published incomplete as filed (Article 93 (2) EPC). The point in the description at which the omission obviously occurs has been left blank.</p> <p>(43) Date of publication of application: 13.05.92 Bulletin 92/20</p> <p>(94) Designated Contracting States: AT BE CH DE DK ES FR GB GR IT LI LU NL SE</p> <p>(71) Applicant: HOECHST-ROUSSEL PHARMACEUTICALS INCORPORATED Route 202-206 North Somerville New Jersey 08876(US)</p>	<p>(72) Inventor: Glamkowski, Edward J. 7 Owens Drive Warren, NJ 07060(US) Inventor: Kurys, Barbara E. 69 Fencsak Avenue Elmwood Park, NJ 07407(US)</p> <p>(74) Representative: Becker, Heinrich Karl Engelbert, Dr. et al HOECHST AKTIENGESELLSCHAFT Central Patent Department P.O. Box 80 03 20 W-6230 Frankfurt am Main 80(DE)</p>
---	---

(54) 4- and 6-Carbamates related to physostigmine, a process and intermediates for their preparation and their use as medicaments.

(57) This invention relates to 4- and 6-carbamates related to physostigmine of the formula

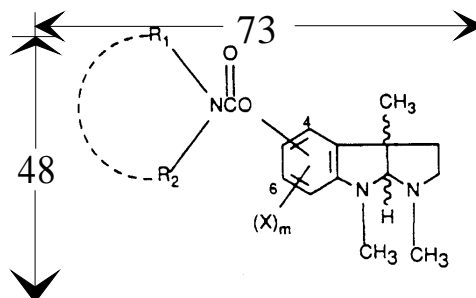

where R₁ is alkyl, cycloalkyl, bicycloalkyl, aryl or arylloweralkyl; R₂ is hydrogen or alkyl or the group -NR; R₂ taken together forms a monocyclic or bicyclic ring of 5 to 12 carbons; m is 0, 1, or 2; each X is independently hydrogen, halogen, loweralkyl, nitro or amino; and the pharmaceutically acceptable acid addition salts thereof, and where applicable, the geometric and optical isomers and racemic mixtures thereof. This invention also relates to a process and intermediates for the preparation of the 4- and 6-carbamates. The compounds of this invention display utility for alleviating various memory dysfunctions characterized by a decreased cholinergic function, such as Alzheimer's disease.

EP 0 484 573 A1

Appendix 5, page 35

EXAMPLE 2: Component 2 - type = EMI:

PREFIX ITEMS

Physical record #2

Item No	Field name	Field length	Type	Content
0	Internal record length	4	Bin	x'08B90000' (=d'2233')
1	Record length	5	Char	02229
2	Publication office	2	Char	EP
3	Kind of document	2	Char	A1
4	Document number	8	Char	0484573
5	Emperor's year code	1	Char	
6.1	Prefix character set (when ASCII)	1	Char	A
	(when EBCDIC)			E Blank
6.2	Length of variable data field (50)	5	Char	01977
6.3	Version number	2	Char	F2
7	Document component type	3	Char	EMI
8	Document component identification number	8	Char	00450001
9	Document component record sequence number	2	Bin	x'0001'
10	Date of issue of amendment	8	Char	
11	Others (exchange use)	15	Char	
12	Others (domestic use)	15	Char	
13	Originating office	2	Char	EP
14	Date of production	8	Char	19950621
15	Document status	1	Char	N
16	Document component status	1	Char	N
17	Highest frame number within page	4	Char	0001
18	Highest document record sequence number	4	Bin	x'00000005'
19	Highest document component record sequence number	2	Bin	x'0001'
20	Distinction of revisory bulletin	1	Char	0
21	Size of document in height	3	Char	297
22	Size of document in width	3	Char	210
23.1	Document component record sequence number	4	Char	0001
23.2	Highest document record sequence number	6	Char	000005
23.3	Highest document component record sequence number	4	Char	0001
23.4	Others (exchange use)	1	Char	
24	Others (domestic use)	15	Char	
25	Data type	1	Char	4
26	Existence of bibliographic data	1	Char	0
27	Existence of claim	1	Char	0
28	Existence of drawing	1	Char	0
29	Existence of amendment	1	Char	0
30	Existence of description	1	Char	0
31	Existence of abstract	1	Char	1
32	Existence of search report	1	Char	0
33	Existence of abstract drawing	1	Char	0
34	Others (exchange use)	15	Char	
35	Others (domestic use)	20	Char	
36	Compression method of image data	2	Char	M2
37	K-Factor code	2	Char	99

Appendix 5, page 36

Item No	Field name	Field length	Type	Content
38	Resolution	2	Char	12
39	Size of frame height	3	Char	048
40	Size of frame width	3	Char	073
41	Number of lines of frame height	4	Char	0567
42	Number of lines of frame width	4	Char	0864
43	Rotation Code	1	Char	1
44	Frame location X-axis coordinates	4	Char	0759
45	Frame location Y-axis Coordinates	4	Char	0732
46	Fill order of bits in bytes	1	Char	M
47	Others (exchange use)	20	Char	
48	Others (domestic use)	20	Char	
49	Length of variable data field	2	Bin	x'07B9' (=d'1977')
50	Variable data field	V		Image data

*) The number is right justified and extended with leading blanks.

Appendix 5, page 37

EXAMPLE 2: Components 3 to 5 - type = EMI:

IMAGE DATA

There are three embedded images within the page

EP 0 484 573 A1

This invention relates to 4- and 6-carbamates related to physostigmine of the formula I

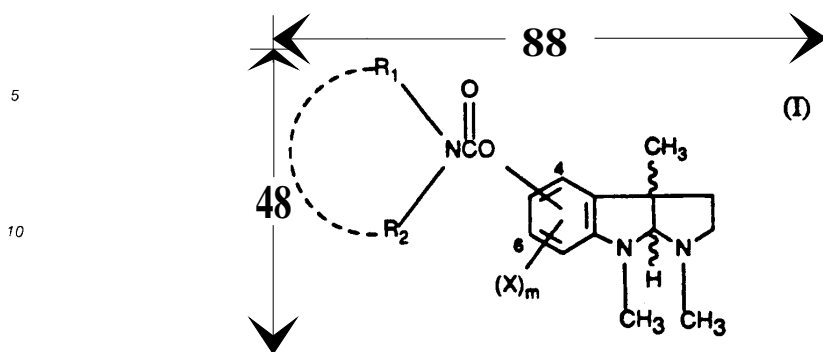

where R₁ is alkyl, cycloalkyl, bicycloalkyl, aryl or arylloweralkyl; R₂ is hydrogen or alkyl or the group -NR₁R₂ taken together forms a monocyclic or bicyclic ring of 5 to 12 carbons; m is 0, 1 or 2; each X is independently hydrogen, halogen, loweralkyl, nitro or amino; and the pharmaceutically acceptable acid addition salts thereof, and where applicable, the geometric and optical isomers and racemic mixtures thereof. The compounds of this invention display utility in the treatment of the cholinergic deficit found in Alzheimer's disease.

Preferred compounds of formula I above are compounds of formula Ia

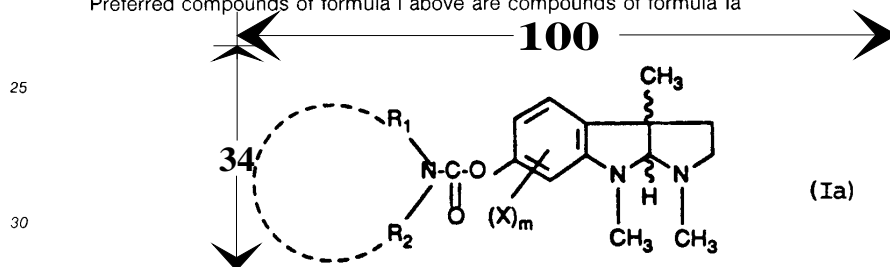

where R₁, R₂, X and m are as previously defined.

Also preferred compounds of formula I above are compounds of formula Ib below

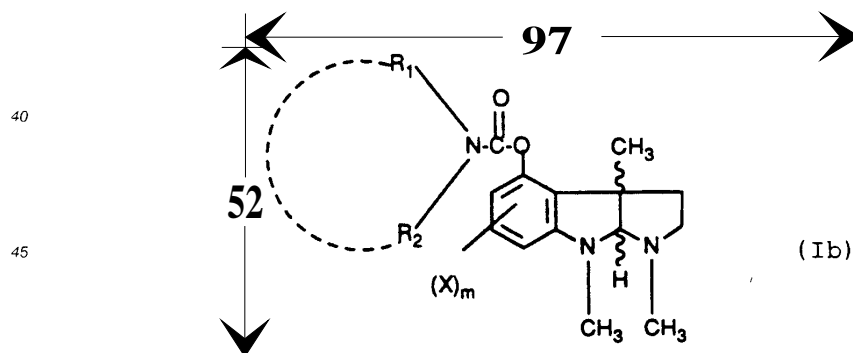

where R₁, R₂, X and m are as previously defined.

This invention also relates to compounds of formula II

Appendix 5, page 38

EXAMPLE 2: Component 3 - type = EMI:

PREFIX ITEMS

Physical record #3

Item No	Field name	Field length	Type	Content
0	Internal record length	4	Bin	x'08E70000' (=d'2279')
1	Record length	5	Char	02275
2	Publication office	2	Char	EP
3	Kind of document	2	Char	A1
4	Document number	8	Char	0484573
5	Emperor's year code	1	Char	
6.1	Prefix character set (when ASCII)	1	Char	A
	(when EBCDIC)			E Blank
6.2	Length of variable data field (50)	5	Char	02023
6.3	Version number	2	Char	F2
7	Document component type	3	Char	EMI
8	Document component identification number	8	Char	00010001
9	Document component record sequence number	2	Bin	x'0001'
10	Date of issue of amendment	8	Char	
11	Others (exchange use)	15	Char	
12	Others (domestic use)	15	Char	
13	Originating office	2	Char	EP
14	Date of production	8	Char	19950621
15	Document status	1	Char	N
16	Document component status	1	Char	N
17	Highest frame number within page	4	Char	0002
18	Highest document record sequence number	4	Bin	x'00000005'
19	Highest document component record sequence number	2	Bin	x'0001'
20	Distinction of revisory bulletin	1	Char	0
21	Size of document in height	3	Char	297
22	Size of document in width	3	Char	210
23.1	Document component record sequence number	4	Char	0001
23.2	Highest document record sequence number	6	Char	000005
23.3	Highest document component record sequence number	4	Char	0001
23.4	Others (exchange use)	1	Char	
24	Others (domestic use)	15	Char	
25	Data type	1	Char	4
26	Existence of bibliographic data	1	Char	0
27	Existence of claim	1	Char	0
28	Existence of drawing	1	Char	0
29	Existence of amendment	1	Char	0
30	Existence of description	1	Char	1
31	Existence of abstract	1	Char	0
32	Existence of search report	1	Char	0
33	Existence of abstract drawing	1	Char	0
34	Extended document number	15	Char	0484573 *)
35	Others (domestic use)	20	Char	
36	Compression method of image data	2	Char	M2
37	K-Factor code	2	Char	99

Appendix 5, page 39

Item No	Field name	Field length	Type	Content
38	Resolution	2	Char	12
39	Size of frame height	3	Char	048
40	Size of frame width	3	Char	088
41	Number of lines of frame height	4	Char	0567
42	Number of lines of frame width	4	Char	1056
43	Rotation Code	1	Char	1
44	Frame location X-axis coordinates	4	Char	0000
45	Frame location Y-axis Coordinates	4	Char	0000
46	Fill order of bits in bytes	1	Char	M
47	Others (exchange use)	20	Char	
48	Others (domestic use)	20	Char	
49	Length of variable data field	2	Bin	x'07E7' (=d'2023')
50	Variable data field	V		Image data

*) The number is right justified and extended with leading blanks.

Appendix 5, page 40

EXAMPLE 2: Component 4 - type = EMI:

PREFIX ITEMS

Physical record #4

Item No	Field name	Field length	Type	Content
0	Internal record length	4	Bin	x'08C30000' (=d'2243')
1	Record length	5	Char	02239
2	Publication office	2	Char	EP
3	Kind of document	2	Char	A1
4	Document number	8	Char	0484573
5	Emperor's year code	1	Char	
6.1	Prefix character set (when ASCII)	1	Char	A
	(when EBCDIC)			E Blank
6.2	Length of variable data field (50)	5	Char	01987
6.3	Version number	2	Char	F2
7	Document component type	3	Char	EMI
8	Document component identification number	8	Char	00010002
9	Document component record sequence number	2	Bin	x'0001'
10	Date of issue of amendment	8	Char	
11	Others (exchange use)	15	Char	
12	Others (domestic use)	15	Char	
13	Originating office	2	Char	EP
14	Date of production	8	Char	19950621
15	Document status	1	Char	N
16	Document component status	1	Char	N
17	Highest frame number within page	4	Char	0002
18	Highest document record sequence number	4	Bin	x'00000005'
19	Highest document component record sequence number	2	Bin	x'0001'
20	Distinction of revisory bulletin	1	Char	0
21	Size of document in height	3	Char	297
22	Size of document in width	3	Char	210
23	Document component record sequence number	4	Char	0001
23	Highest document record sequence number	6	Char	000005
23	Highest document component record sequence number	4	Char	0001
23	Others (exchange use)	1	Char	
24	Others (domestic use)	15	Char	
25	Data type	1	Char	4
26	Existence of bibliographic data	1	Char	0
27	Existence of claim	1	Char	0
28	Existence of drawing	1	Char	0
29	Existence of amendment	1	Char	0
30	Existence of description	1	Char	1
31	Existence of abstract	1	Char	0
32	Existence of search report	1	Char	0
33	Existence of abstract drawing	1	Char	0
34	Extended document number	15	Char	0484573 *)
35	Others (domestic use)	20	Char	
36	Compression method of image data	2	Char	M2
37	K-Factor code	2	Char	99

Appendix 5, page 41

Item No	Field name	Field length	Type	Content
38	Resolution	2	Char	12
39	Size of frame height	3	Char	034
40	Size of frame width	3	Char	100
41	Number of lines of frame height	4	Char	0402
42	Number of lines of frame width	4	Char	1184
43	Rotation Code	1	Char	1
44	Frame location X-axis coordinates	4	Char	0000
45	Frame location Y-axis Coordinates	4	Char	0000
46	Fill order of bits in bytes	1	Char	M
47	Others (exchange use)	20	Char	
48	Others (domestic use)	20	Char	
49	Length of variable data field	2	Bin	x'07C3' (=d'1987')
50	Variable data field	V		Image data

*) The number is right justified and extended with leading blanks.

Appendix 5, page 42

EXAMPLE 2: Component 5 - type = EMI:

PREFIX ITEMS

Physical record #5

Item No	Field name	Field length	Type	Content
0	Internal record length	4	Bin	x'094C0000' (=d'2380')
1	Record length	5	Char	02376
2	Publication office	2	Char	EP
3	Kind of document	2	Char	A1
4	Document number	8	Char	0484573
5	Emperor's year code	1	Char	
6.1	Prefix character set (when ASCII)	1	Char	A
	(when EBCDIC)			E Blank
6.2	Length of variable data field (50)	5	Char	02124
6.3	Version number	2	Char	F2
7	Document component type	3	Char	EMI
8	Document component identification number	8	Char	00020001
9	Document component record sequence number	2	Bin	x'0001'
10	Date of issue of amendment	8	Char	
11	Others (exchange use)	15	Char	
12	Others (domestic use)	15	Char	
13	Originating office	2	Char	EP
14	Date of production	8	Char	19950621
15	Document status	1	Char	N
16	Document component status	1	Char	N
17	Highest frame number within page	4	Char	0003
18	Highest document record sequence number	4	Bin	x'00000005'
19	Highest document component record sequence number	2	Bin	x'0001'
20	Distinction of revisory bulletin	1	Char	0
21	Size of document in height	3	Char	297
22	Size of document in width	3	Char	210
23	Document component record sequence number	4	Char	0001
23	Highest document record sequence number	6	Char	000005
23	Highest document component record sequence number	4	Char	0001
23	Others (exchange use)	1	Char	
24	Others (domestic use)	15	Char	
25	Data type	1	Char	4
26	Existence of bibliographic data	1	Char	0
27	Existence of claim	1	Char	0
28	Existence of drawing	1	Char	0
29	Existence of amendment	1	Char	0
30	Existence of description	1	Char	1
31	Existence of abstract	1	Char	0
32	Existence of search report	1	Char	0
33	Existence of abstract drawing	1	Char	0
34	Extended document number	15	Char	0484573 *)
35	Others (domestic use)	20	Char	
36	Compression method of image data	2	Char	M2

Appendix 5, page 43

Item No	Field name	Field length	Type	Content
37	K-Factor code	2	Char	99
38	Resolution	2	Char	12
39	Size of frame height	3	Char	052
40	Size of frame width	3	Char	097
41	Number of lines of frame height	4	Char	0614
42	Number of lines of frame width	4	Char	1152
43	Rotation Code	1	Char	1
44	Frame location X-axis coordinates	4	Char	0000
45	Frame location Y-axis Coordinates	4	Char	0000
46	Fill order of bits in bytes	1	Char	M
47	Others (exchange use)	20	Char	
48	Others (domestic use)	20	Char	
49	Length of variable data field	2	Bin	x'084C' (=d'2124')
50	Variable data field	V		Image data

*) The number is right justified and extended with leading blanks.

[End of Appendix 5 and of document]