

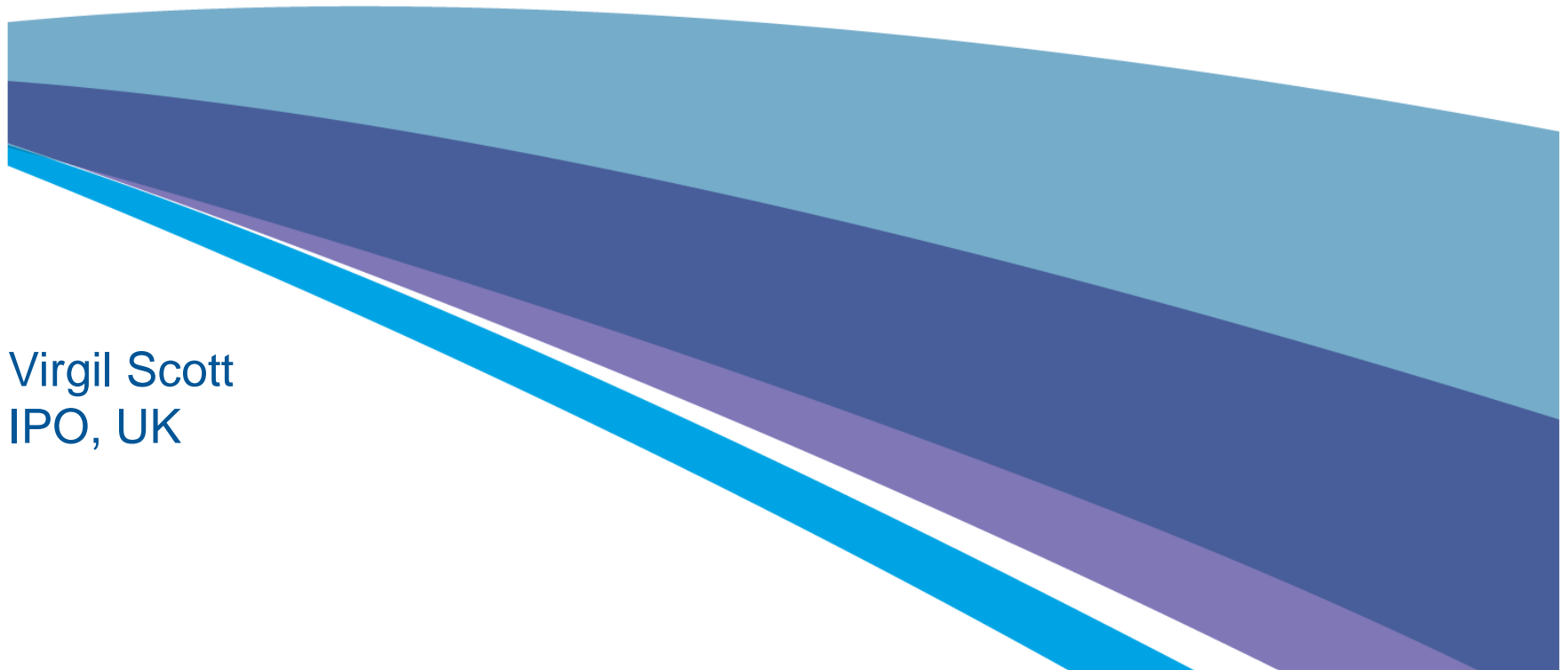

Intellectual
Property
Office

Inventive step



Virgil Scott
IPO, UK



The Patents Act 1977 - Section 1(1)

A patent may be granted only for an invention in respect of which the following conditions are satisfied, that is to say -

- (a) ...
- (b) it involves an **inventive step**;



The Patents Act 1977 - Section 3

an invention shall be taken to involve an inventive step if it is **not obvious** to a **person skilled in the art...**





Pozzoli Spa v BDMO SA & Anor [2007]
EWCA Civ 588

Windsurfing International Inc. v Tabur Marine
(Great Britain) Ltd, [1985] RPC 59 - The 4-
step test

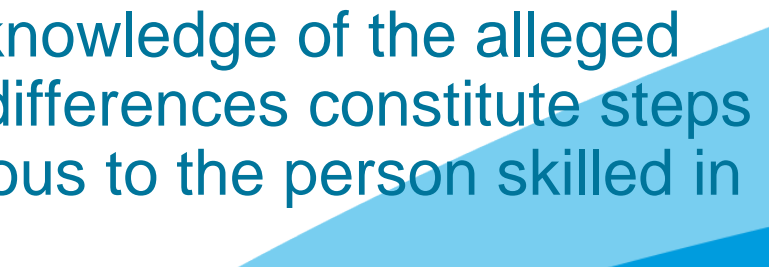

Pozzoli test for inventive step

- Step 1: Identify the person skilled in the art and their relevant common general knowledge (CGK)
 - Step 2: Identify the inventive concept of the claim in question or if that cannot readily be done, construe it
 - Step 3: Identify what, if any, differences exist between the matter cited as forming part of the “state of the art” and the inventive concept
 - Step 4: Viewed without any knowledge of the alleged invention claimed, do those differences constitute steps which would have been obvious to the person skilled in the art?
- 

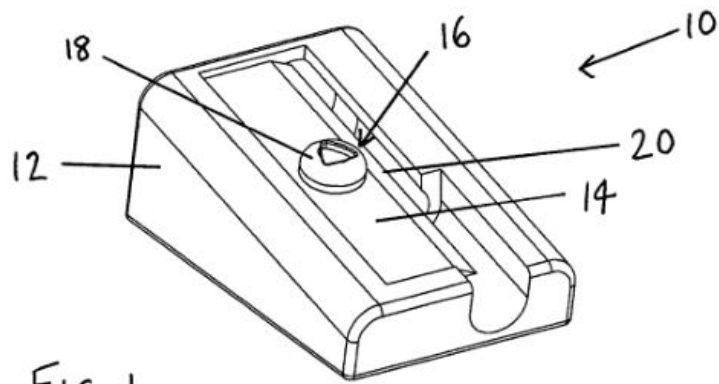

FIG. 1

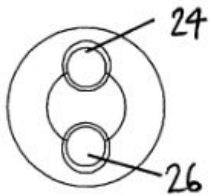

FIG. 2

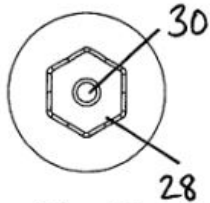

FIG. 3

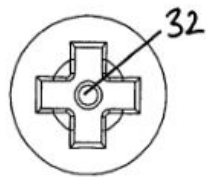

FIG. 4

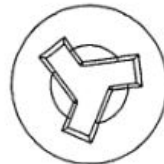

FIG. 5

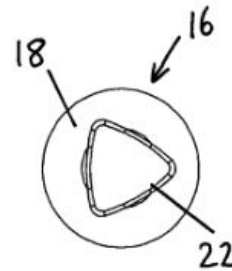

FIG. 6

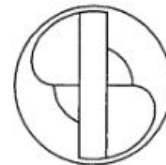
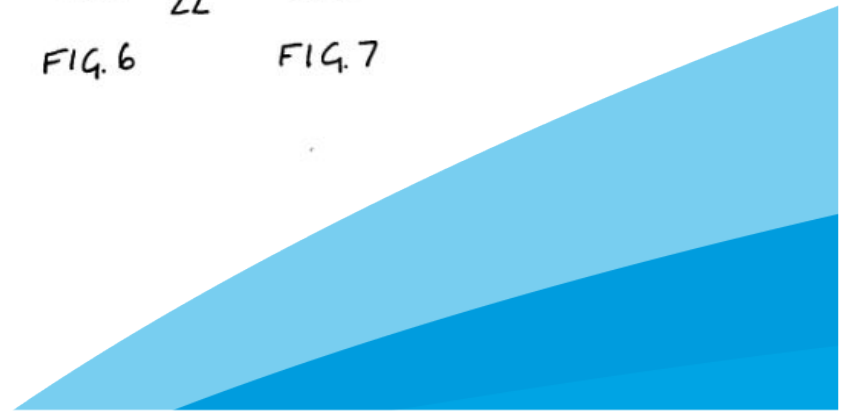

FIG. 7



Questions

