

WIPO SCIT Presentation - June 22 to 26, 1998

Patents via the Internet

**Distributed
Internet
Patent
Services**

Project Goals

- Basic Information
 - *Patent Awareness*
- Aimed at non patent professionals
- Information Dissemination
 - *via the national offices*
- Accessible worldwide
 - *via the internet*
- Free of charge to end user

Proposed Solution

- Two distinct levels
 - *Level 1: current awareness - national level*
 - *Level 2: global data availability*
- Access through National Offices
 - *Language customisation, patent helpdesk*
- Links
 - *With DG XIII , WIPO & Trilateral web-sites*

Level I - Requirements

- Distributed data
 - *Responsibility of National Office*
- 24 months minimum
 - *Bibliographic data*
 - *Full page (facsimile) images*
- “à la carte” extension

Level I - Solution

- Uniform solution
 - *Common to all National Offices*
- Standardised data management
 - *Storing and searching data*
- Forms based searching
 - *Simple to use*
 - *Local customisation*

Level I limitations

- Only patents from Europe
 - *Plus WO data*
- Limited coverage time-wise
 - *24 months basic coverage*
- Limited text searching
 - *Default : Titles (à la carte)*

WIPO SCIT Presentation - June 22 to 26, 1998

**National DIPS web-server
hosting national data acts
as access point for users**

WIPO SCIT Presentation - June 22 to 26, 1998

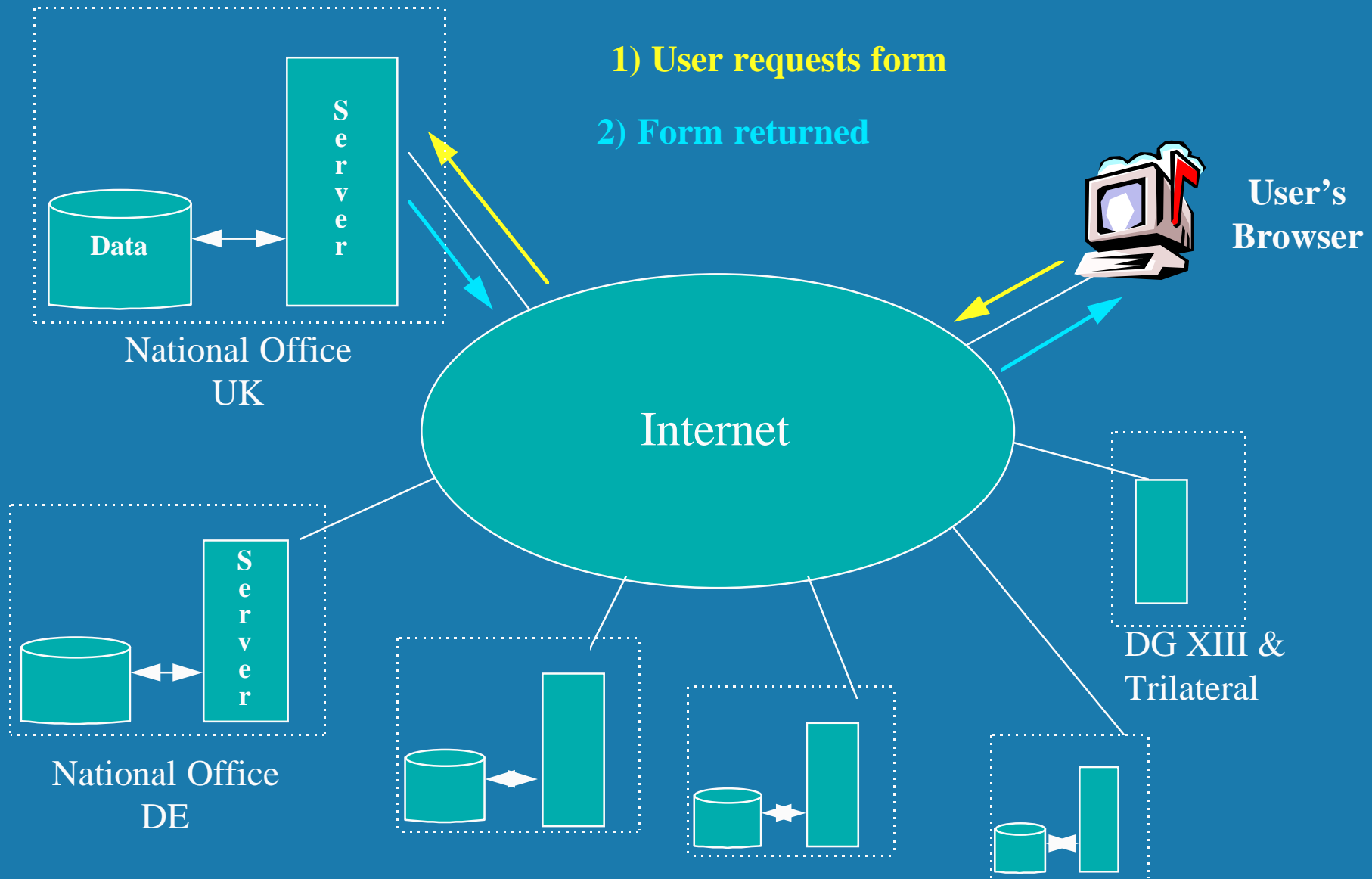

WIPO SCIT Presentation - June 22 to 26, 1998

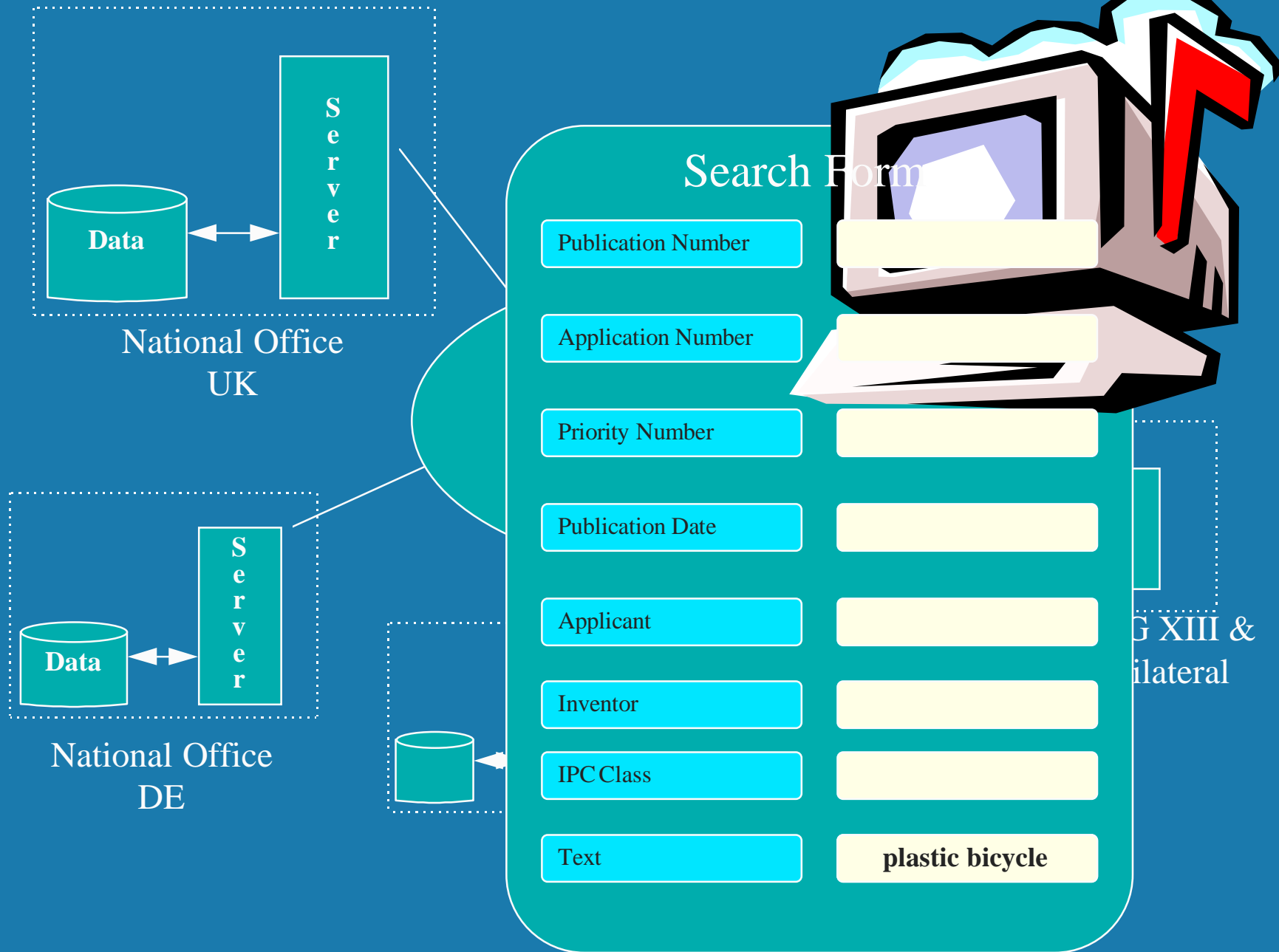

WIPO SCIT Presentation - June 22 to 26, 1998

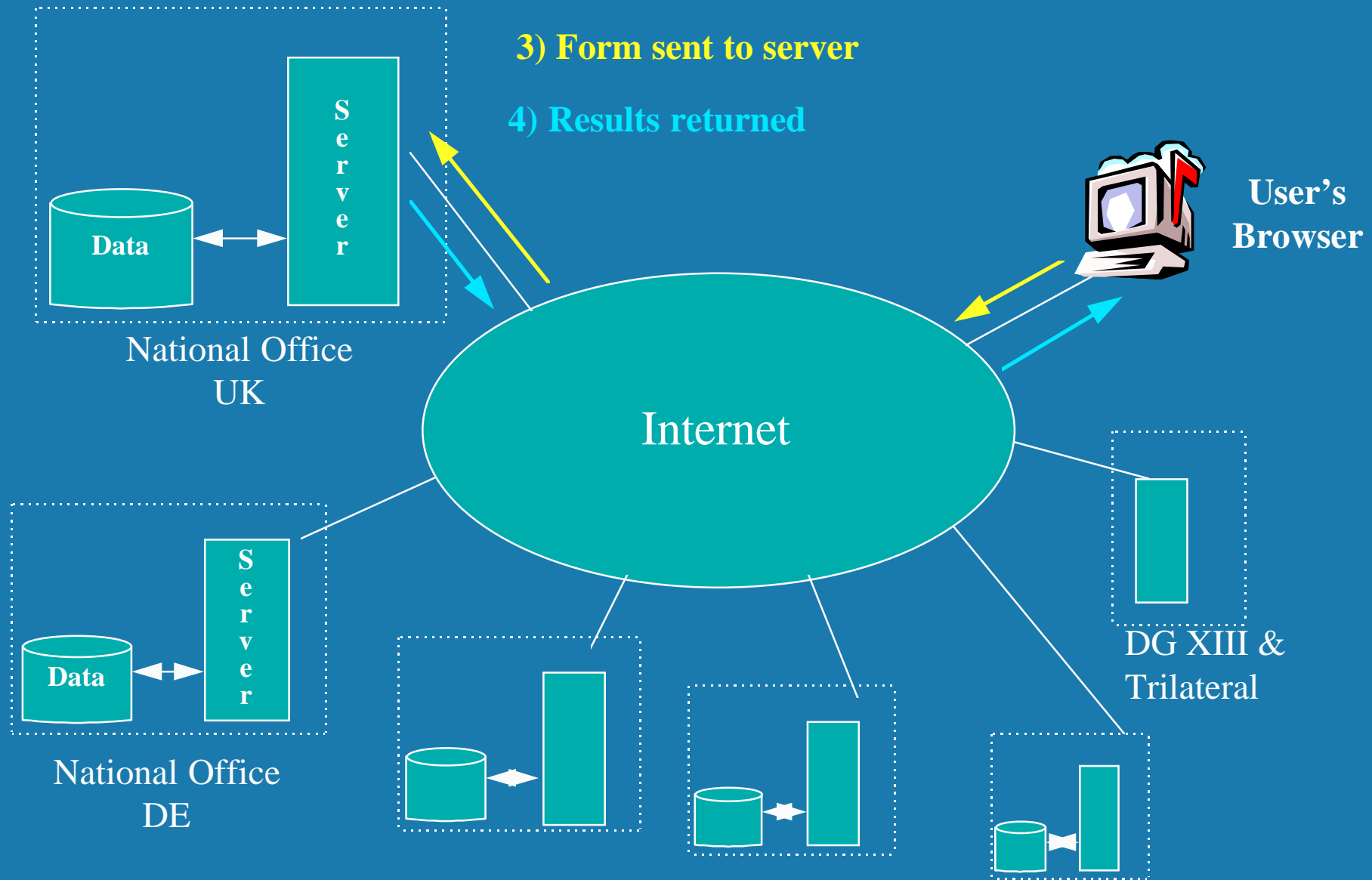

WIPO SCIT Presentation - June 22 to 26, 1998

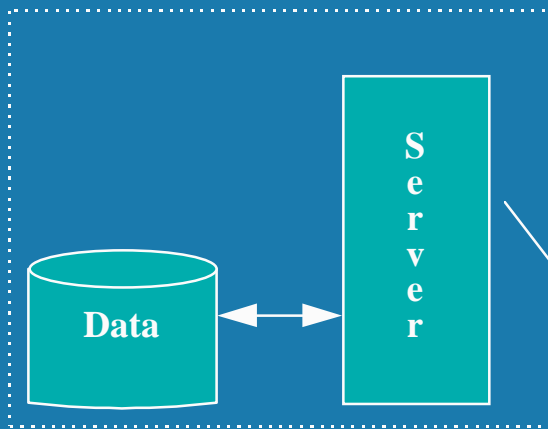

National Office
UK

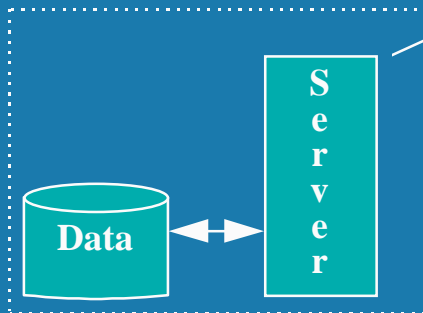

National Office
DE

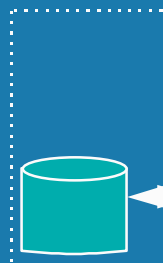

Search Results

- [GB2301325](#) Modular composite bicycle frame
- [GB2300841](#) Height adjustable resiliently mounted handle
- [GB2300392](#) Axle assembly for a bicycle
- [GB2299284](#) Manufacturing a bicycle axle unit
- [GB2299199](#) Noise generating bicycle attachment
- [GB2298964](#) Brushless wheel motor for a bicycle
- [GB2297826](#) A LAMP FOR A BICYCLE
- [GB2297528](#) Slidably adjustable front chainring axle of a bicycle
- [GB2296903](#) Bicycle connecting bar with breakable end connection
- [GB2296694](#) Bicycle front gear change and cog guard
- [GB2296224](#) Folding dismantlable bicycle with full size
- [GB2295868](#) Electrically controlled bicycle derailleur apparatus
- [GB2295427](#) Crank assembly for a bicycle in which ratio
- [GB2295005](#) BICYCLE INDICATOR LIGHT SET
- [GB2294753](#) A safety light for bicycle

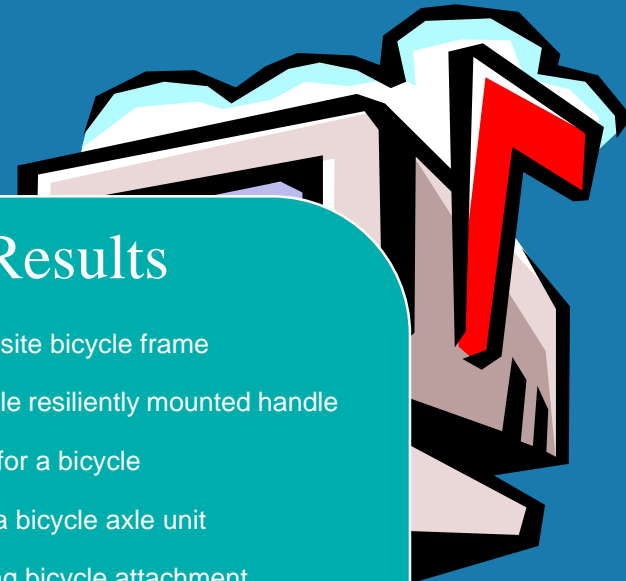

G XIII &
ilateral

“Cross” Searching

- Search data from another country
 - *Irrespective of access point*
- Use form from preferred Office
 - *Preference based on location / language*
- Select country to search
 - *Can search in any countries data*
- Perform search

WIPO SCIT Presentation - June 22 to 26, 1998

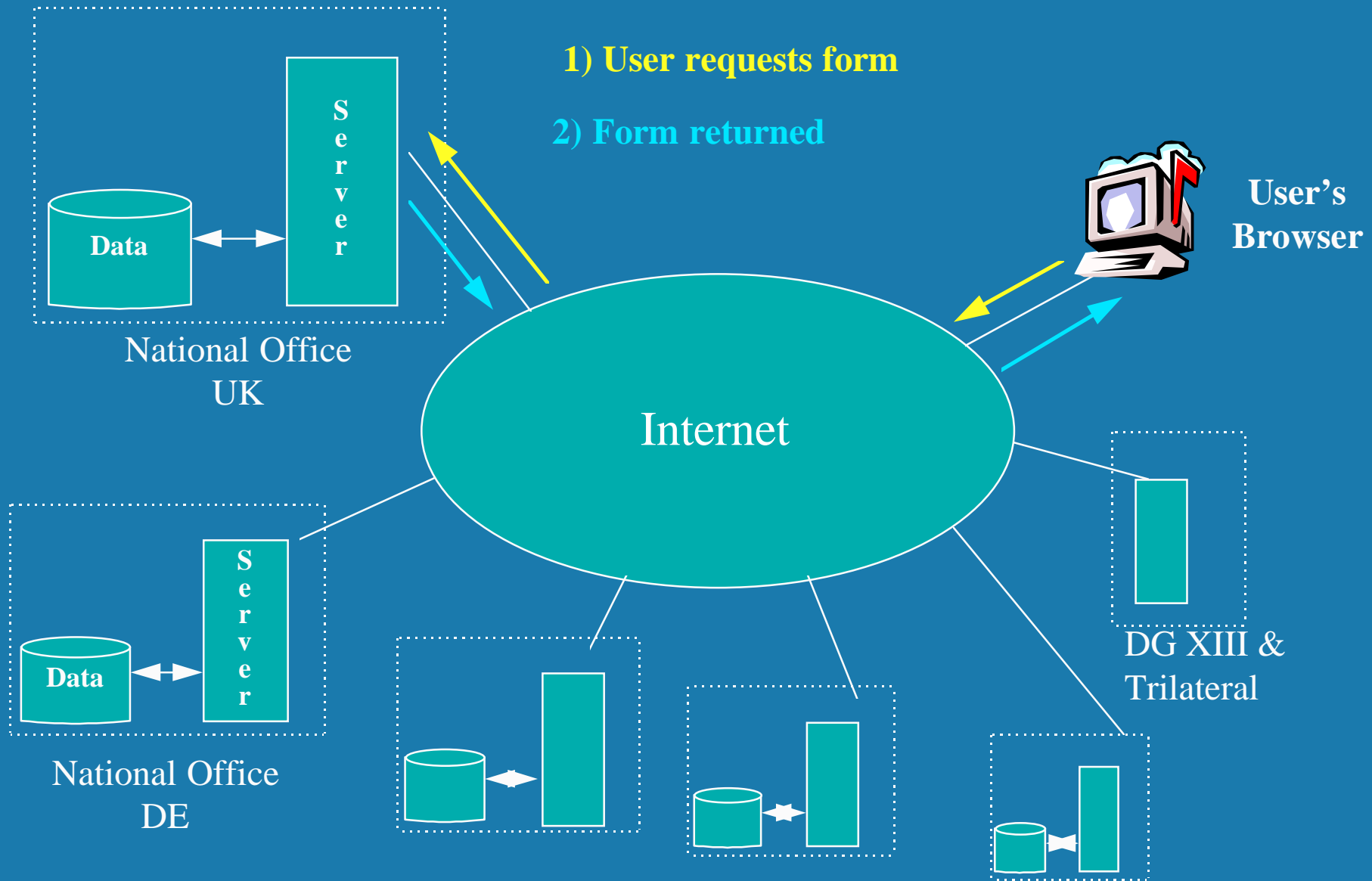

WIPO SCIT Presentation - June 22 to 26, 1998

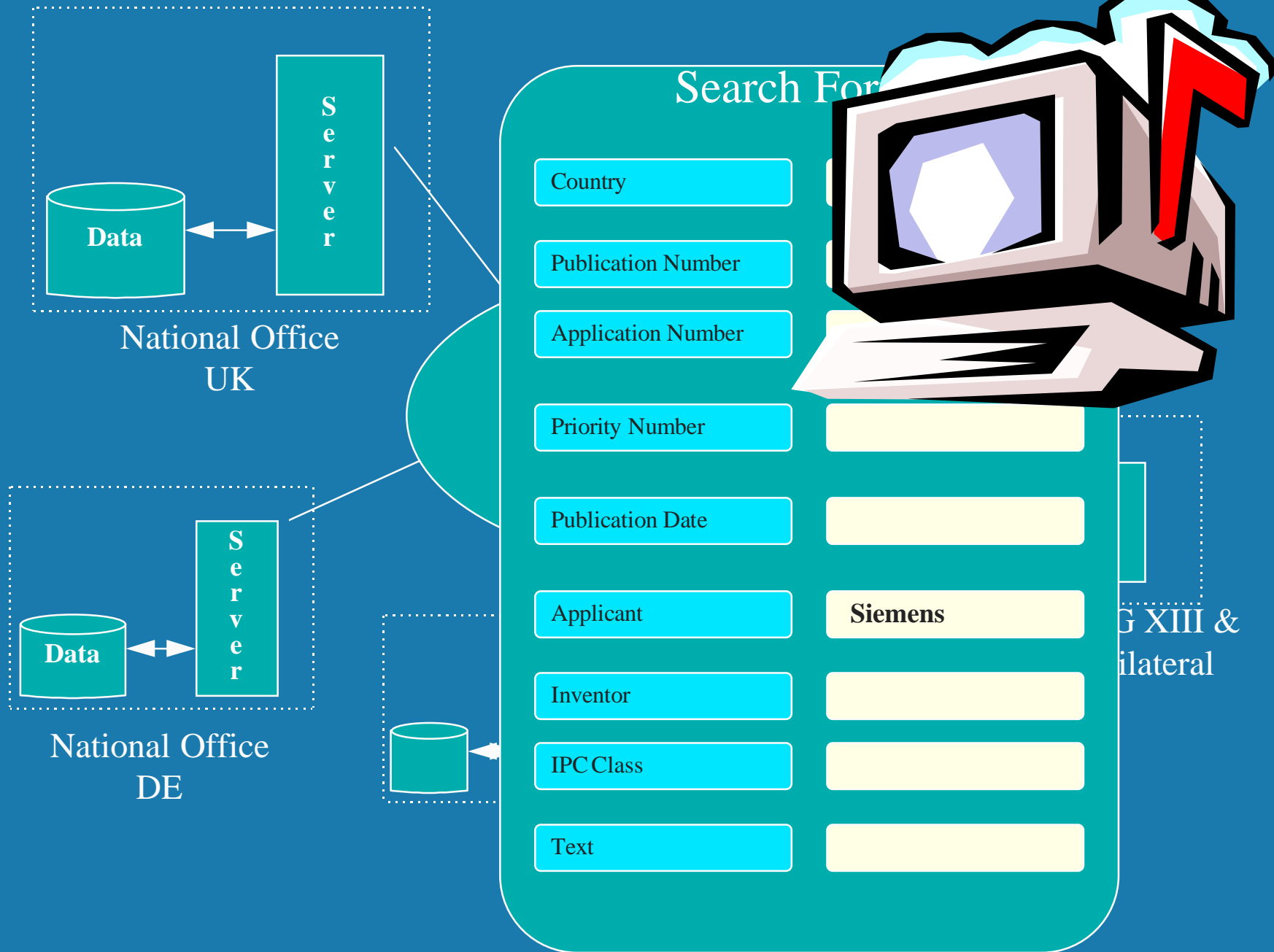

WIPO SCIT Presentation - June 22 to 26, 1998

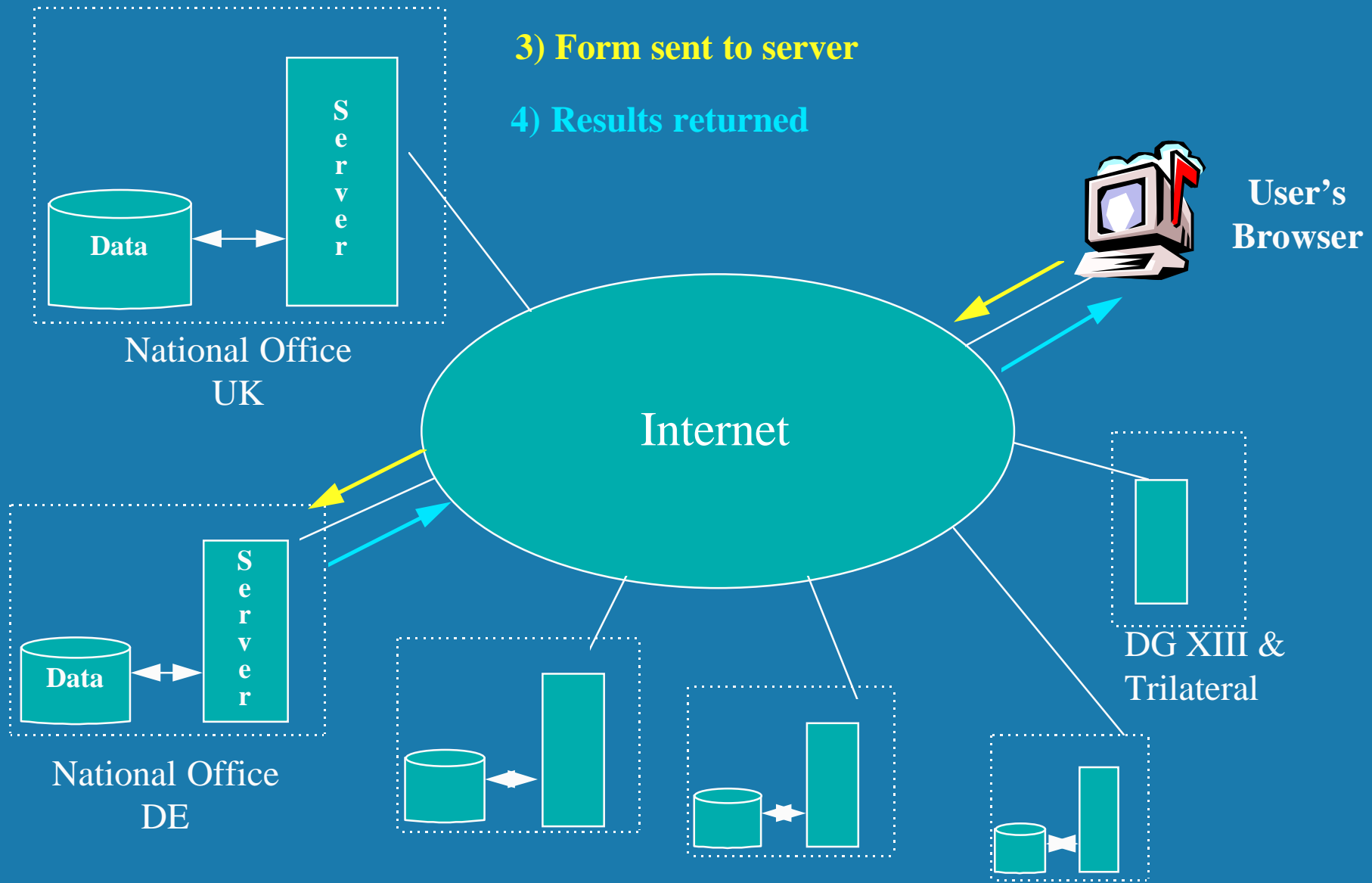

WIPO SCIT Presentation - June 22 to 26, 1998

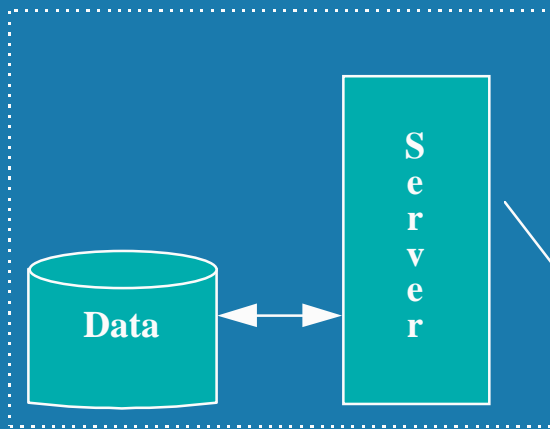

National Office
UK

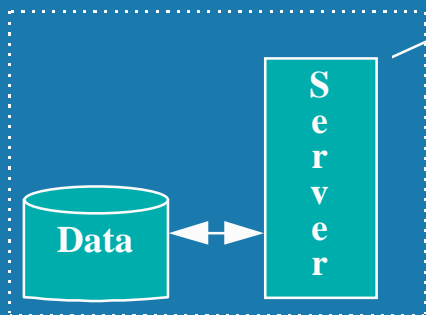

National Office
DE



Search Results

- [DE19608720](#) Analog-Digital-Wandler
- [DE19522585](#) Verfahren zum Verme...
- [DE19522584](#) Verfahren zur Behandlung...
- [DE19522582](#) Schaltungsanordnu...
- [DE19521716](#) Prozessrohr mit Endverschluss
- [DE19521714](#) Schneidklemm-Anschlusseinrichtung für Koaxialk ...
- [DE19521674](#) Biegekoppler und Verfahren zur Aus- und/oder ...
- [DE19521361](#) Elektrisches Schaltgerät
- [DE19521356](#) Gasturbine, umfassend einen Verdichterteil, einen ...
- [DE19521327](#) Verfahren und Codiereinrichtung zur gesicherten ...
- [DE19521308](#) Gasturbine zur Verbrennung eines Brenngases ...
- [DE19521214](#) Lagerkorb sowie Lagergestell zur kompakten Lager ...
- [DE19521001](#) Kommunikationsfähige Schaltgeräteeinheit ...
- [DE19520632](#) Verfahren und Anordnung zum Rufen eines ...
- [DE19519191](#) Einspritzventil
- [DE19517964](#) Vorrichtung zur Identifikation von prozessierbaren ...

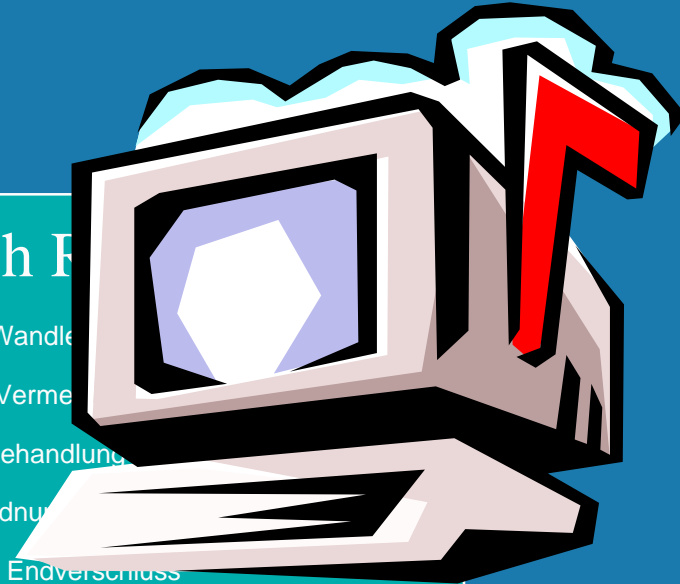

G XIII &
ilateral

Level II Phase I - Requirements

- Increased comprehensiveness
 - *Geographical and Chronological*
- Additional functionality
 - *Search and display of abstracts*
 - *Display of drawings and full text*
 - *Equivalent documents (family data)*
- Seamless with Level I

Level II Phase I - Solution

- Central storage of data
 - *Irrespective of country of origin*
- Access through National Offices
 - *Locally customised query forms*
- One representative per family
 - *Comprehensive coverage from 1970*
 - *Limited coverage back to 1920*
- Access to EPOQUE QS - “slim” engine
 - *Search titles, abstracts and bibliography*
 - *Display bib, abstract, full text and full doc.*

Level II Phase II - Requirements

- Online delivery of facsimile documents
 - *29 million documents from 1920 onwards*
- Access from level I or II
 - *Document Tagging (shopping basket)*
- Standalone access - no search required
- Delivery of complete documents

WIPO SCIT Presentation - June 22 to 26, 1998

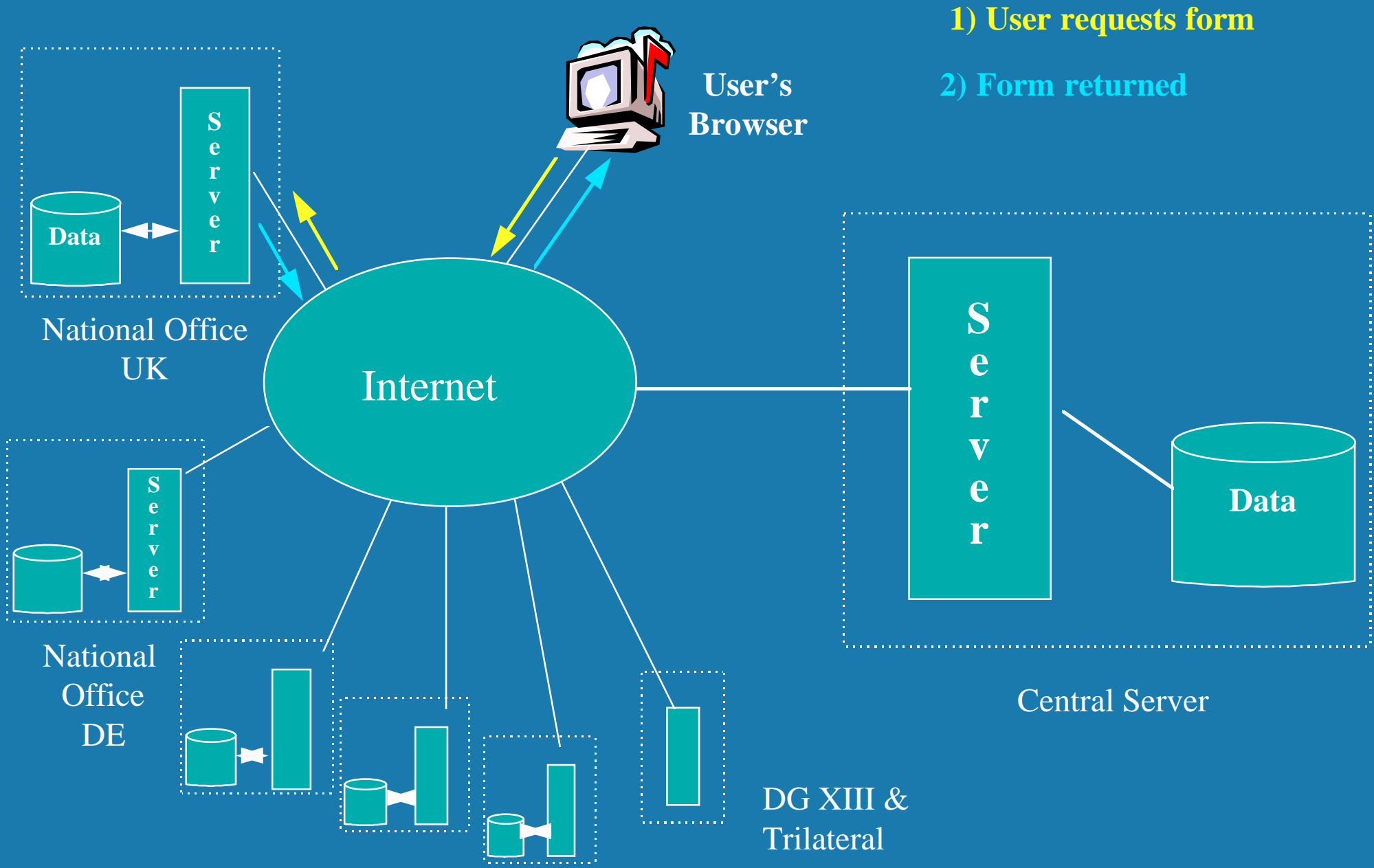

1) User requests form

2) Form returned

WIPO SCIT Presentation - June 22 to 26, 1998

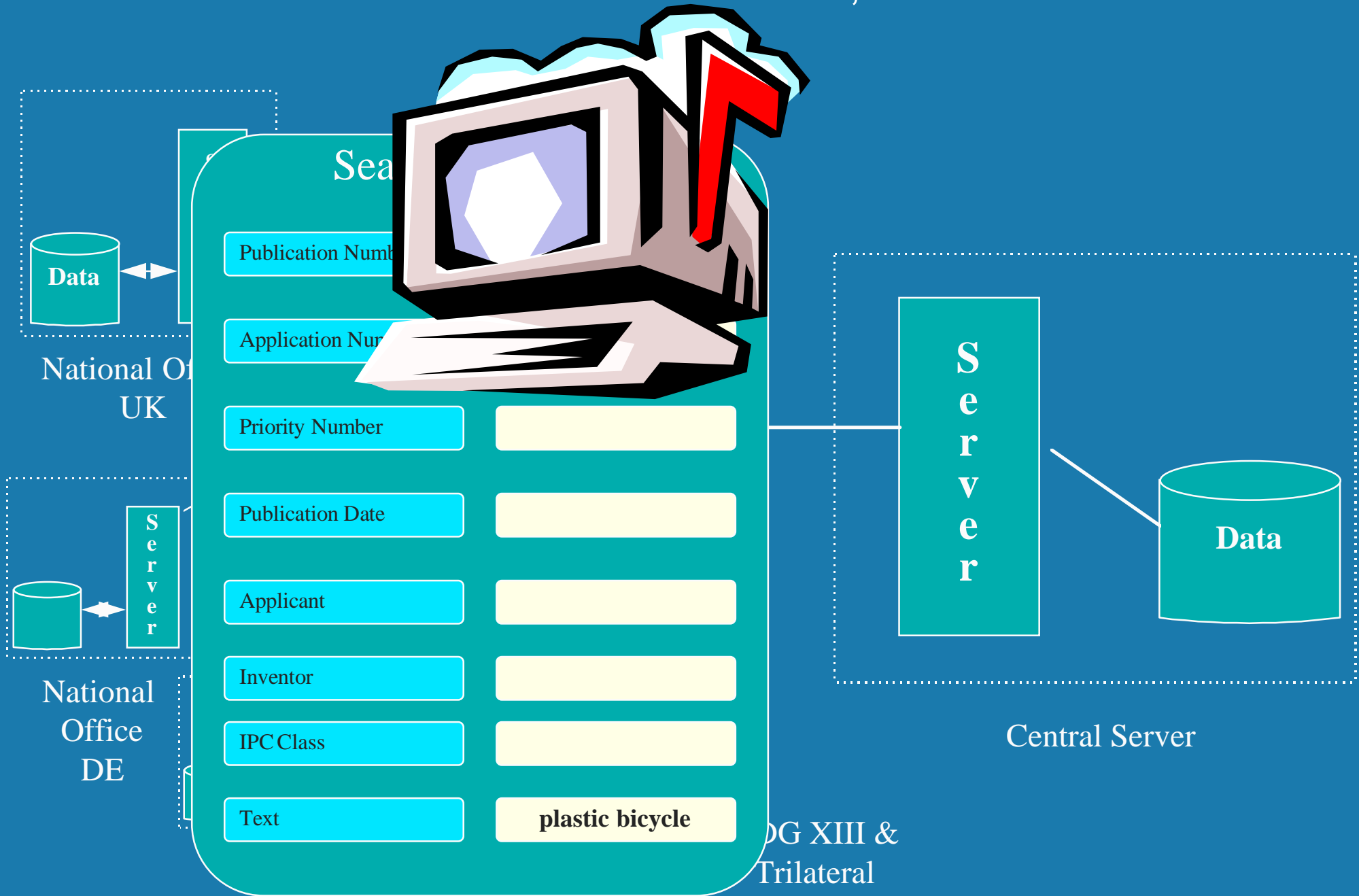

WIPO SCIT Presentation - June 22 to 26, 1998

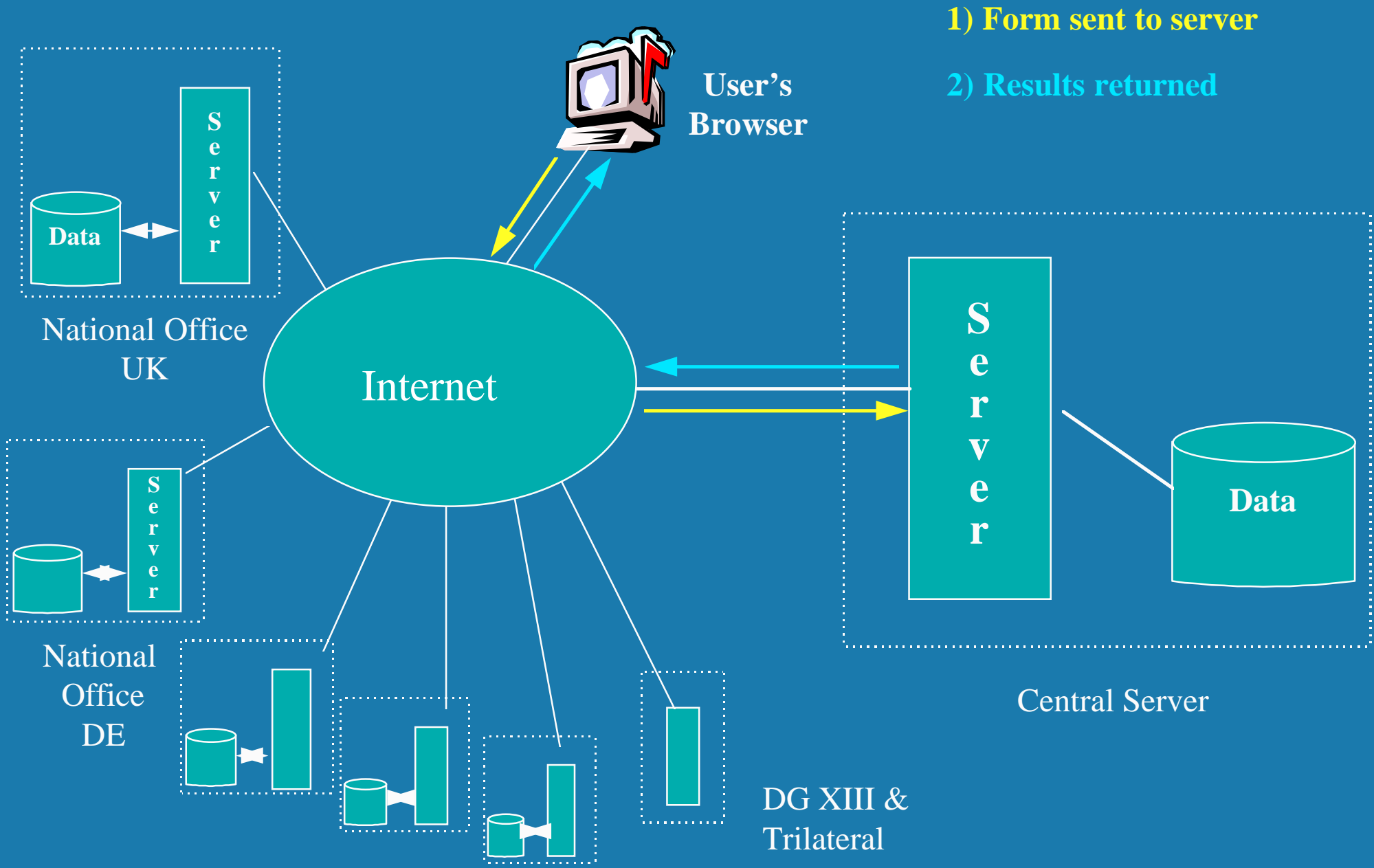

1) Form sent to server

2) Results returned

WIPO SCIT Presentation - June 22 to 26, 1998



Search Results

- GB2249596 A CHAIN THROWER MECHANISM COMPRISING...
- GB2248807 Composite plastic bicycle frame with tubes and connec ...
- FR2719807 Plastic wheel rim useful esp. for bicycle, cart ...
- FR2669291 Bicycle frame made of plastic composite with ...
- FR2648635 Dynamo structure for bicycle with a moulded plastic body
- WO9504666 INJECTION MOLDED PLASTIC BICYCLE ...
- WO9416911 INJECTION MOLDED PLASTIC BICYCLE...
- EP0712357 INJECTION MOLDED PLASTIC BICYCLE ...
- EP0680414 INJECTION MOLDED PLASTIC BICYCLE ...
- DE4437059 Apparatus for cutting and/or plastic deformation of ...
- DE4425592 Fibre reinforced plastic bicycle wheel, with special ...
- DE4328349 Dividable bicycle with a frame made from ligh ..
- DE4326667 Bicycle crash helmet made of plastic, and ...
- DE3812510 Bicycle manufactured from die-cast light ...
- DE3421210 Bicycle chain guard made of plastic

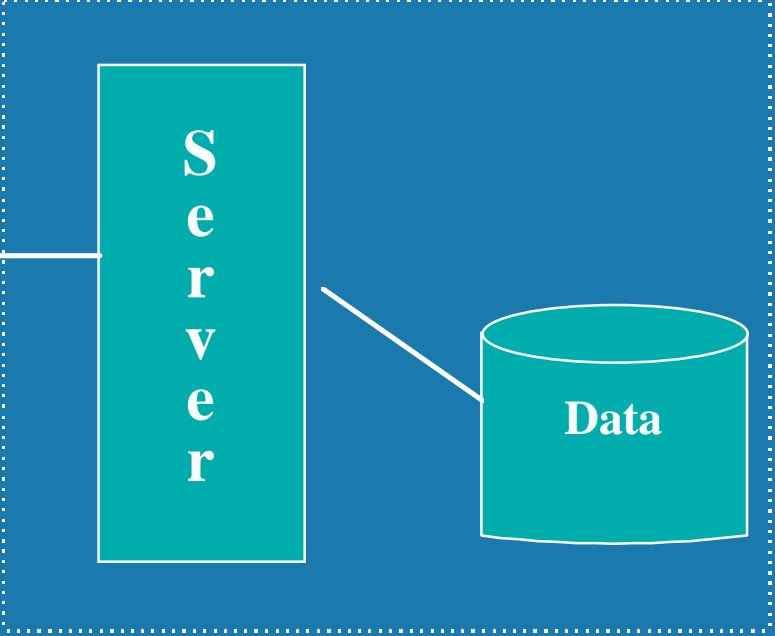
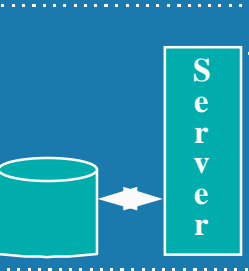
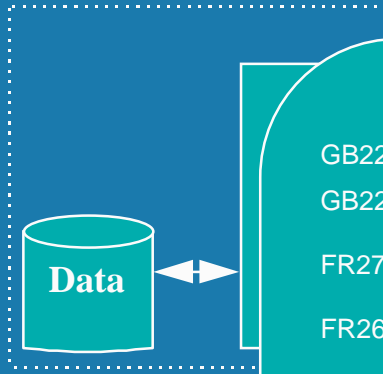

Central Server

National Office
UK

National
Office
DE

DG XIII &
Trilateral

WIPO SCIT Presentation - June 22 to 26, 1998

DEMONSTRATION

Level 1 Access