

Initiatives for Work Sharing (PPH)

Patent Prosecution Highway (PPH)

NAKANO Hiroyuki

Deputy Director
Examination Policy Planning Office,
Administrative Affairs Division
Japan Patent Office (JPO)





I. Scheme of the PPH



II. Benefits of the PPH



III. How to examine PPH applications



Patent Prosecution Highway (PPH)



OEE (Office of Earlier Examination)

Application A

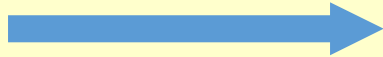

Grant

Claims correspondence



OLE (Office of Later Examination)



Corresponding Application A'



PPH Request

Accelerated Examination

Access to OEE Examination History



Work Sharing

OLE Examination workload is reduced

Advantage for Office

Advantage for Applicant



Increasing number of PPH Participating Offices

In 2006, JPO proposed the PPH for the first time.
In 2019, 50 offices participate in the PPH.

Number of PPH Participating Offices

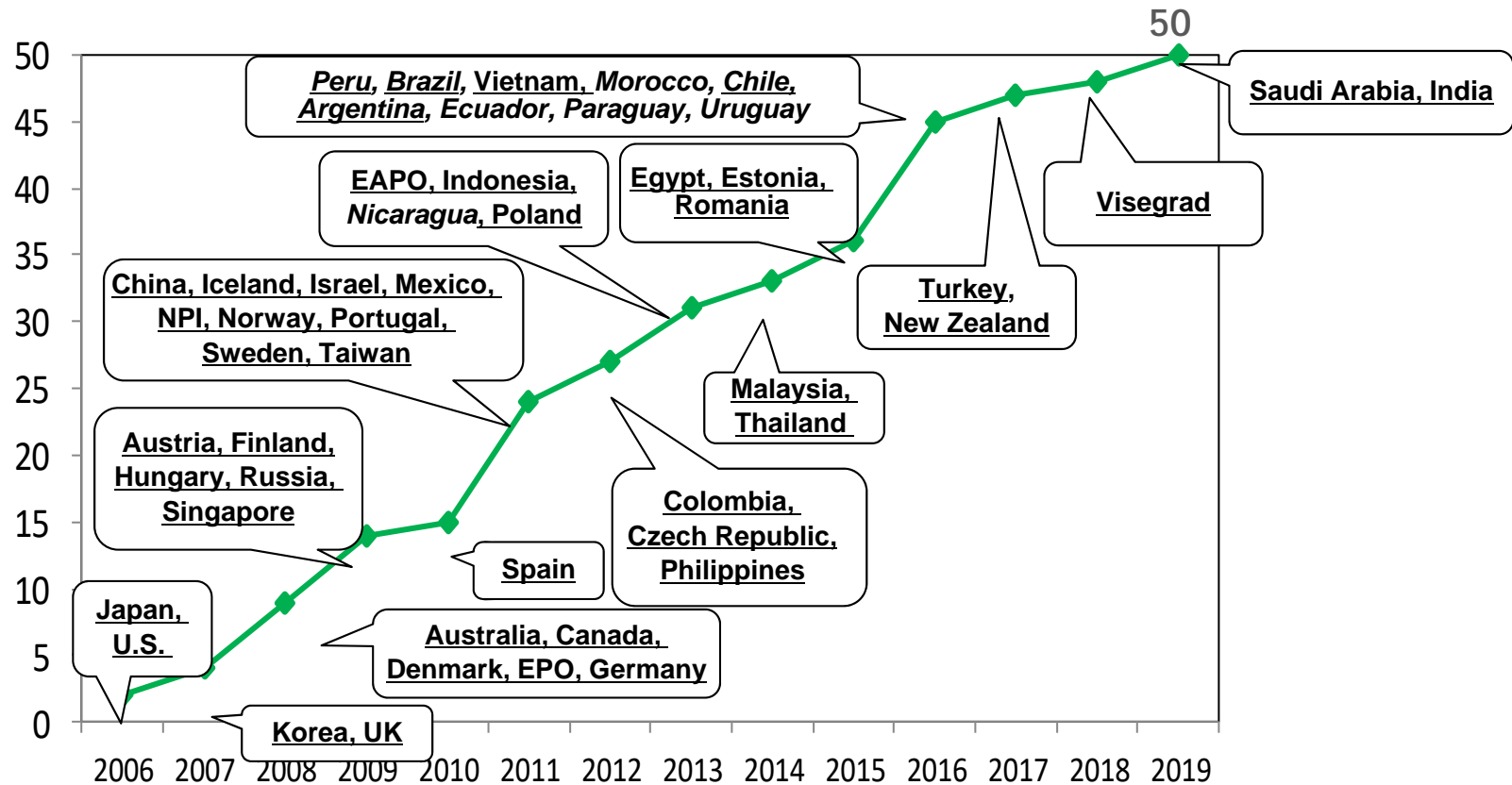

Note: JPO has PPH partnership with underlined 44 offices



Number of applications examined in PPH

Number of applications examined in PPH in the world

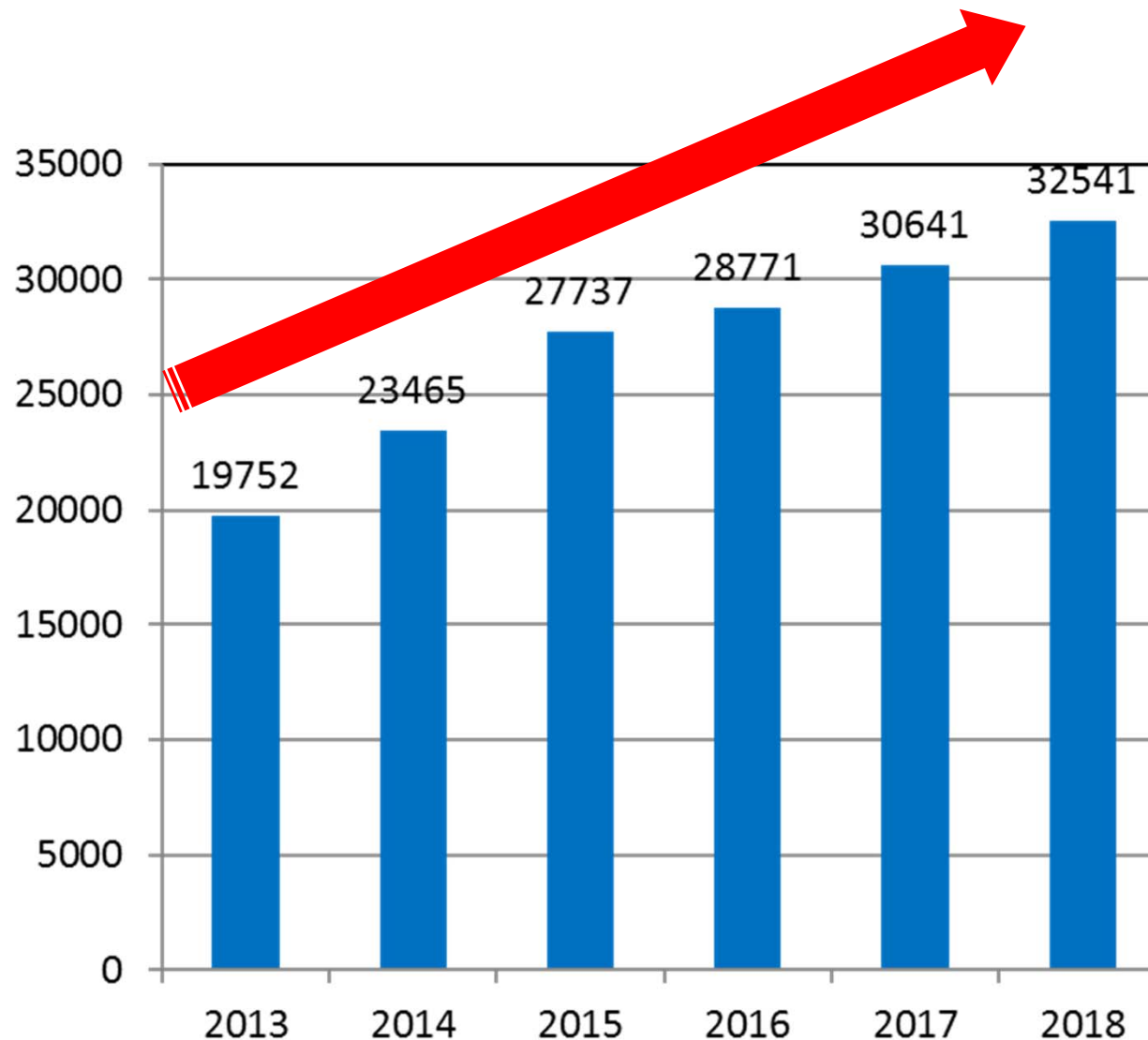



Development of scheme : PCT-PPH

The PCT based on a PCT international work product

International Phase

National/Regional Phase

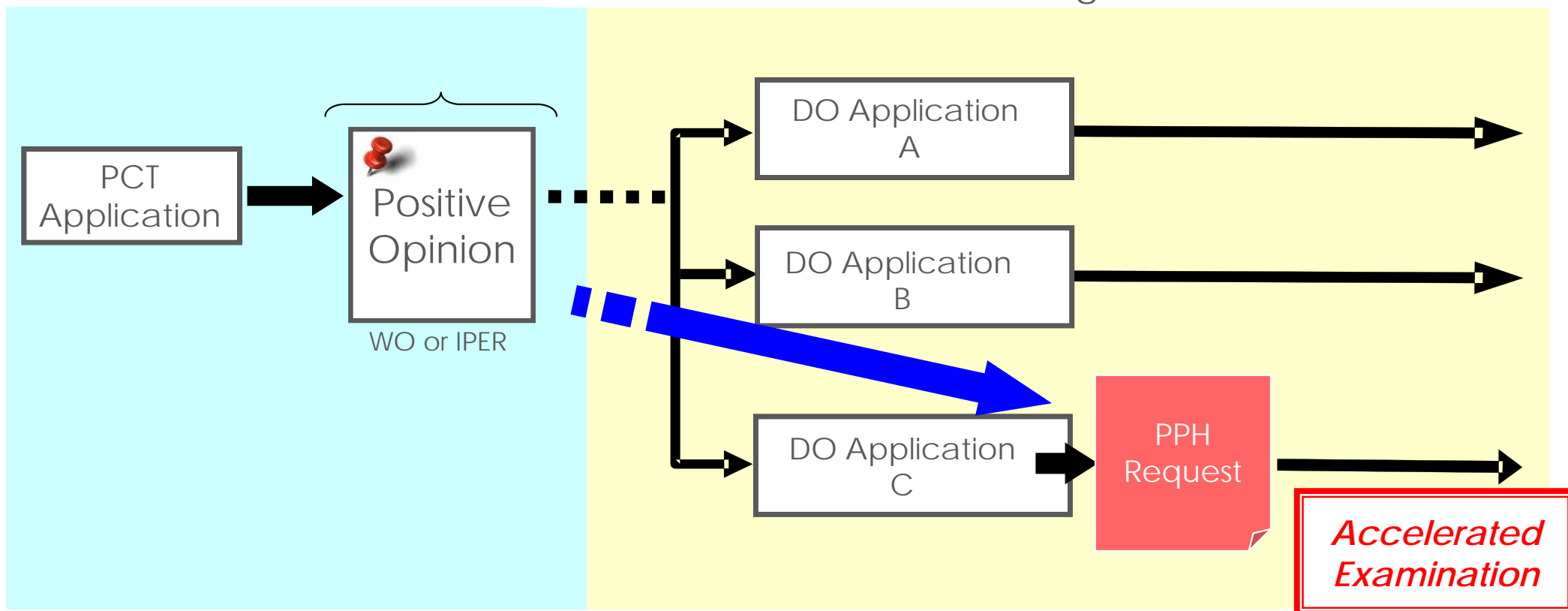



Development of scheme : Global PPH (GPPH)

Standardize the PPH schemes

Before launching Global PPH

17 offices at the start of Global PPH

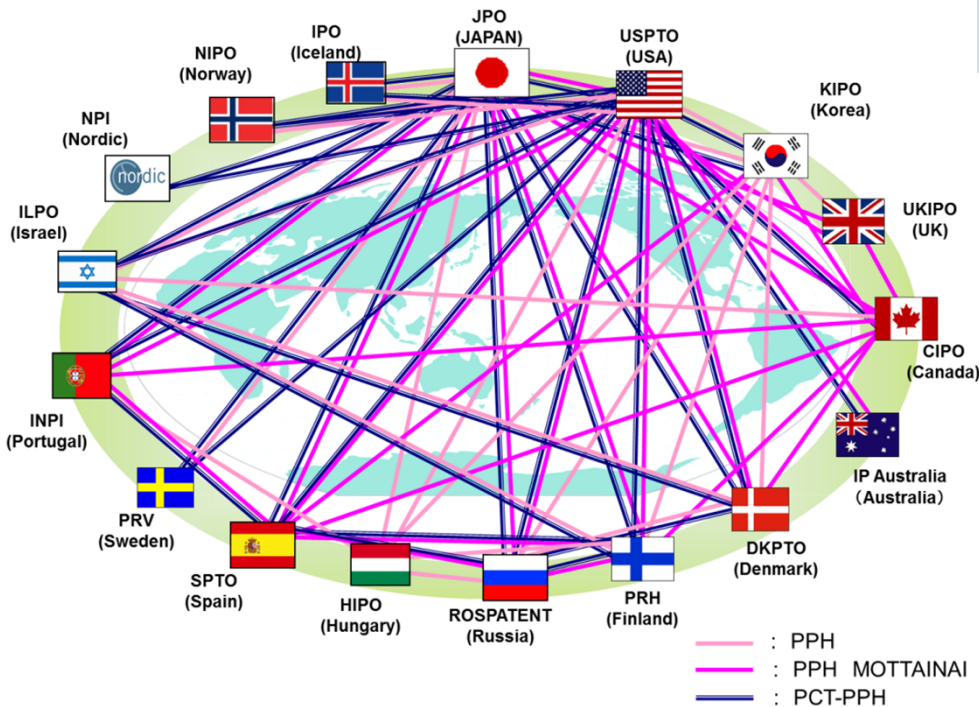

Global PPH

(From January 6, 2014)

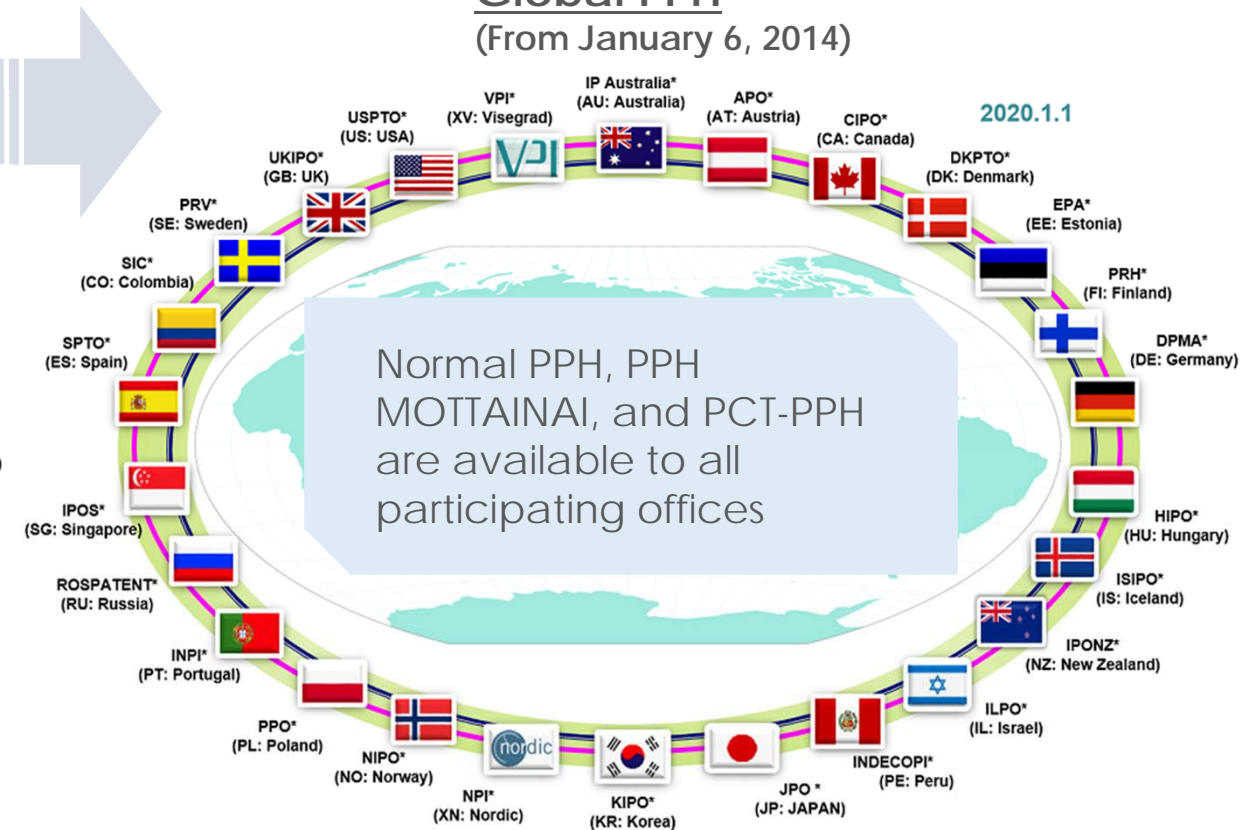



I. Scheme of the PPH



II. Benefits of the PPH



III. How to examine PPH applications



Benefits of the PPH in number

1. High Speed (Reduced Examination Period)
2. High Predictability (High Grant Rate)
3. Low Cost (High Grant Rate at FA : reduced procedure)

Pendency to First Action

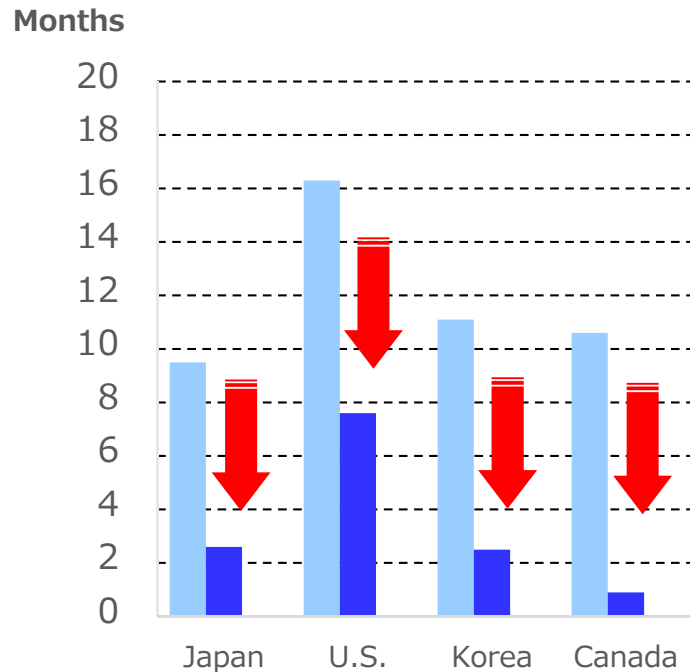

Grant rate

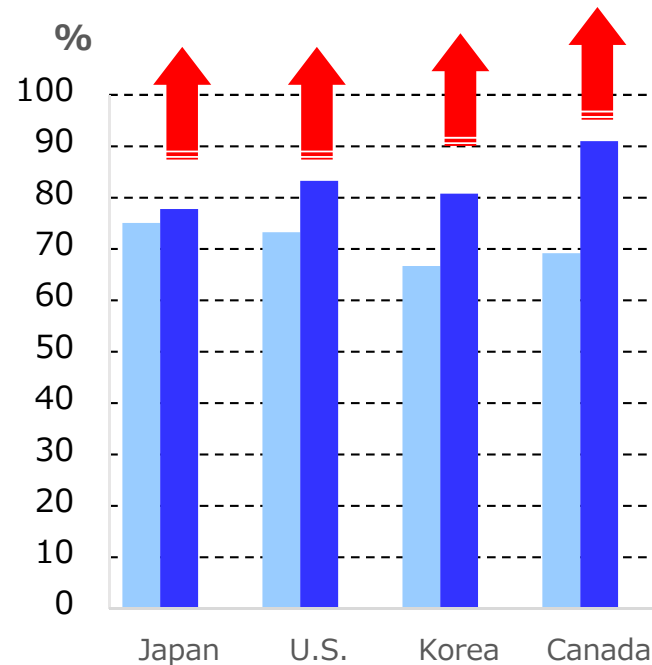

Grant rate at FA

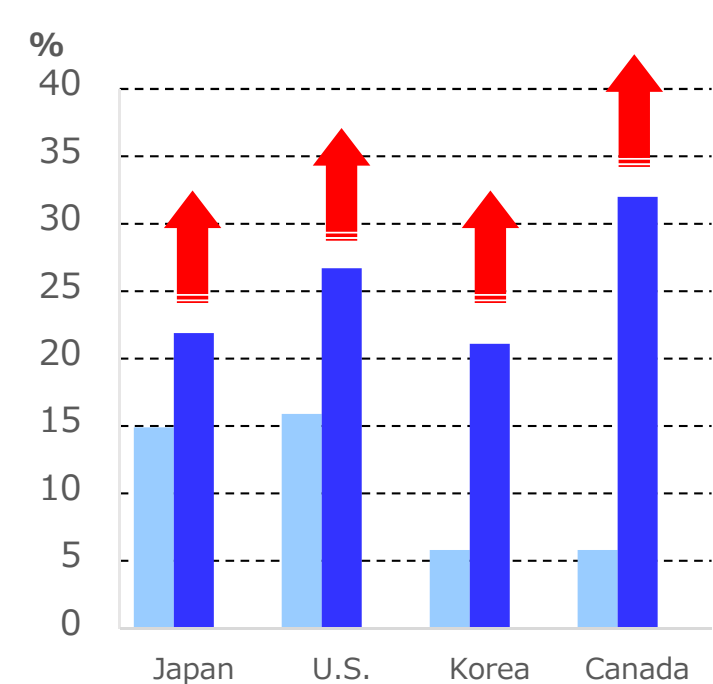

■ All applications ■ PPH applications (Jan. 2019 – Jun. 2019)



Improved efficiency thanks to work-sharing

Normal Case

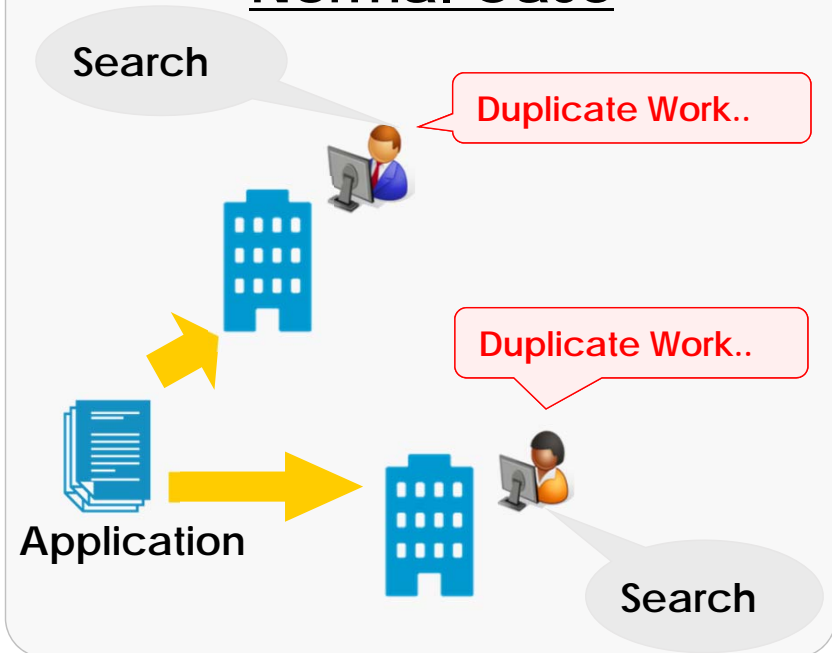

Work-sharing Case

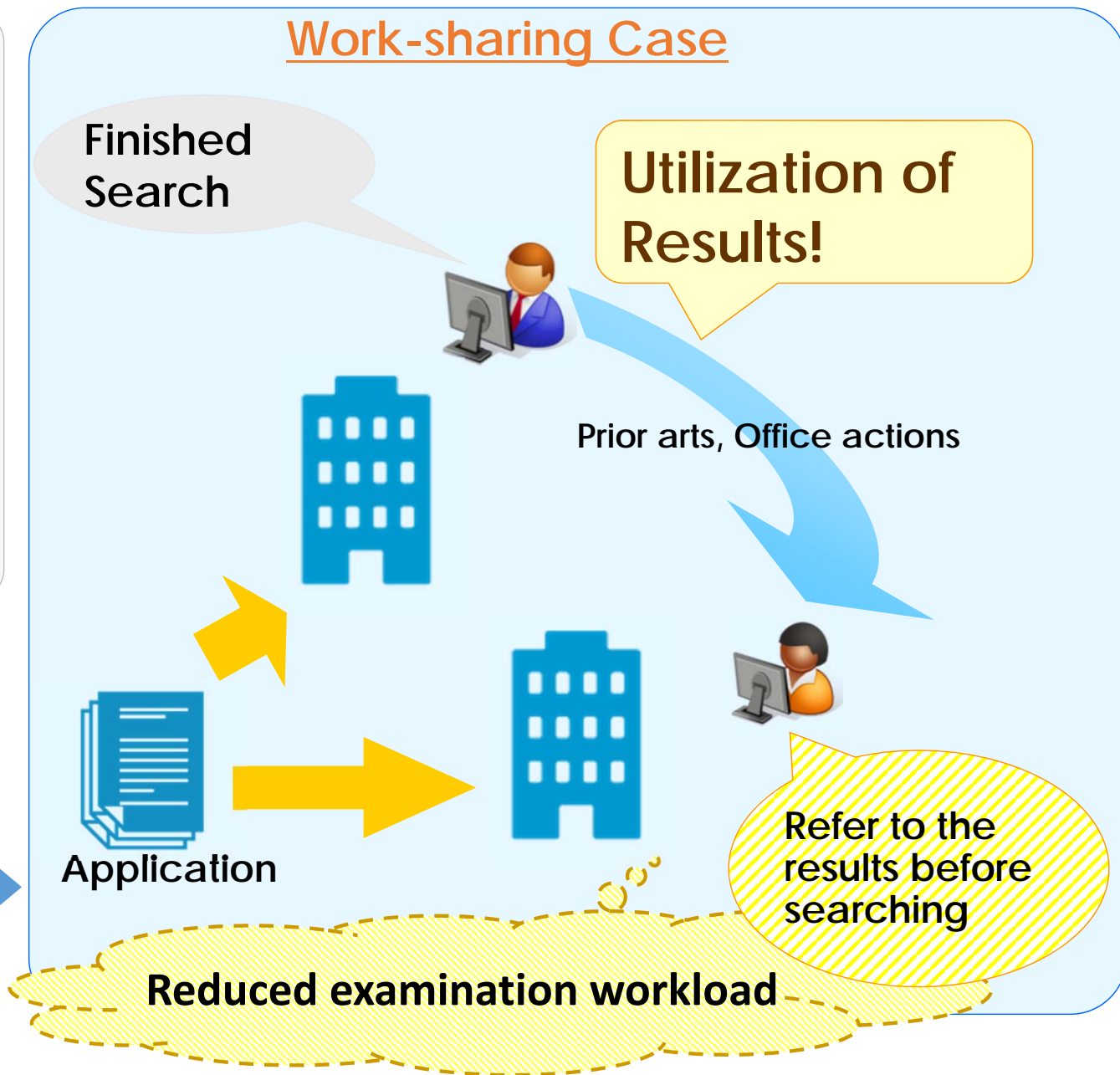



Reduce the examination workload

- A. Optimized claim scope
- B. Utilization of OEE examination history
- C. Reduction of the number of Office actions

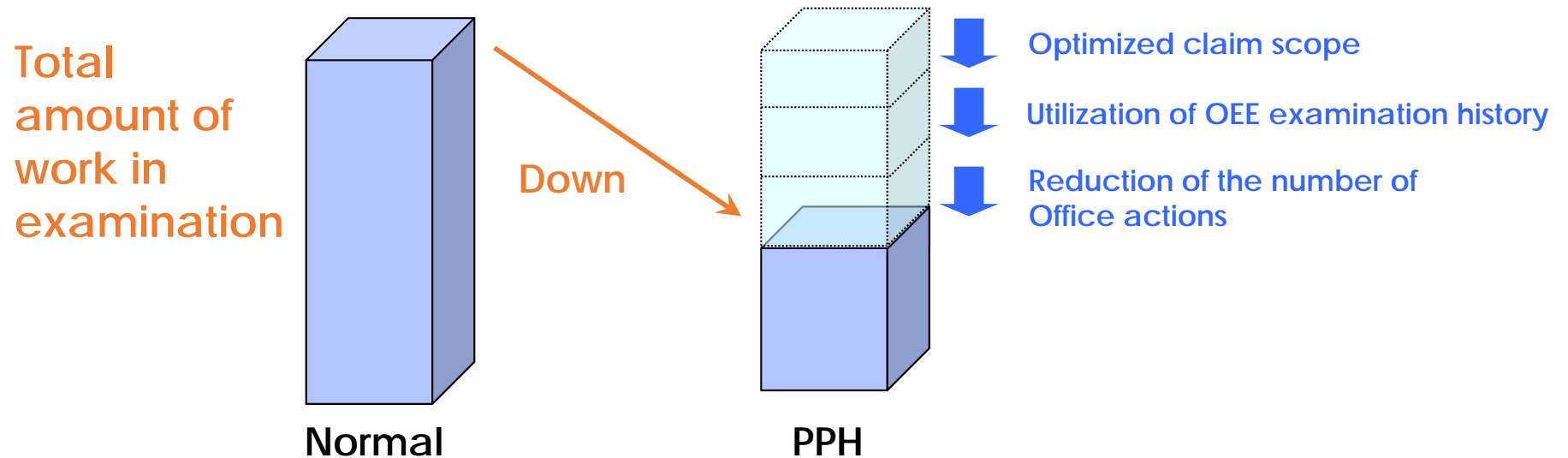



Improvement of examination quality

- ✓ The PPH scheme allows the examination of OLE to have at least the same quality of that of OEE.
- ✓ The OLE examiners can learn from the search and examination practices of the OEE through office actions and prior arts.
- ✓ “Claims correspondence” facilitates understanding.

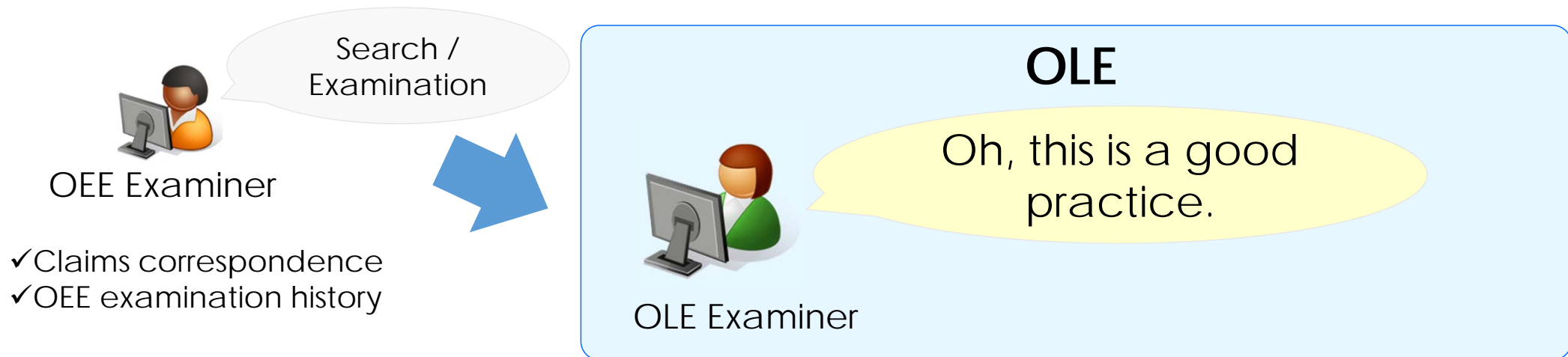



I. Scheme of the PPH



II. Benefits of the PPH



III. How to examine PPH applications



PPH Substantive Examination in OLE

1. Read the claims submitted to OLE



2. Refer to the OEE claims and other documents with IT tools

WIPO-CASE



OLE Claims

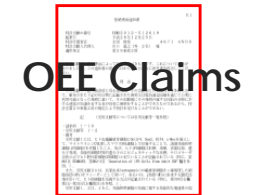

OEE Claims

3. Compare the OLE claims with the OEE claims



OLE Claims

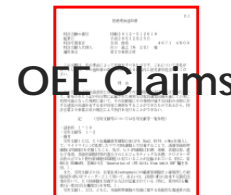

OEE Claims

3'. Refer to the claims correspondence table

Claims in OLE	Patentable claims in OEE	Comments
1	1	Identical
2	2	identical



4. Search prior arts in OLE's database



5. Decision to grant a patent



Required documents for the PPH

1. A copy of all claims and its translation
2. Copies of the OEE office actions and their translations
3. Copies of all cited documents
4. The Claims Correspondence Table

Claims filed with the OLE	Claims determined to be allowable in the OEE	Comments about the correspondence
1	1	Both claims are identical.
2	2	Both claims are identical except for the claim format.
3	1	Claim 3 in the OLE application adds composition A to claim 1 filed with the OEE.



Required documents for the PPH

1.



A copy of all claims and its translation

2.



Copies of the OEE office actions and their translations

3.



Copies of all cited documents

4.



The Claims Correspondence Table

The applicant is not required to submit the copy if it is available on **the Dossier access system**.

If a cited document is **a patent document**, the applicant is not required to submit it.



Claims determined to be patentable/allowable

- At least one corresponding application must exist in the OEE and the application must have one or more claims determined to be patentable/allowable in the latest office action of the OEE.
- The office action does not always need to be a “Decision to grant a patent.” – For example, the office action of JPO includes :
 1. Decision to grant a patent
 2. Notification of reasons for refusal
 3. Decision of refusal
 4. Appeal decision



Claims must sufficiently correspond

OEE claim

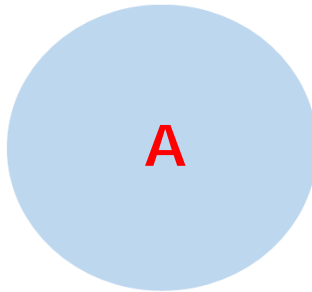

OLE claim

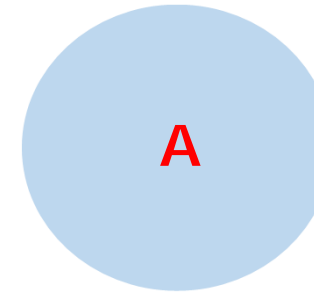

same scope

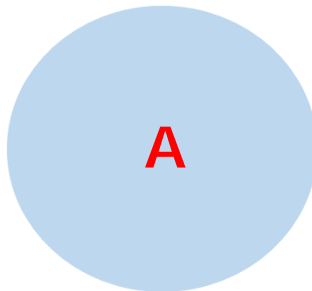

different scope due to translation or claim format

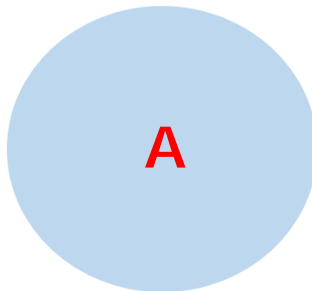
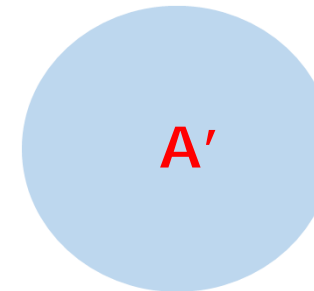

narrower scope

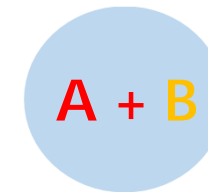

B is a technical feature which is supported in the specification (description and/or claims)

PPH Portal Site

<https://www.jpo.go.jp/e/toppage/pph-portal/index.html>



Thank you.