



REPUBLIC OF SOUTH AFRICA



## **Regional Seminar for Certain African Countries on the Implementation and Use of Several Patent-Related Flexibilities**

***Topic 3: Patent-Related Flexibilities in the Multilateral Legal  
Framework and their Legislative Implementation at the  
National and Regional levels***

**Durban, South Africa  
January 29 to 31, 2013**



## **Regional Seminar for Certain African Countries on the Implementation and Use of Several Patent- Related Flexibilities**

# **Patent Related Flexibilities in the Multilateral Legal Framework**

**Durban, South Africa  
January 29 to 31, 2013**

Marco M. ALEMAN

Deputy Director, Patents Law Division, and Head Legislative and Policy  
Advice Section, WIPO

# Summary

- I. The Multilateral legal framework of patents
- II. The implementation of Multilateral Treaties on Patents
- III. Classification and meaning of Flexibilities
- IV. Some examples of flexibilities
- V. Wipo's Work within the CDIP

# I. The Multilateral Legal Framework

- Total freedom of countries
- 1883: Paris Convention (asymmetries)
- 1994: TRIPS Agreement. The period of minimum standards



## II. Implementation of Multilateral Treaties on Patents

- Direct Implementation vs. Adoption of national laws
- Self executing vs. Non-self executing international law
- Room to manoeuvre left to the national legislator

### III. A Definition of flexibility

- « a range of rights, safeguards and options that WTO Members can exploit in their implementation of the TRIPs Agreement »
- Vague international rules, that need to be circumscribed in their content by the national legislation

# A. Definition

Idea of « alternative ways » for:

- Legislative implementation
- To accommodate national interests

It goes without saying that all this ways must be compatible with the provisions and principles of the Treaty



## B. Classification (1)

- Flexibilities related to transition period and substantive flexibilities
- More elaborate classification:
  1. subject- matter which qualifies for protection
  2. Scope of the protection
  3. Modes of IP enforcement
  4. Matters of administration



## Classification (2)

Flexibilities based on the point in time at which Members may resort to them: i) acquisition of the right; ii) scope of the right and iii) enforcement

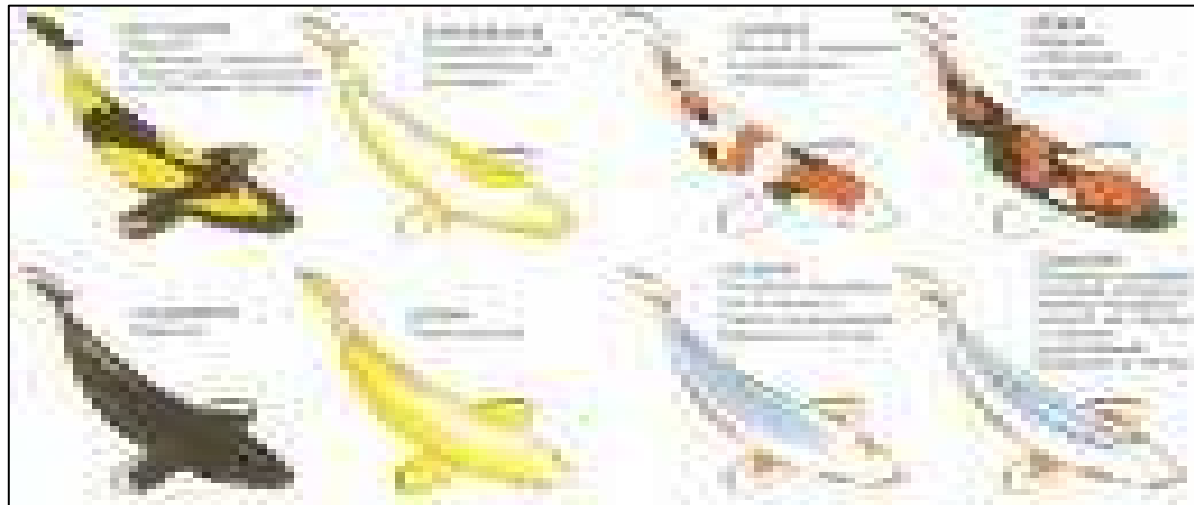

# IV. Identification of some flexibilities

- Compulsory licenses and Government Use
- Exhaustion of rights
- Research exemption
- Regulatory review (*Bolar*) exception
- Utility models ←
- Transition Periods ←
- Disclosure related Flexibilities ←
- Substantive examination ←
- Ex-officio IP Office Control of Anti-competitive clauses in patent licensing agreements ←



# Transition Periods

- Obligation to implement the TRIPs provision within a determined deadline set in the Treaty
- Article 65.2 TRIPs (General transition Period)
- Article 60.4 TRIPs (products patent protection to areas of technology not so protectable within the country when the TRIPs entered into force)
- Art. 70.8 patent protection for pharmaceutical and agricultural chemical products



# General Transition Periods

- Date of entry into force of the TRIPS Agreement: 1st January 1995
- 1st January 1996: 1st deadline
- 1st January 2000: deadline for developing countries (5 years of General Transition Period)
- 1 January 2006: deadline for LDCs (10 years of General Transition Period) → extended up to July 1, 2013



# Pharmaceutical products

- No obligation to implement Sections 5 and 7 of part II of the TRIPs or to enforce the rights thereto up to 2005 (for developing countries) or 2016 (for LDCs)
- Establishment of an Exclusive Marketing Rights (EMR) system during this special transnational periods (but: LDCs not obliged to constitute it)



# Disclosure related flexibilities

- Notion: description of the invention by the inventor/applicant, who shares with society the content of his/her invention making the knowledge contained in the patent application available to everybody in order to stimulate future innovation.

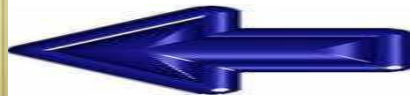
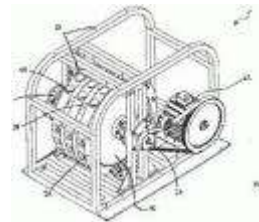
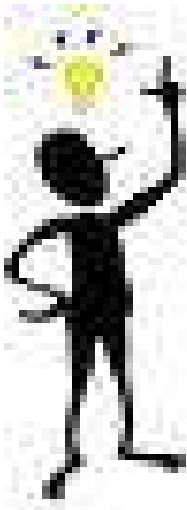

**WIPO**  
WORLD  
INTELLECTUAL PROPERTY  
ORGANIZATION

# Disclosure: main elements

The inventor shall:

- Describe his/her invention clearly enough to allow an expert in the field/skilled in the art, to understand it and make and use it without undue experimentation
- Set the boundaries of what he/she is claiming to be protected by the description → claims shall be supported by the description

# Elements of the disclosure

- Enablement
- Written description
- Best mode

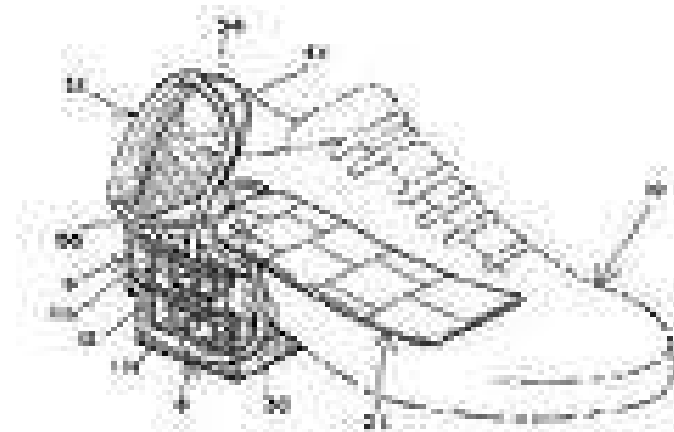

FIG. 2



# International legal framework

## ■ Art. 29.1 TRIPS

- Invention disclosed in a clear and complete manner
- Allowing a person skilled in the art to carry out the invention

## ■ Art. 29.2 TRIPS: information concerning the applicant's corresponding foreign applications and grant



# Other matters related to disclosure not covered by the TRIPS

- Deposit of microorganisms to disclose the invention
- Indication of origin of biological material

# Substantive examination

- Control concerning the compliance with conditions of patentability of the invention
- **Pros:** legal certainty of the patent and confidence in the patent system by society at large
- **Cons:** complex tasks and cost associated with it

# Different options of examination

- Mere formal examination
- Formal examination + prior art search (But: no substantive examination!)
- Substantive examination

# Cooperation for search and examination

- PCT
- Bilateral agreements between Patent Offices
- Cost effective ways to conduct patent search in developing countries and LDCs
  - To use search and examination reports prepared by other offices
  - To require the applicant to submit information concerning searches, grants or refusal of equivalent applications in other countries
  - Entrust prior art search and examination to other POs
  - To rely on PCT reports
  - To use the WIPO service within the ICE

# International legal framework

- Art. 12 of the Paris Convention
  - Special Industrial Property Service
  - Publish an Official Periodical Journal (proprietors of the patents granted and a brief designation of the invention)
- Art. 62 of the TRIPS
  - Subsection 1: principle of reasonableness of procedure
  - Subsection 2: taking place of the procedure within a reasonable period of time

# Ex-officio IP Office control of anti-competitive clauses in patent licensing agreements

Apparent tension between IP and Competition policies

IP system

Promotion of innovation through granting a patent right

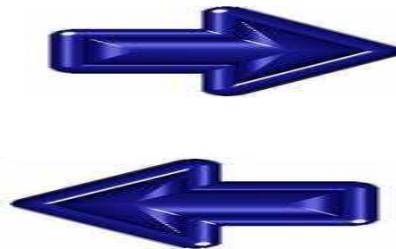

Competition policies

avoid market barriers

# Interface IP system-Competition Policies

- **But:** common goal of IP system and Competition Policies:  
Enhancing consumer welfare



**Licensing agreements:** area where this interface is particularly evident



# Examples of clauses that may be found anti-competitive under certain circumstances

- Grant back clauses
- Cross-licensing clauses



- Ex-ante control of the IP Office on voluntary license agreements: measure to avoid such clauses

# International legal framework (1)

## ■ Article 8.2 TRIPS

“Appropriate measures, provided that they are consistent with the provision of this Agreement, may be needed to prevent the abuse of intellectual property rights by right holders or the resort to practices which unreasonably restrain trade or adversely affect the international transfer of technology”

# International legal framework (2)

- Article 40.2 TRIPs:

gives Members the room to *manœuvre* for specifying in their legislation licensing practices or conditions that may in particular cases constitute an abuse of IPRs having an adverse effect on competition

# National legal framework

- IPRs abuses as well as anticompetitive clauses of technology transfer as part of general Competition Law
- Patent Law containing a reference to clauses deemed null and void because anti-competitive and remedy left to the Civil Code
- Patent Law containing a reference to clauses deemed null and void because anti-competitive and power to the IP Office to refuse the registration of the license contract containing them

## ■ V. WIPOs work at the CDIP

# WIPO Surveys and Discussions

- Patent Related Flexibilities Document's in the framework of the CDIP

- 1) CDIP/5/4Rev

- [http://www.wipo.int/edocs/mdocs/mdocs/en/cdip\\_5/cdip\\_5\\_4-main1.pdf](http://www.wipo.int/edocs/mdocs/mdocs/en/cdip_5/cdip_5_4-main1.pdf)

- [http://www.wipo.int/edocs/mdocs/mdocs/en/cdip\\_5/cdip\\_5\\_4-annex1.pdf](http://www.wipo.int/edocs/mdocs/mdocs/en/cdip_5/cdip_5_4-annex1.pdf)

- [http://www.wipo.int/edocs/mdocs/mdocs/en/cdip\\_5/cdip\\_5\\_4-annex2.pdf](http://www.wipo.int/edocs/mdocs/mdocs/en/cdip_5/cdip_5_4-annex2.pdf)

- 2) CDIP/7/3 and Add

- [http://www.wipo.int/edocs/mdocs/mdocs/en/cdip\\_7/cdip\\_7\\_3-main1.pdf](http://www.wipo.int/edocs/mdocs/mdocs/en/cdip_7/cdip_7_3-main1.pdf)

- [http://www.wipo.int/edocs/mdocs/mdocs/en/cdip\\_7/cdip\\_7\\_3-annex1.pdf](http://www.wipo.int/edocs/mdocs/mdocs/en/cdip_7/cdip_7_3-annex1.pdf)

- [http://www.wipo.int/edocs/mdocs/mdocs/en/cdip\\_7/cdip\\_7\\_3-annex2.pdf](http://www.wipo.int/edocs/mdocs/mdocs/en/cdip_7/cdip_7_3-annex2.pdf)

- Tenth Session of the CDIP (Nov 12-16, 2012). Future work on patent related flexibilities (CDIP/10/11)

- Regional meeting

- WIPO Seminar for certain Asian countries on the effective implementation and use of several patent related flexibilities, Bangkok, Thailand, February 15 to 17, 2011

- [http://www.wipo.int/meetings/en/details.jsp?meeting\\_id=22602](http://www.wipo.int/meetings/en/details.jsp?meeting_id=22602)

- WIPO Regional Seminar on the Implementation and Use of Several Patent-Related Flexibilities, February 6 to 8, 2012, Bogota, Colombia

- [http://www.wipo.int/meetings/en/details.jsp?meeting\\_id=24982](http://www.wipo.int/meetings/en/details.jsp?meeting_id=24982)

# Statistics: Compulsory Licenses (For non-working)

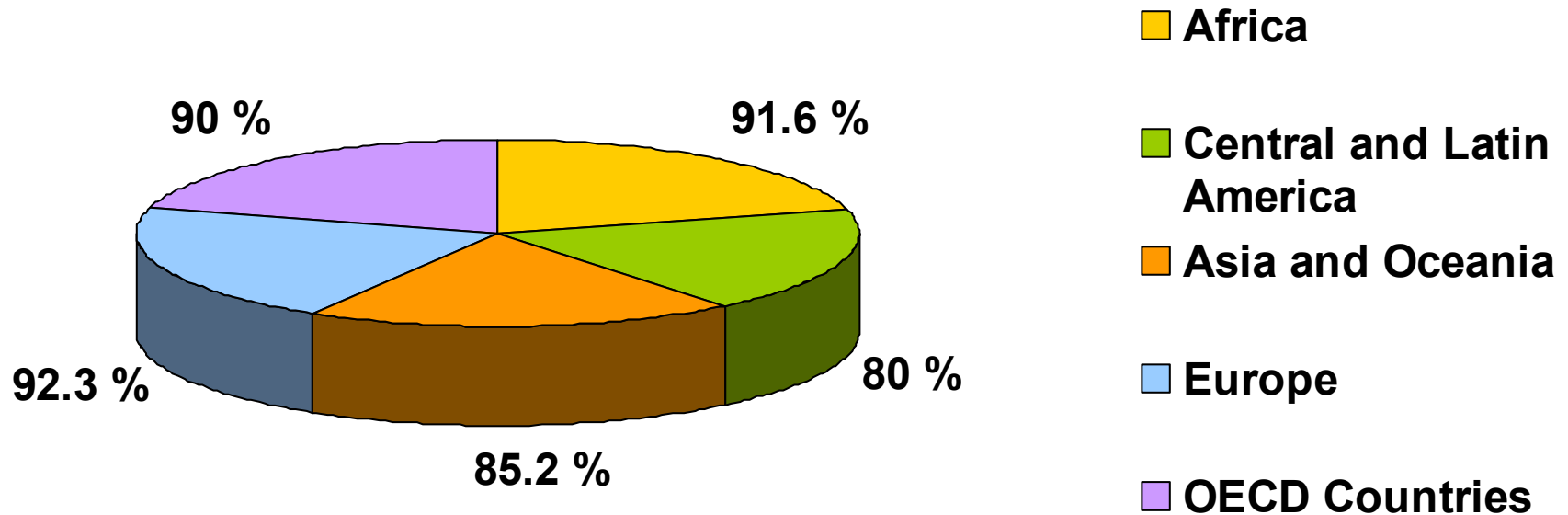

# Statistics: Compulsory Licenses (For dependent patent)

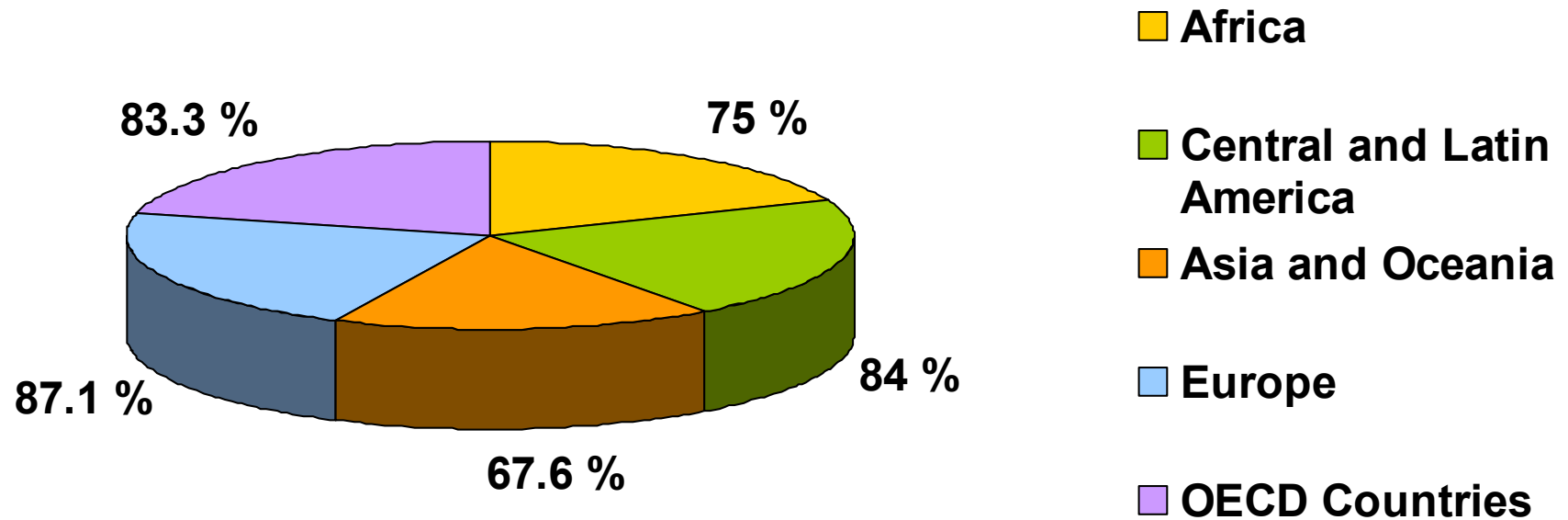



# Statistics: Compulsory Licenses (To correct patent abuse)

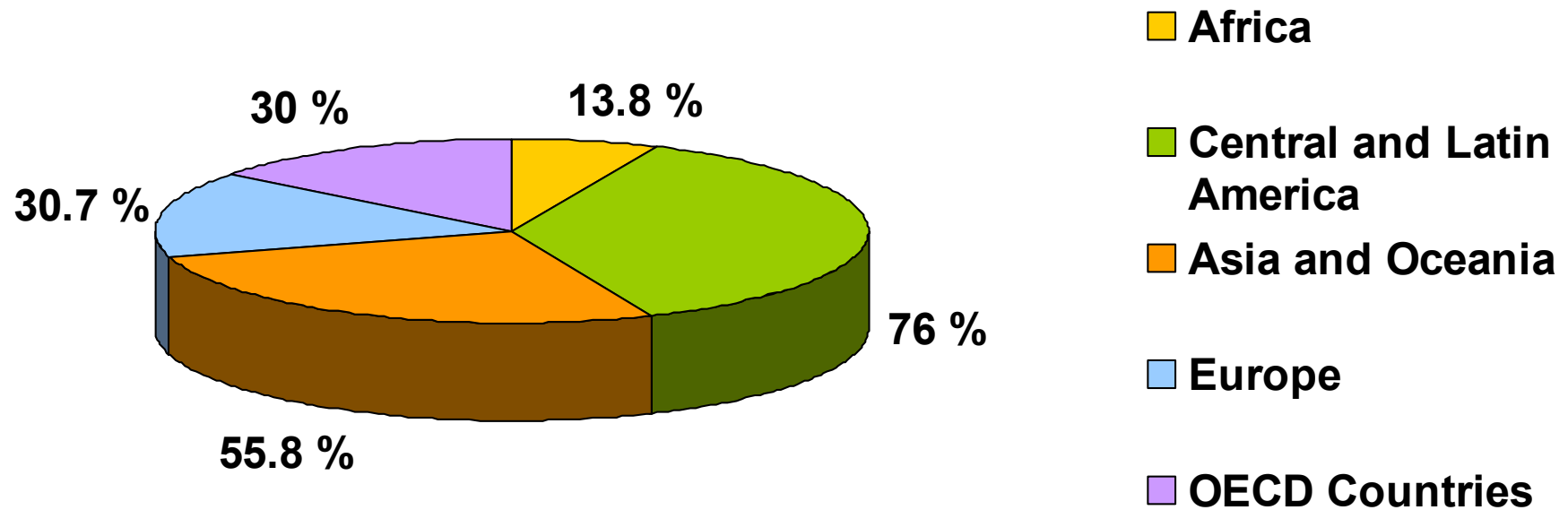

# Statistics: Compulsory Licenses (For public interest)

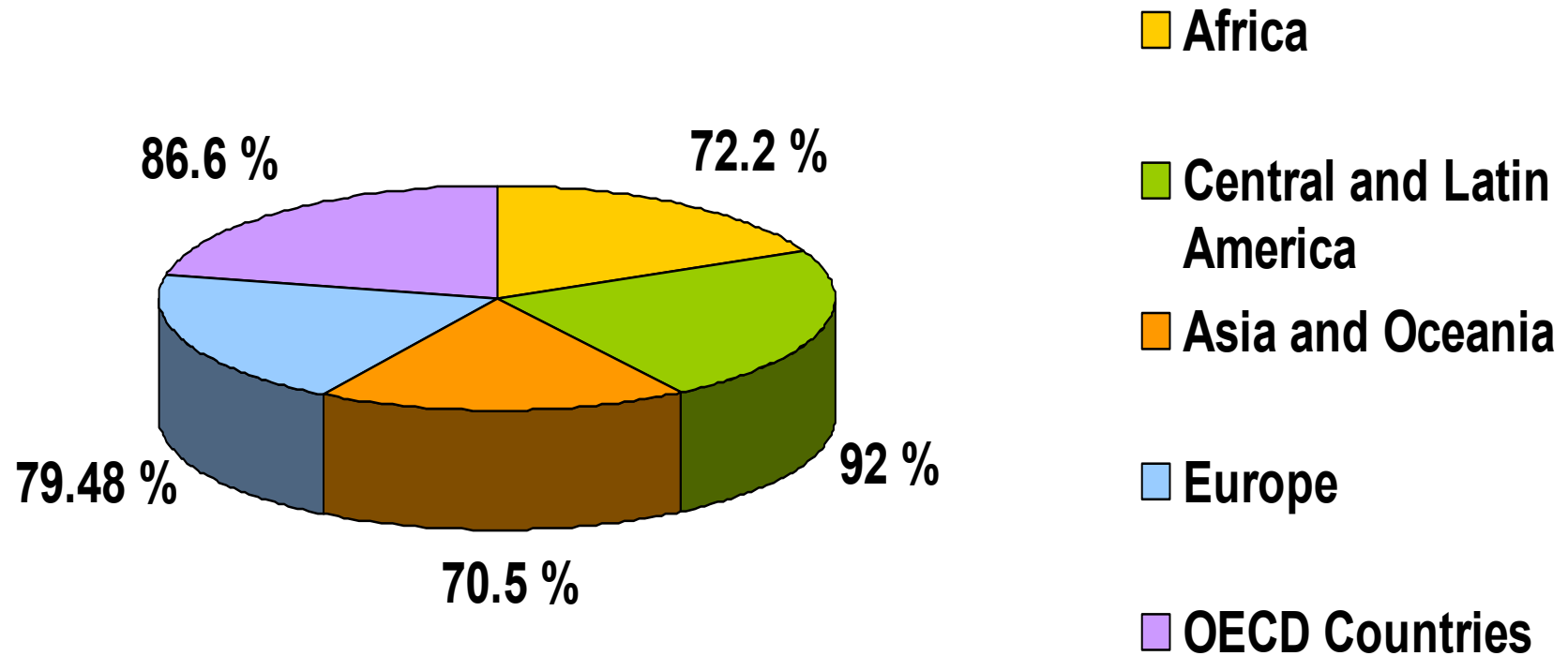

# Statistics: Compulsory Licenses (Government use)

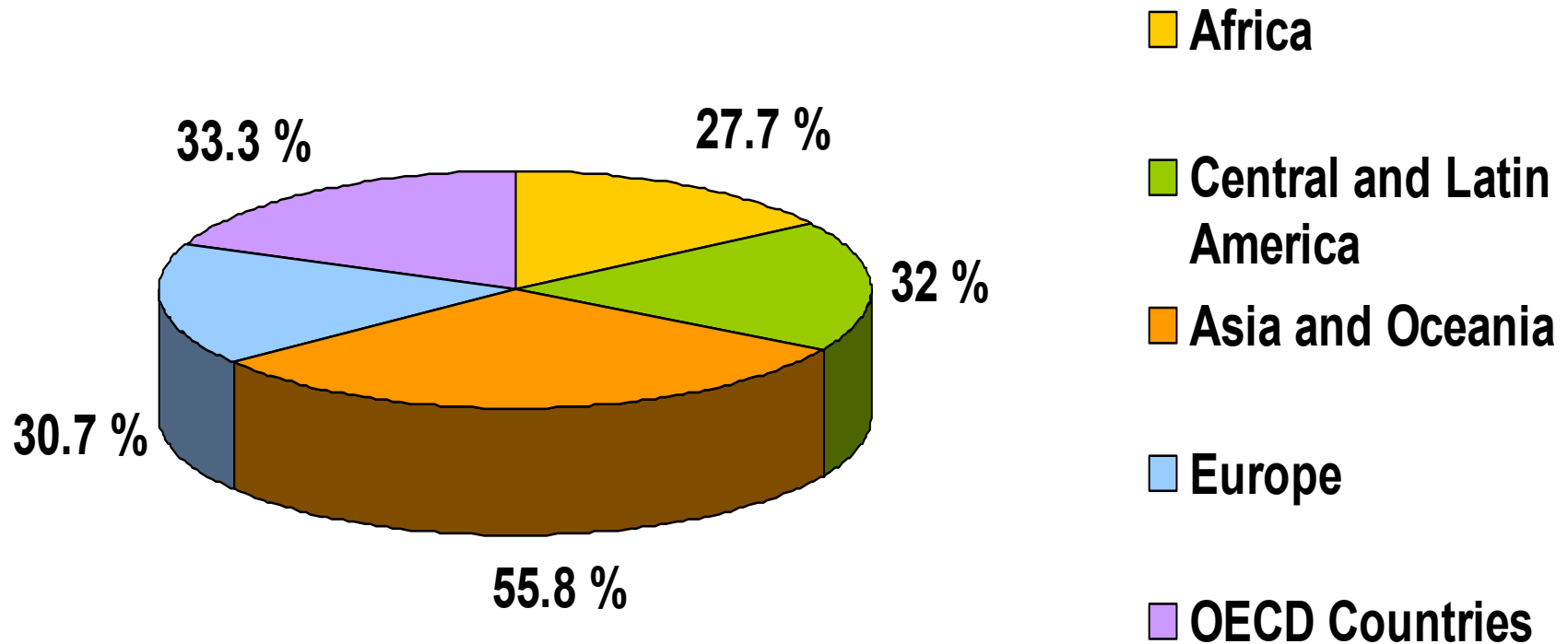

# Statistics: Compulsory Licenses (Implementation of the Decision of the General Council)

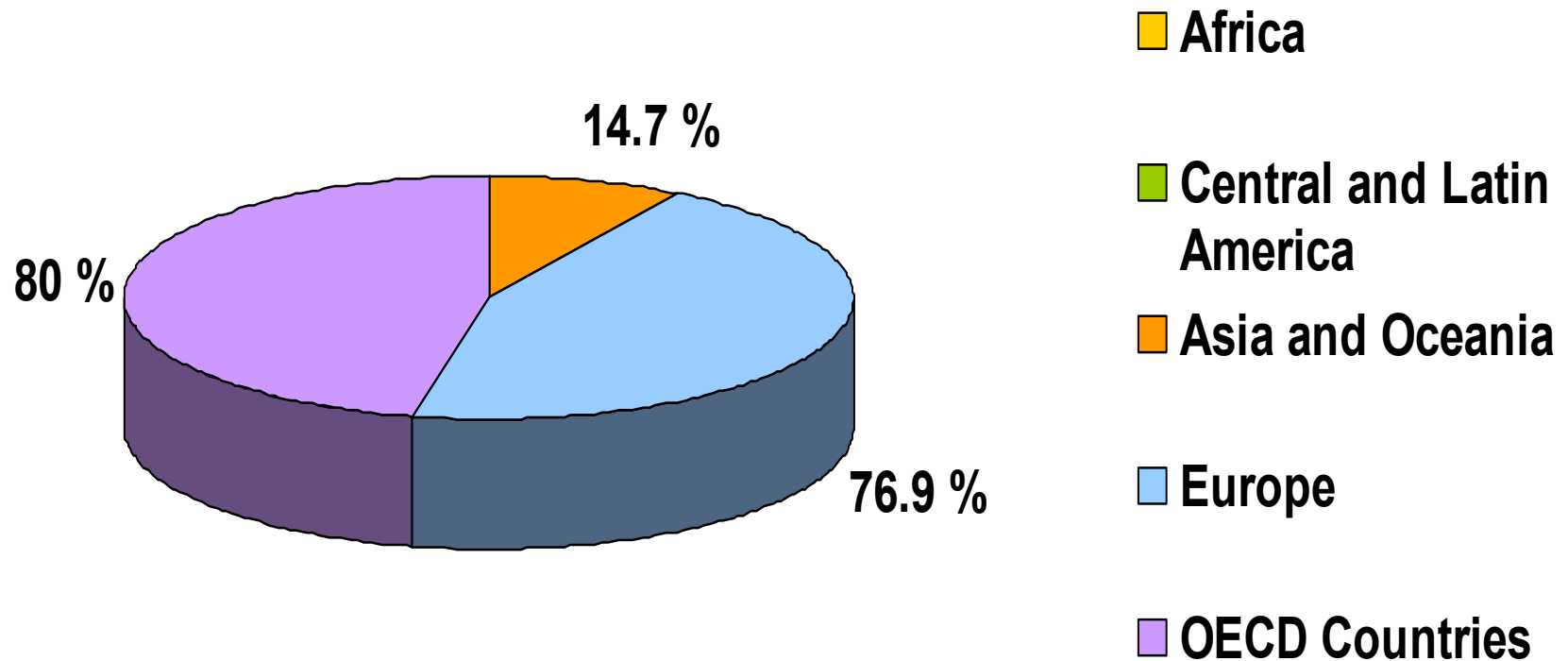

# Statistics: Research and Bolar exception

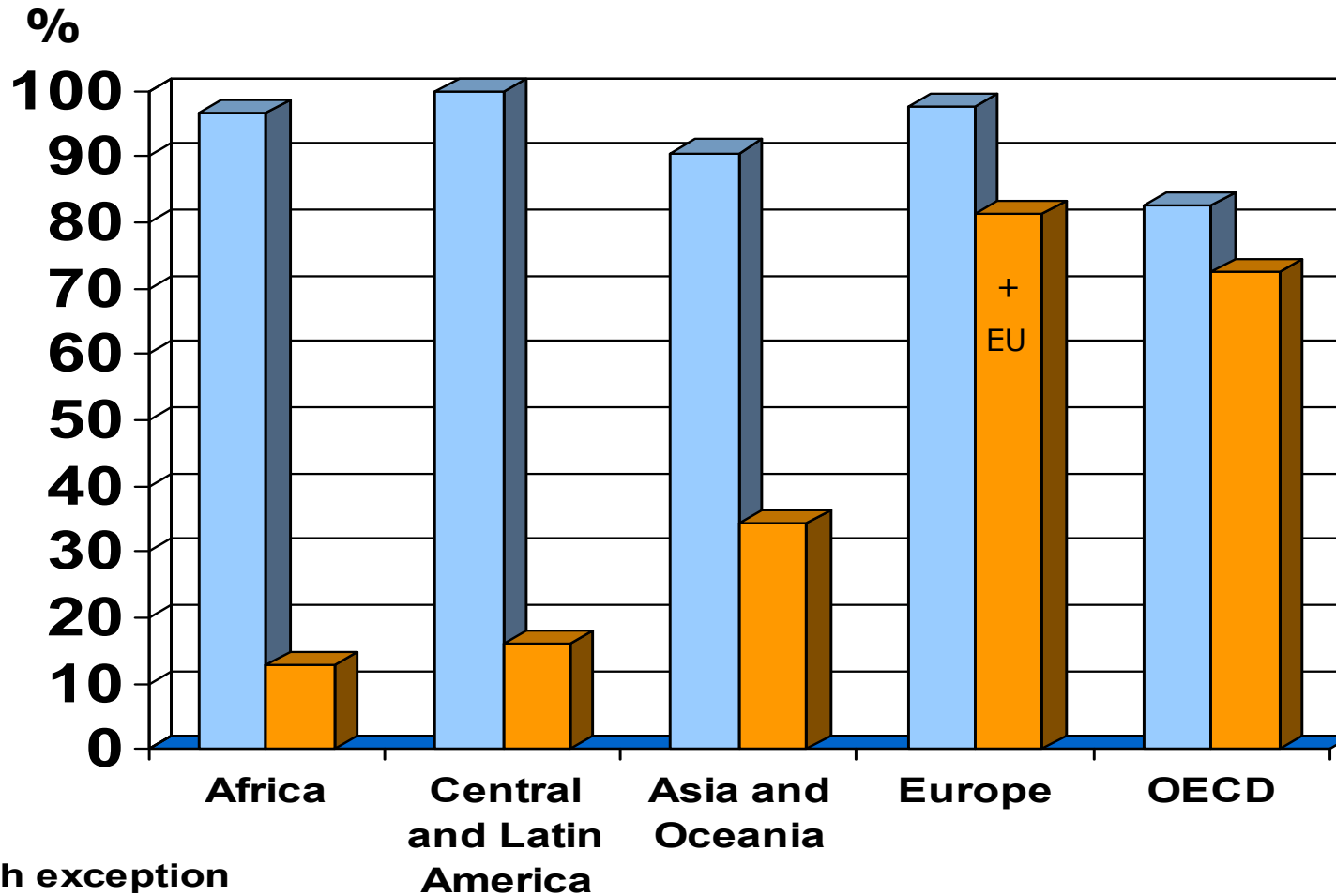

■ Research exception  
■ Bolar exception

# Countries analyzed: Research and Bolar exception

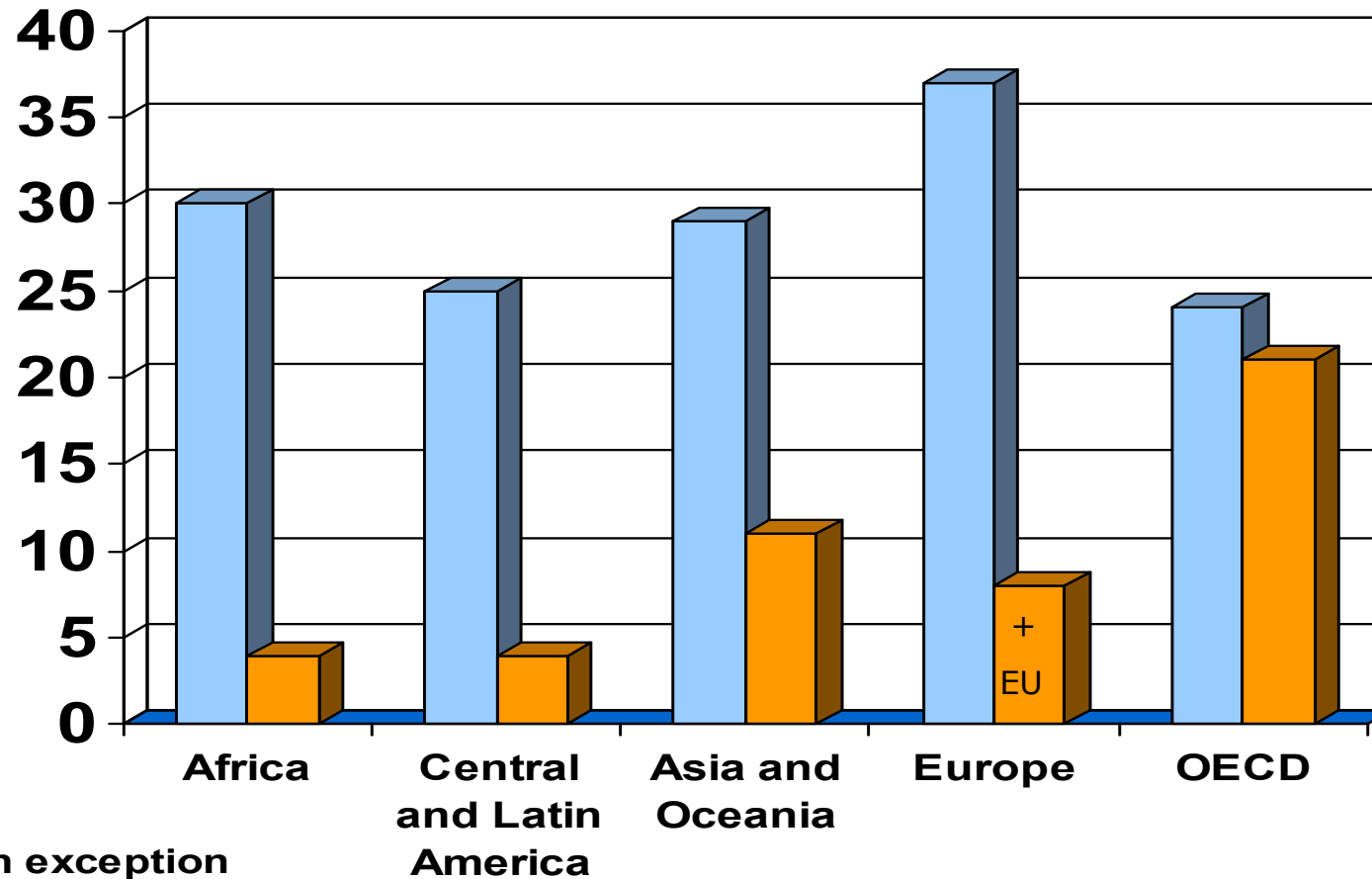

■ Research exception  
■ Bolar exception

# Disclosure related flexibilities (1)

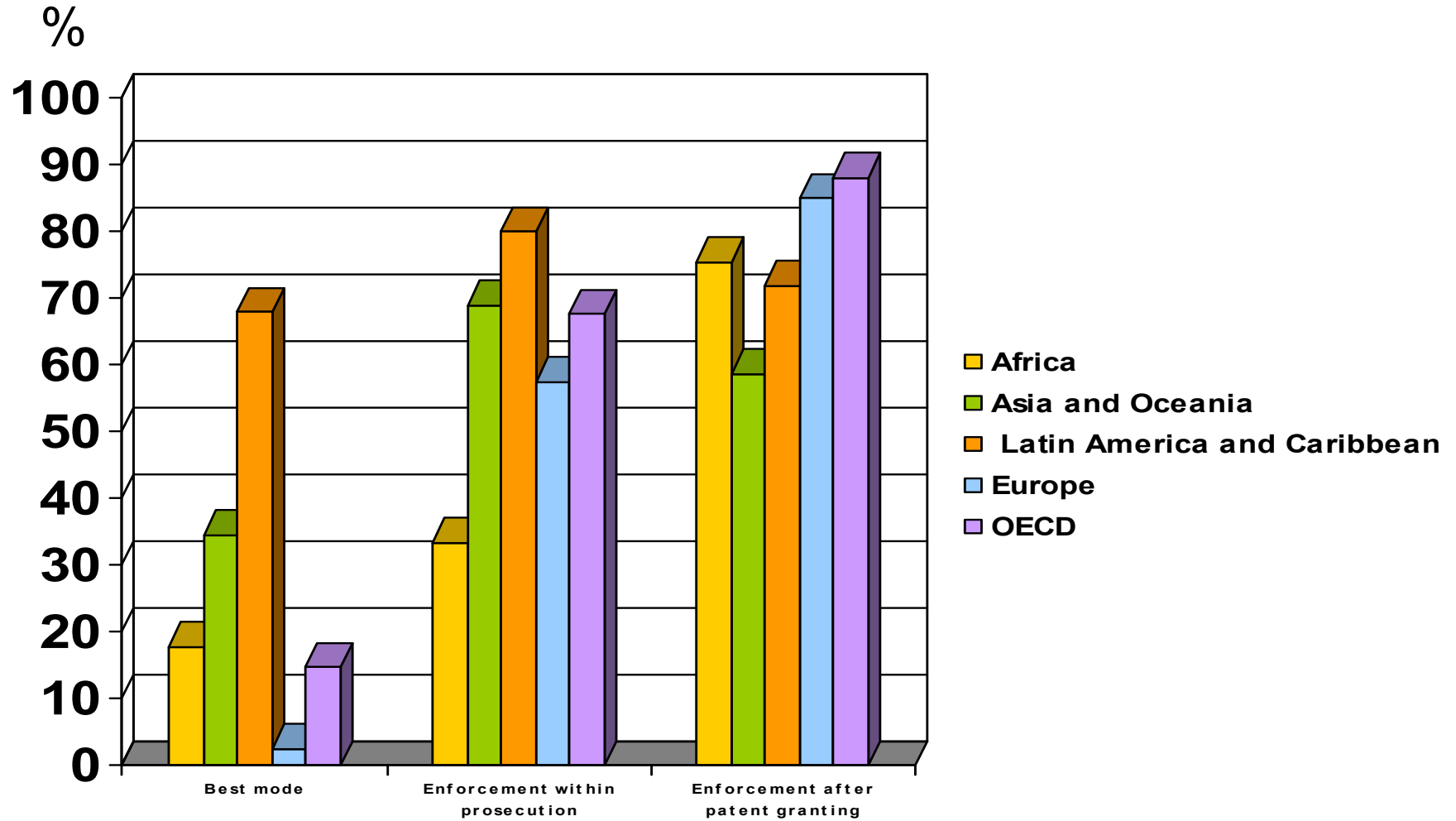

# Countries analyzed: Utility Models

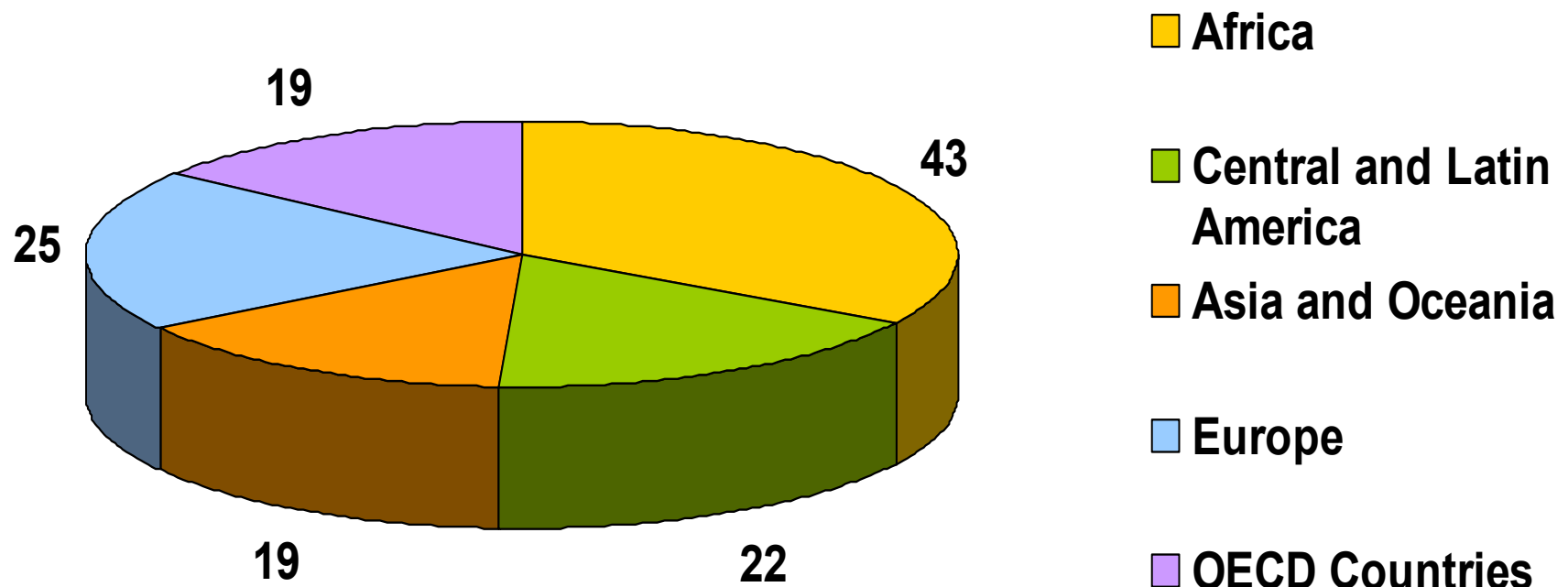



# Disclosure related flexibilities (2)

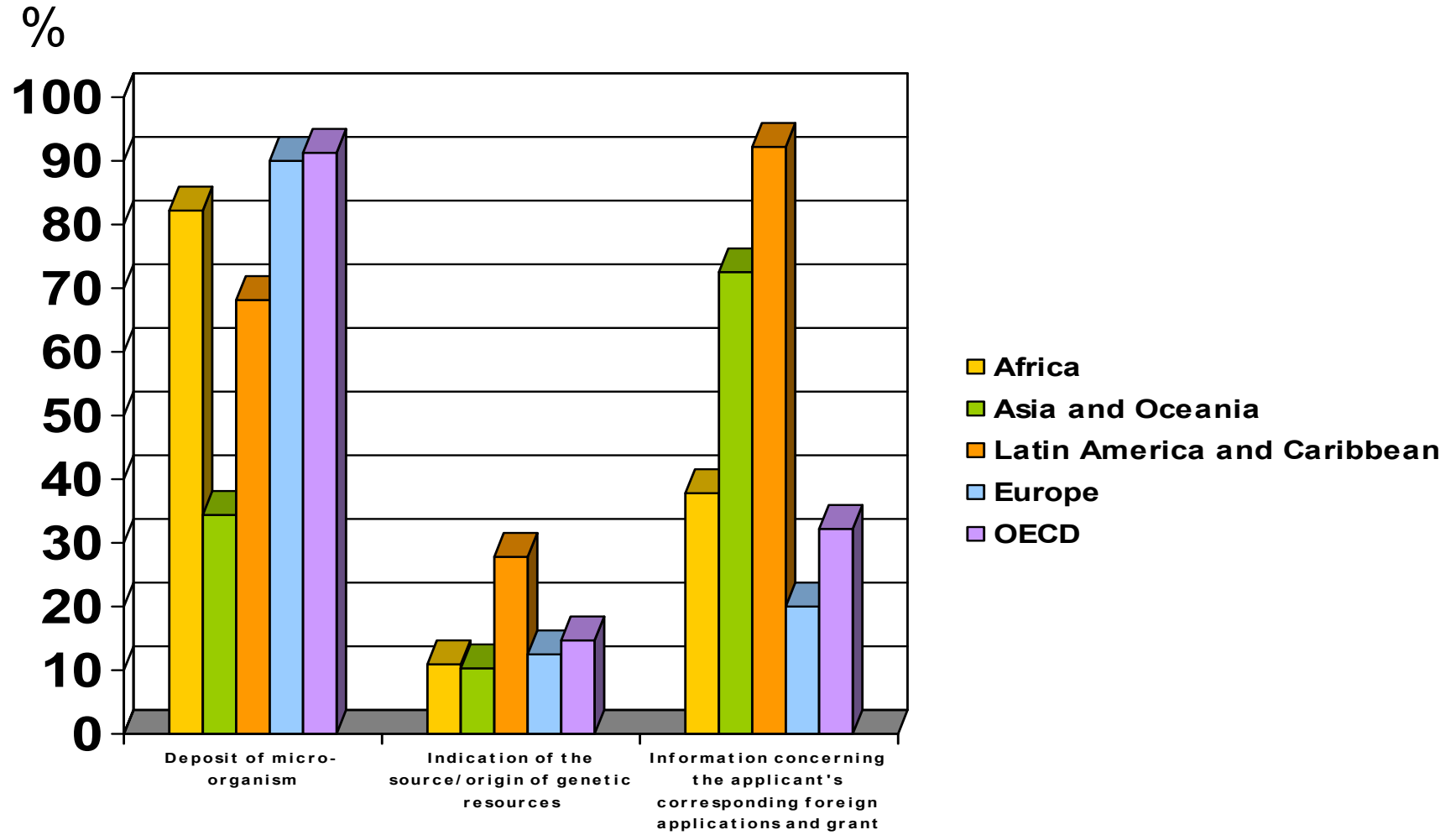

# Substantive examination (1)

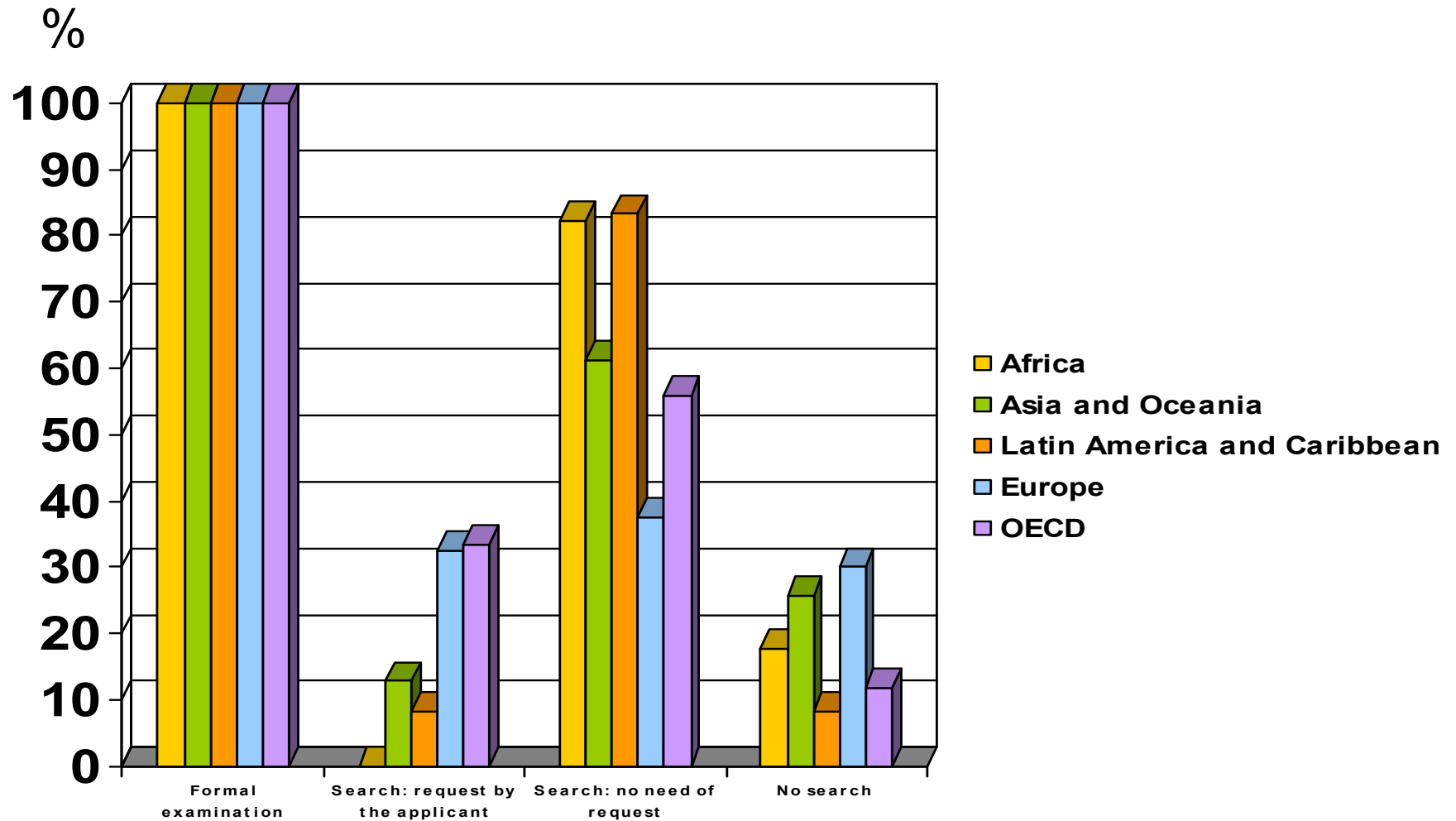

# Substantive examination (2)

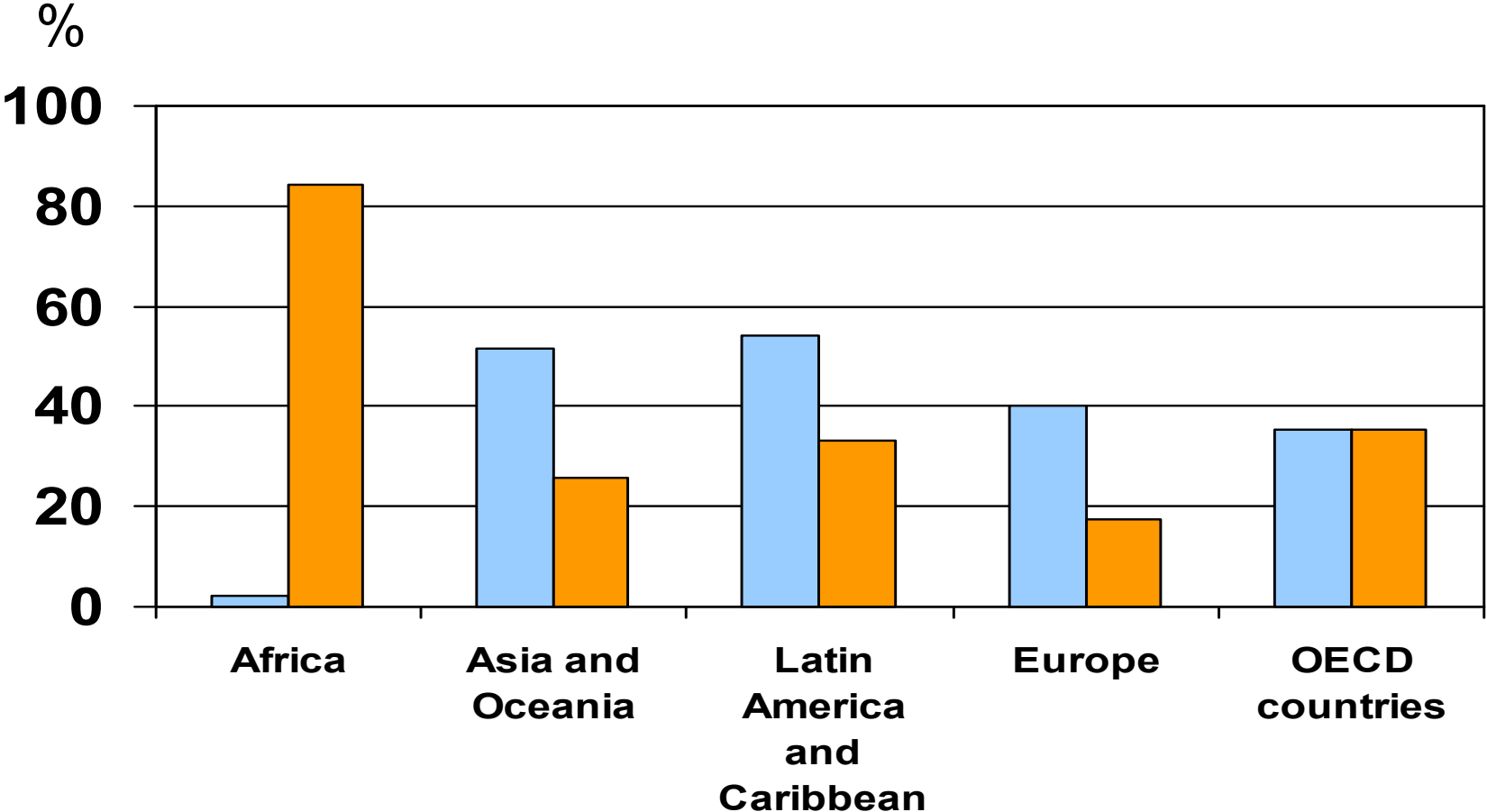

Substantive examination:

Request needed No request needed

# Substantive examination (3)

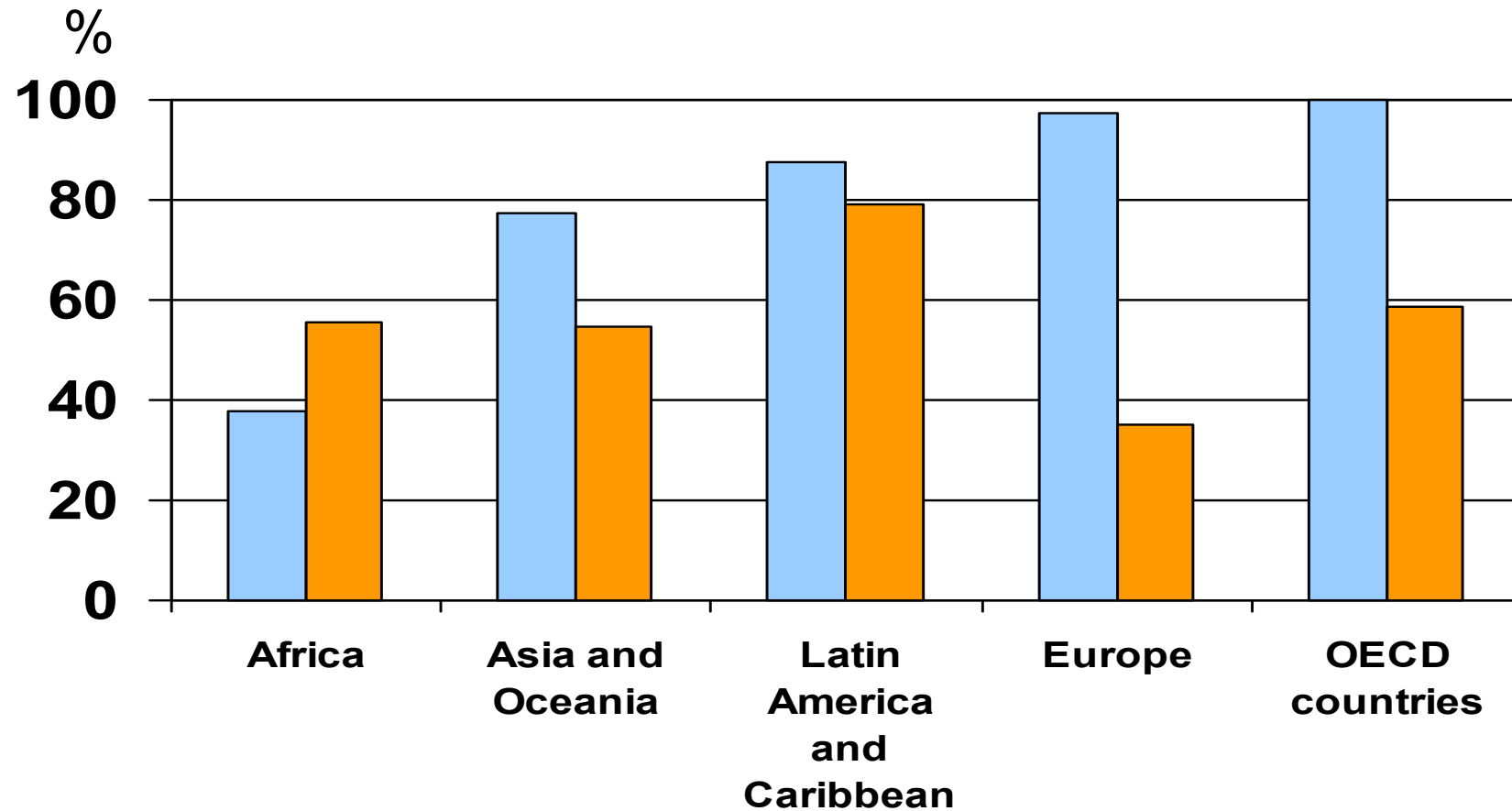

Cooperation for examination:

■ PCT Member ■ Recognition of work carried out by others

# Ex officio IP office control of anti-competitive clauses in licensing agreements

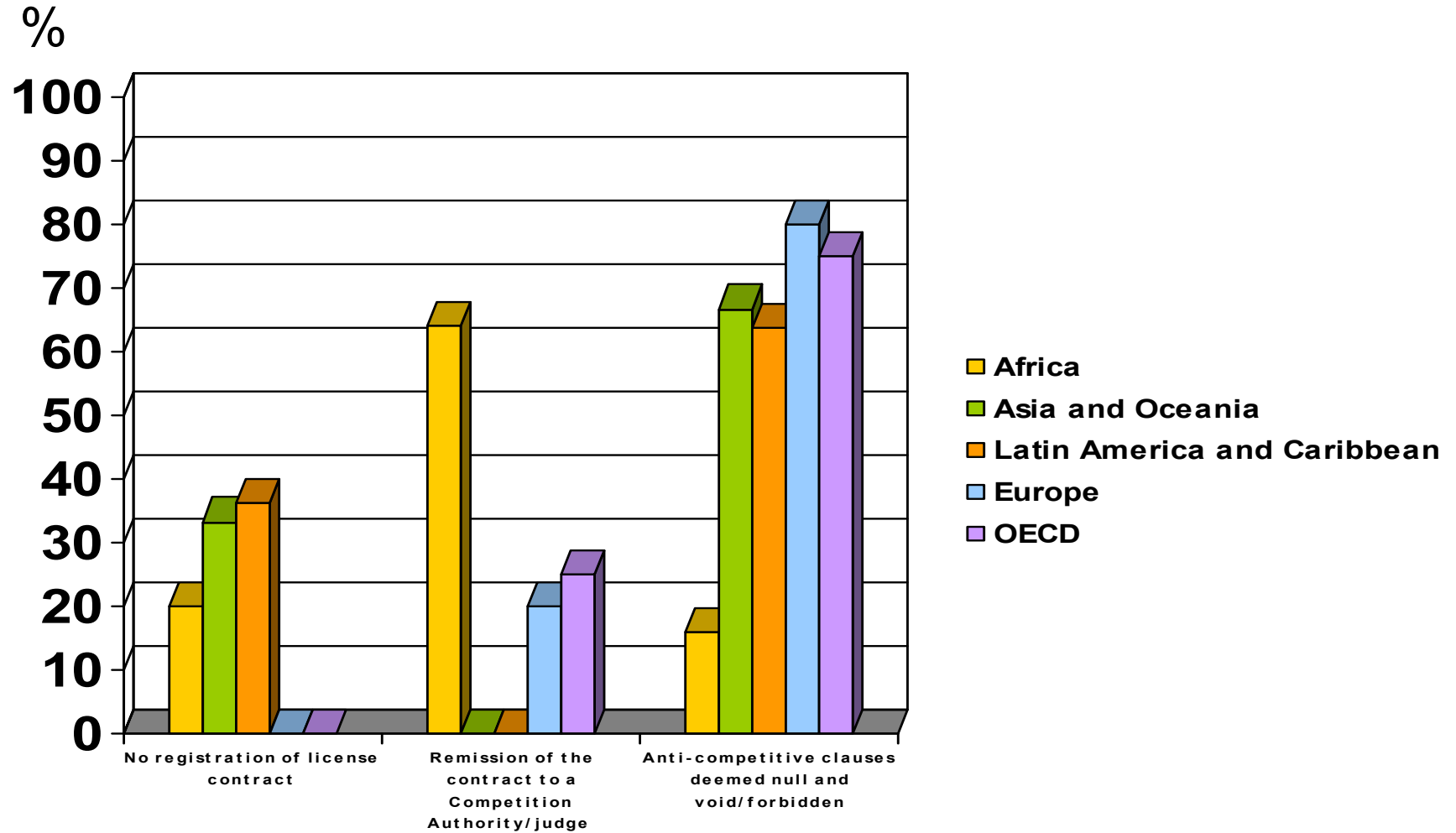



# Thank You!

[Marco.Aleman@wipo.int](mailto:Marco.Aleman@wipo.int)