



Roving Seminar on WIPO Services and Initiatives

Organized by the World Intellectual Property Organization (WIPO)

in cooperation with the American Intellectual Property Law Association (AIPLA) and with the support of the United States Chamber of Commerce (USCC)



Introduction to WIPO



Speaker: Mr. John Sandage
Deputy Director General,
Patents and Technology Sector, WIPO

E-mail: john.sandage@wipo.int

San Jose, United States of America
October 31, 2016

WIPO



***MISSION:** To lead the development of a balanced and effective international intellectual property (IP) system that enables innovation and creativity for the benefit of all.*

- **MEMBER STATES:** 188
- **OBSERVERS:** more than 390 (NGOs, IGOs, industry groups, etc.)
- **STAFF:** more than 1. 200
- **ADMINISTERED TREATIES:** 26
- **MAIN BODIES:** General Assembly, CC, WIPO CONFERENCE

WIPO is Service and Development oriented

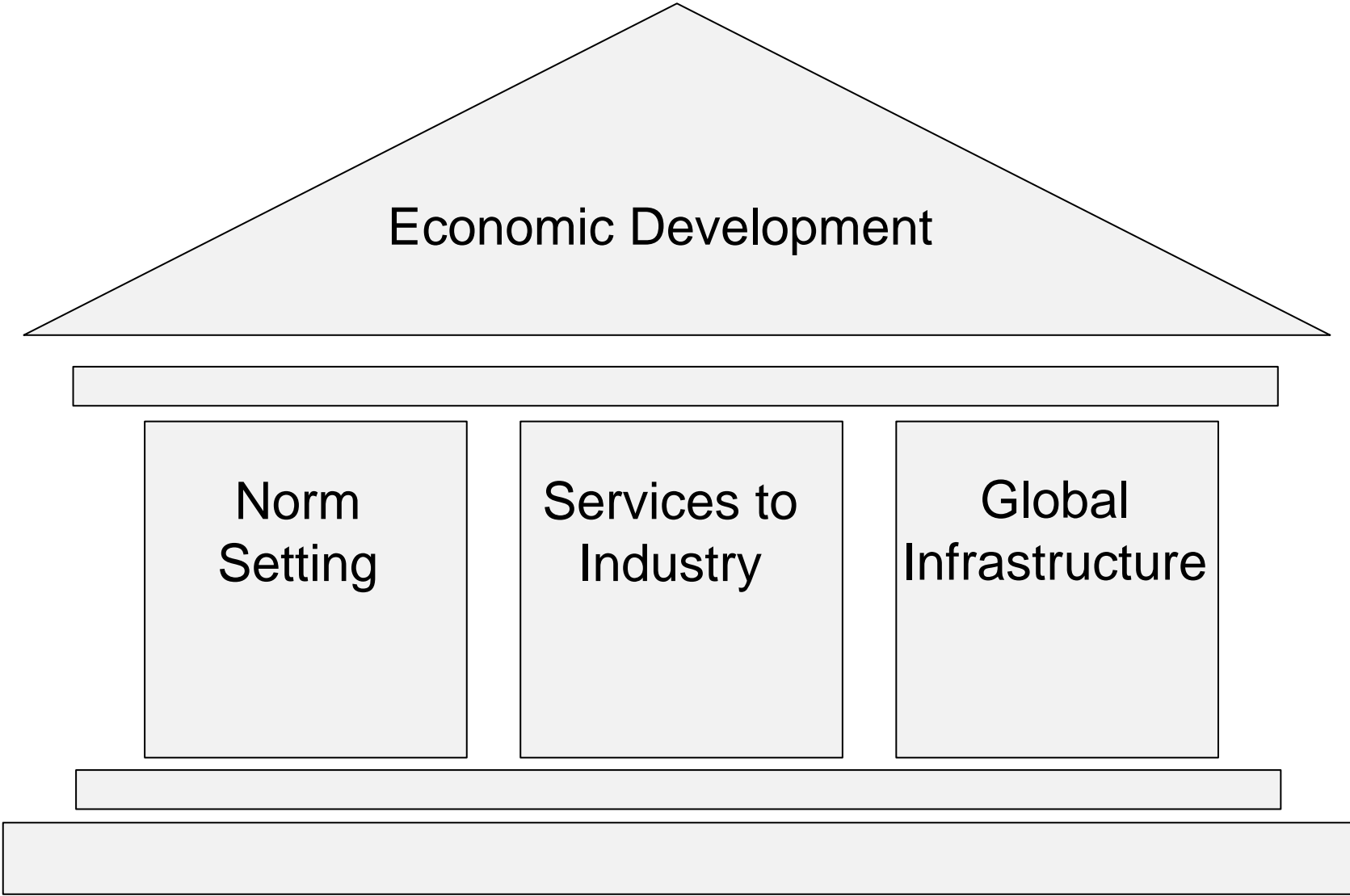

ACCESS TO INTERNATIONAL MARKETS

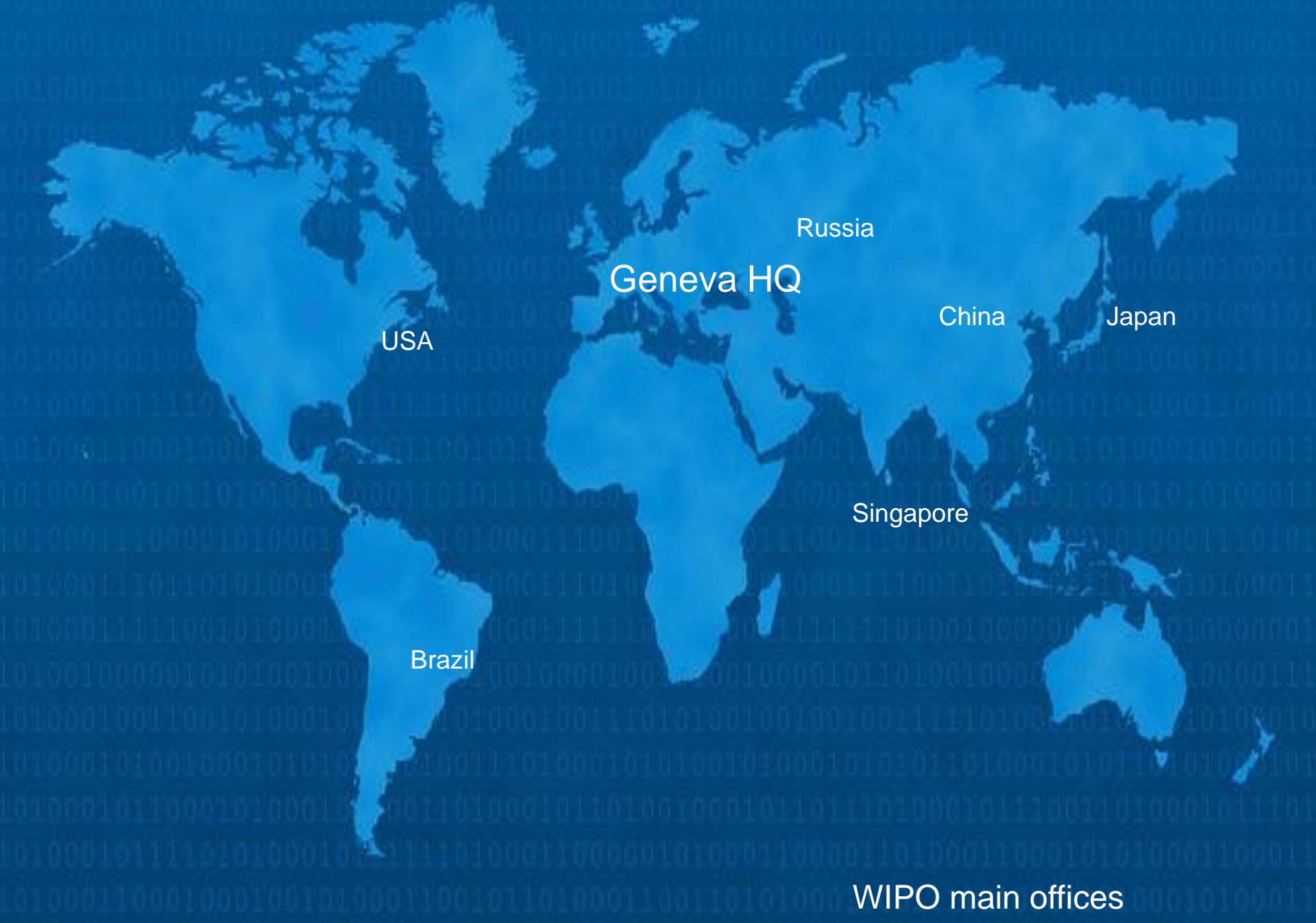

WIPO main offices

WIPO: Provider of Premier Global IP Services

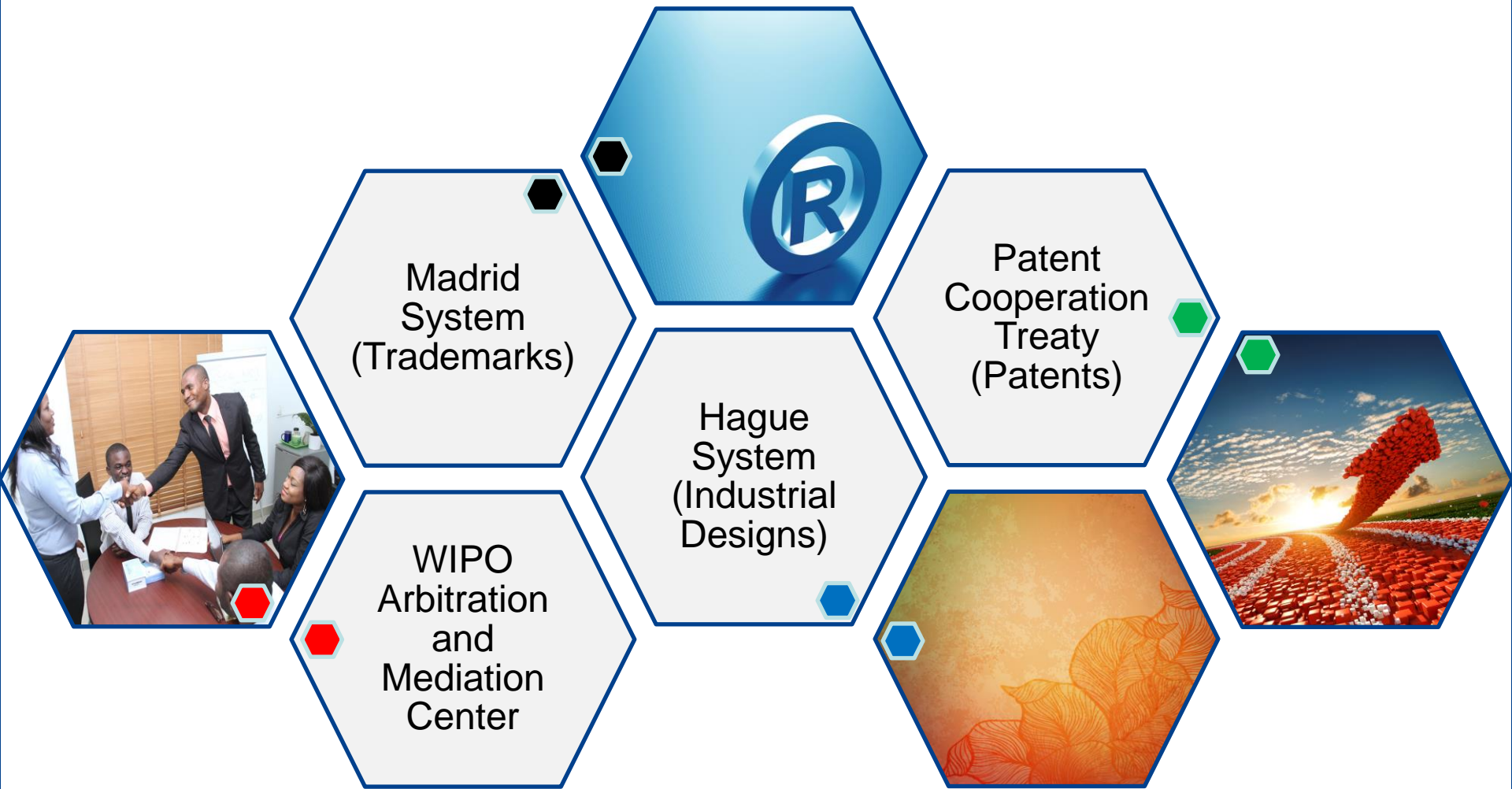

WIPO's Budget: 756,3 Million CHF for 2016 - 2017

Budget by income

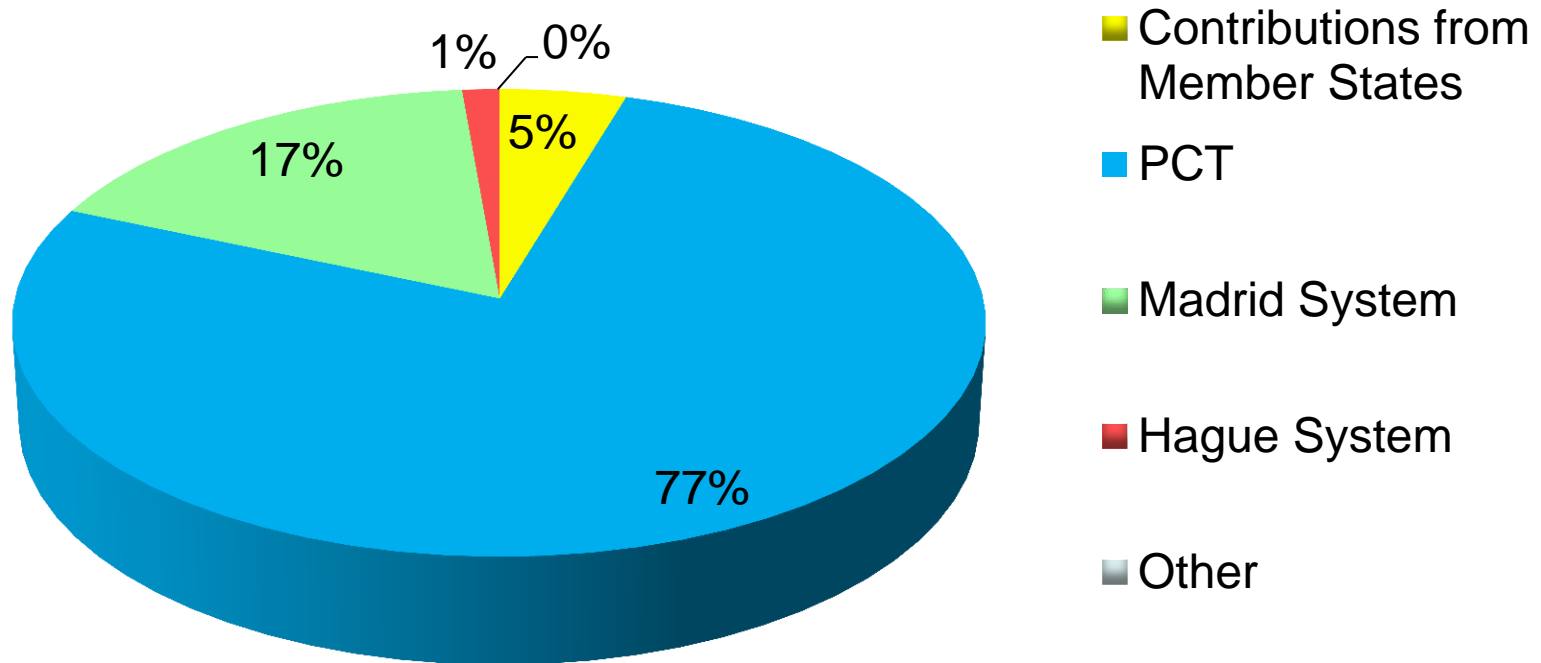

PCT Applications

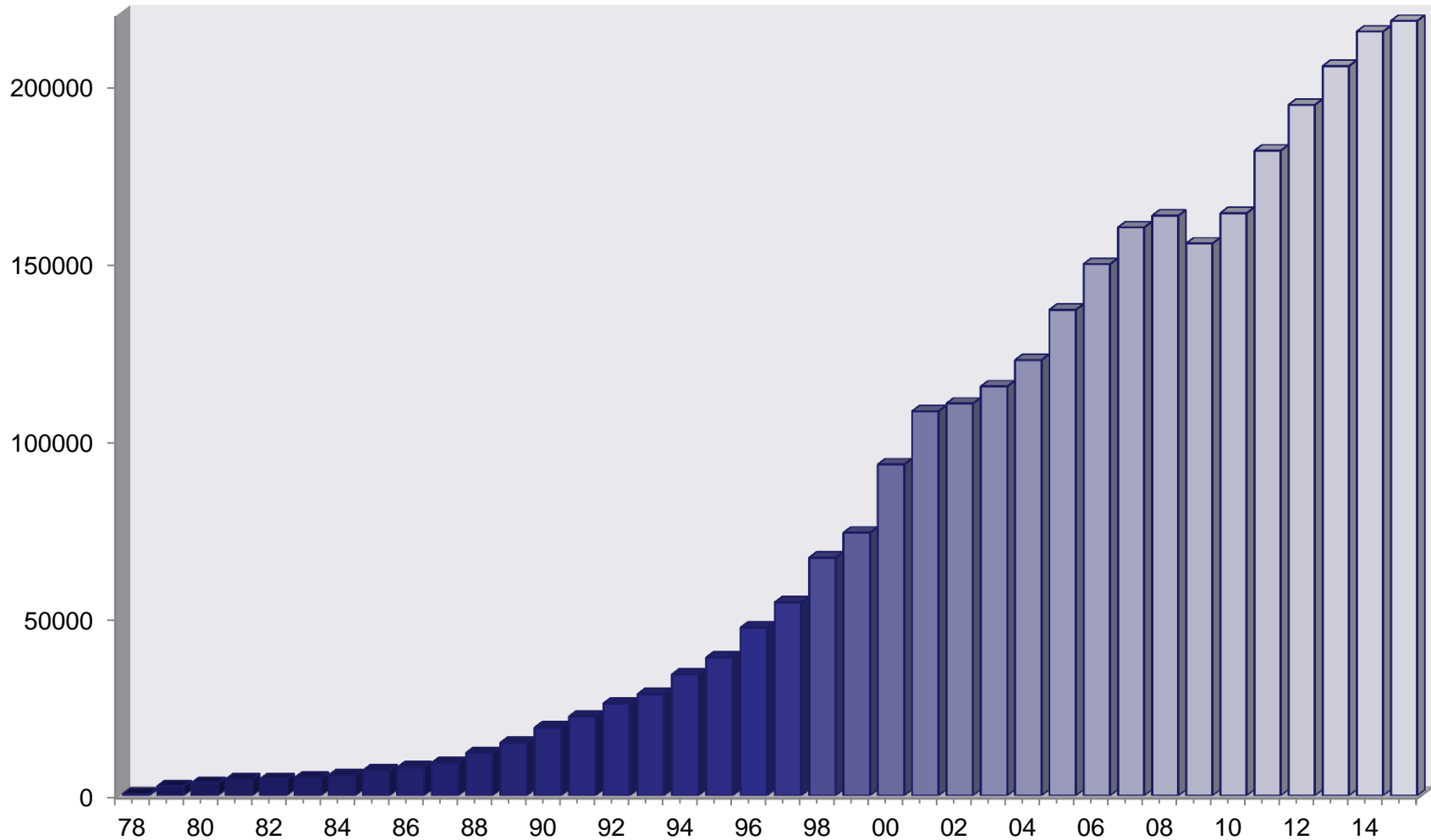

2015: 218,000 (+1.7%)

PCT Operations at a glance:

- WIPO's International Bureau received 220,000 record copies in 2014, growing 3% over the prior biennium:
 - USA was first, with 57,000 filings.
 - The share of fully electronic filings continued to increase, now 91% of all filings.
- Number of PCT Staff is decreasing:
 - The number of PCT staff has been reduced by 33% -- from a high of 456 to 296 over the last 12 years – a reduction of 160 FTEs.
 - But – Examiner productivity has risen 22%.
- Quality of work by IB is improving:
 - Overall output quality has increased from 81% to 93%.
 - Due mainly to improved timeliness and reduced errors.
- No fee increase in 7 years!

WIPO Systems – and now The Hague!

- Patent Cooperation Treaty (PCT)
- Madrid System
- Alternative Dispute Resolution
- The Hague System
 - Second largest filer worldwide is Procter and Gamble (US), with 95 filings
 - Among the top five origins, the United States of America saw the fastest growth in the number of registered designs (+14.2%)

Industrial Design Applications

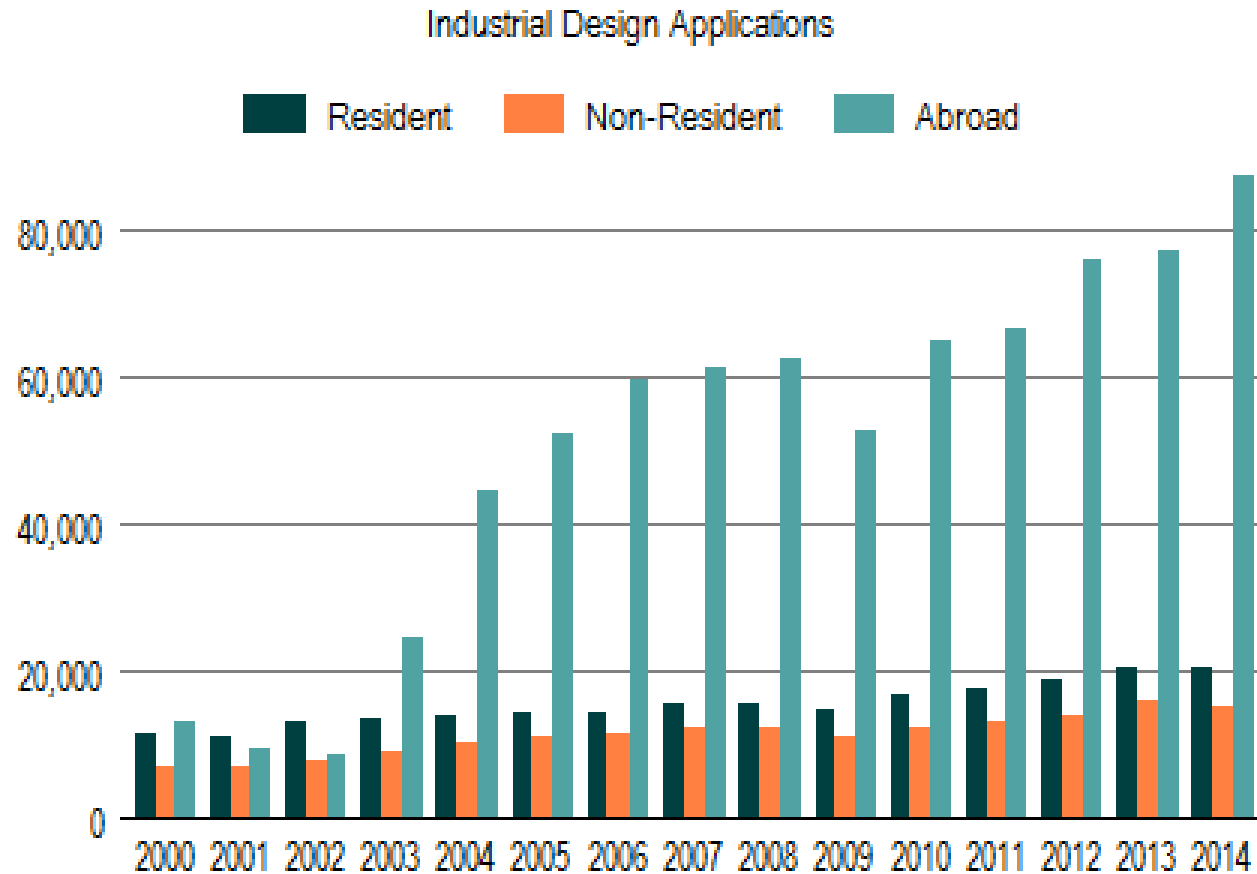

Source: WIPO statistics database; last updated: 12/2015

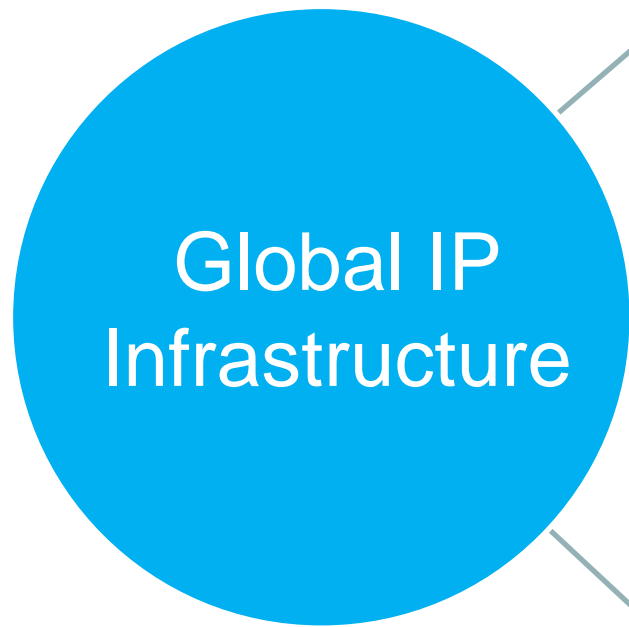

Global IP Infrastructure

Repositories of Information

- Databases e.g. Patentscope and Global Brand Database

Platforms

- Common platform for e-data exchange among IPOs: IPAS, DAS
- Other platforms: WIPO GREEN and WIPO Re:Search

Treatment of Information

- International Classification Systems (Organize into indexed, manageable structures for easy retrieval)
- Standards for IP Offices (Help streamline data processing)

World Intellectual
Property Report

Statistics Series

Patent Cooperation Treaty
Yearly Review

Statistics Series

Madrid
Yearly Review

Statistics Series

Hague
Yearly Review

Statistics Series

WIPO IP Facts
and Figures

Statistics Series

World Intellectual
Property Indicators

Economics & Statistics Series

- **World Intellectual Property Report (2015): Breakthrough Innovation and Economic Growth**
- **The PCT Yearly Review** provides an overview of the performance and development of the PCT system:
<http://www.wipo.int/ipstats/en/statistics/pct/>
- **Madrid Yearly Review:**
<http://www.wipo.int/ipstats/en>
- **Hague Yearly Review:**
<http://www.wipo.int/ipstats/en/>
- **The WIPO IP Facts and Figures** provides an overview of IP activity based on the latest available year of statistics. It serves as a quick reference guide for statistics: <http://www.wipo.int/ipstats/en/>
- **World Intellectual Property Indicators (WIPI)** provides an overview of latest trends in IP filings and registrations covering more than 100 offices:
<http://www.wipo.int/ipstats/en/wipi/index.html>
- **WIPO IP Statistics Data Center**
<http://ipstatsdb.wipo.org/ipstatv2/ipstats/patentsSearch>

Country Profile



The Global Innovation Index

RANKING 2015

1. SWITZERLAND
2. UNITED KINGDOM
3. SWEDEN
4. NETHERLANDS
- 5. UNITED STATES OF AMERICA**
6. FINLAND
7. SINGAPORE
8. IRELAND
9. LUXEMBURG
10. DENMARK
11. HONG KONG (CHINA)
12. GERMANY
13. ICELAND
14. KOREA, REPUBLIC OF
15. NEW ZEALAND

RANKING 2016

1. SWITZERLAND
2. SWEDEN
3. UNITED KINGDOM
- 4. UNITED STATES OF AMERICA**
5. FINLAND
6. SINGAPORE
7. IRELAND
8. DENMARK
9. NETHERLANDS
10. GERMANY
11. KOREA, REPUBLIC OF
12. LUXEMBOURG
13. ICELAND
14. HONG KONG (CHINA)
15. CANADA

Top PCT Applicants 2015*

() of published
PCT applications

1. Huawei Technologies—CN (3,898)** +450
2. Qualcomm—US (2,442)
3. ZTE—CN (2,155)
4. Samsung—KR (1,683) +300, up from #11
5. Mitsubishi Electric—JP (1,593)
6. Ericsson—SE (1,481)
7. LG Electronics—KR (1,457) +320, up from #16
8. Sony—JP (1,381) +400, up from #21
9. Philips—NL (1,378)
10. Hewlett-Packard—US (1,310) +485, up from #25
11. Siemens—DE (1,292)
12. Intel—US (1,250)
13. Bosch—DE (1,247)
14. Boe Technology—CN (1,227)
15. Toyota—JP (1,214)
16. Panasonic—JP (1,185)
17. Hitachi—JP (1,165)
18. Halliburton—US (1,121)
19. Sharp—JP (1,073)
20. Tencent Technology—CN (981)

2015:

- 85% businesses
- 8% individuals
- 5% universities
- 2% government and research institutions

*48,539 total PCT
applicants in 2015

**more than 15
per WIPO working
day

Top University PCT Applicants 2015

1. *University of California (US)*
2. *MIT (US)*
3. *Johns Hopkins (US)*
4. *University of Texas (US)*
5. *Harvard University (US)*
6. *University of Michigan (US)*
7. *University of Florida (US)*
8. *Tsinghua University (CN)*
9. *University of Tokyo (JP)*
10. *Stanford University (US)*
11. *Seoul National University (KR)*
12. *Peking University (CN)*
13. *Columbia University (US)*
14. *Isis Innovation Limited (GB)*
15. *Cornell University (US)*
16. *University of Pennsylvania (US)*
17. *Kyoto University (JP)*
18. *Korea University (KR)*
19. *CalTech (US)*
20. *Danemarks Tekniske Universitet (DK)*

Follow us

- Twitter: [@wipo](https://twitter.com/wipo)
- WIPO Magazine
www.wipo.int/wipo_magazine/en/
- WIPO Wire:
www.wipo.int/newsletters/en
- Press releases
www.wipo.int/pressroom/en/



Thank you for your attention



The International Registration of Trademarks, Using the Madrid System

Roving Seminar on WIPO Services and Initiatives



Matthew Forno
Senior Counsellor
Information and Promotion Division
Brands and Designs Sector, WIPO

**San Jose, United States of America
October 31, 2016**

It begins with a trademark and a plan to export...



DAIMLER



ORKA GROUP
"FASHION IS OUR BUSINESS"

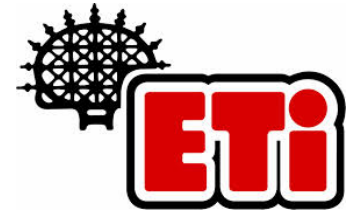

SHISEIDO

MICROMAX

syngenta



TREASURY
WINE ESTATES



DZAMA

SONY®



Protection Options

...Then a choice must be made regarding the best way to protect your trademark/s abroad:

- The national route - file trademark application/s with the IP Office of each country in which you want protection
- The regional route - apply through a regional trademark registration system with effect in all member states (ARIPO, Benelux Office for IP, EUIPO and OAPI)
- The international route - file through the Madrid System

The International Route

The international route through the Madrid System may be the preferred option when you:

- Seek protection in multiple markets, particularly if these are in different regions
- Want flexibility to add new markets as your export plans develop
- Have limited budget and/or time to spend on registration and management of your trademarks

The Madrid System is Convenient

- Access a centralized filing and management procedure
- File one application, in one language and pay one set of fees for protection in multiple markets
- Expand protection to new markets as your business strategy evolves

The Madrid System is Cost-effective

- File an international application, which is the equivalent of a bundle of national applications, effectively saving time and money
- Avoid paying for translations into multiple languages or working through the administrative procedures of multiple IP Offices

The Madrid System offers Broad Geographic Coverage

- Protect your trademark/s simultaneously in the 114 countries covered by the 98 members of the System
- Access markets that represent in excess of 80% of world trade, with potential for expansion as membership grows
- Recent accession include –
 - 2013: India, Rwanda and Tunisia
 - 2014: OAPI and Zimbabwe
 - 2015: Algeria, Cambodia, The Gambia and Lao PDR
 - 2016: Brunei Darussalam

Members of the Madrid System

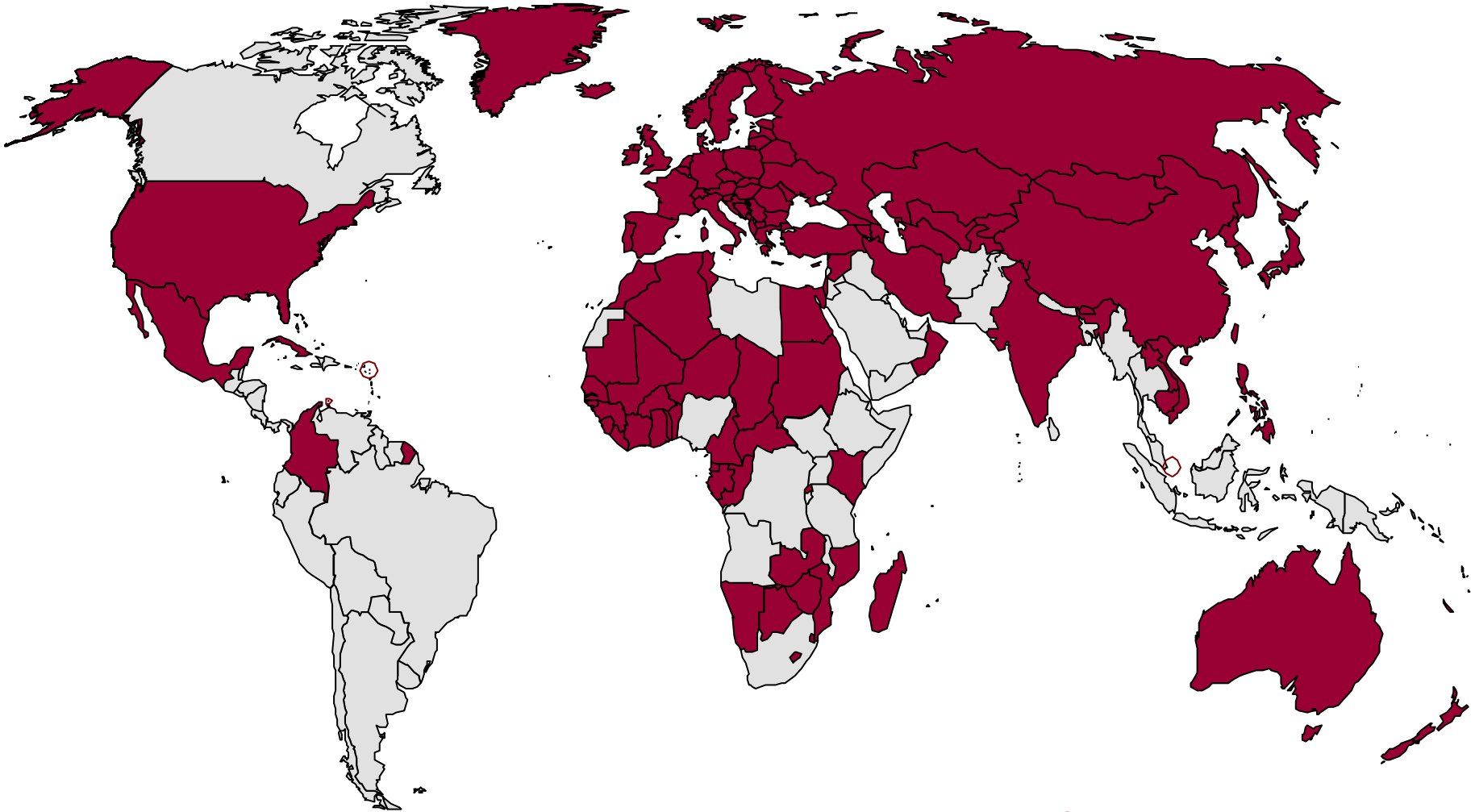

**98 members* (including EU and OAPI)
covering 114 countries**

WIPO
WORLD
INTELLECTUAL PROPERTY
ORGANIZATION

*All are party to the Protocol, the governing treaty, while 55 are also party to the Agreement

How the Madrid System Works

The International Trademark Registration Process



Stage 1

Application through your National or Regional IP Office (**Office of origin**)

- To be **entitled to use** the Madrid System, you must:
 - Have a real and effective industrial or commercial establishment in, or
 - Be domiciled in, or
 - Be a national of a member of the Madrid System

- Before filing an international application, you need to have registered or filed an application (**basic mark**) in your Office of origin

- Submit an **international application** through this same IP Office, which will certify and forward it to WIPO

Stage 2

Formal examination by WIPO

- WIPO conducts a **formalities examination** of your international application
- Once requirements have been met, the mark is **recorded in the International Register**
- WIPO sends a **certificate of international registration** to the holder and notifies the IP Offices, of the **designated Contracting Parties**, in which protection is sought
- The scope of protection is not known at this stage. It is only determined **after substantive examination** and decision by the IP Offices, as outlined in Stage 3

Stage 3

Substantive examination by IP Offices (Office of the designated Contracting Party)

- IP Offices make a **decision within 12 or 18 months** in accordance with their legislation. WIPO records the decisions and notifies you
- If an IP Office refuses to protect your mark, it will not affect the decisions of other offices. You can contest a refusal decision before the IP Office concerned
- If an IP Office accepts to protect your mark, it will issue **statement of grant of protection**
- The international registration is **valid for 10 years**. Renew directly with WIPO with effect in the designated Contracting Parties

Costs

Fees are payable to WIPO in Swiss francs

- Basic fee*, which includes 3 classes of goods/services
 - 653 Swiss francs - b/w reproduction of mark
 - 903 Swiss francs - color reproduction of mark

- Fees for designating Contracting Parties (dCP)
 - Standard fees - complementary (100 Swiss francs per dCP and supplementary (100 Swiss francs per class beyond 3)
OR
 - Individual fees where this is declared

* Applicants from [Least Developed Countries](#) benefit from a 90% reduction in the basic fee

Timeline

The International Trademark Registration Process

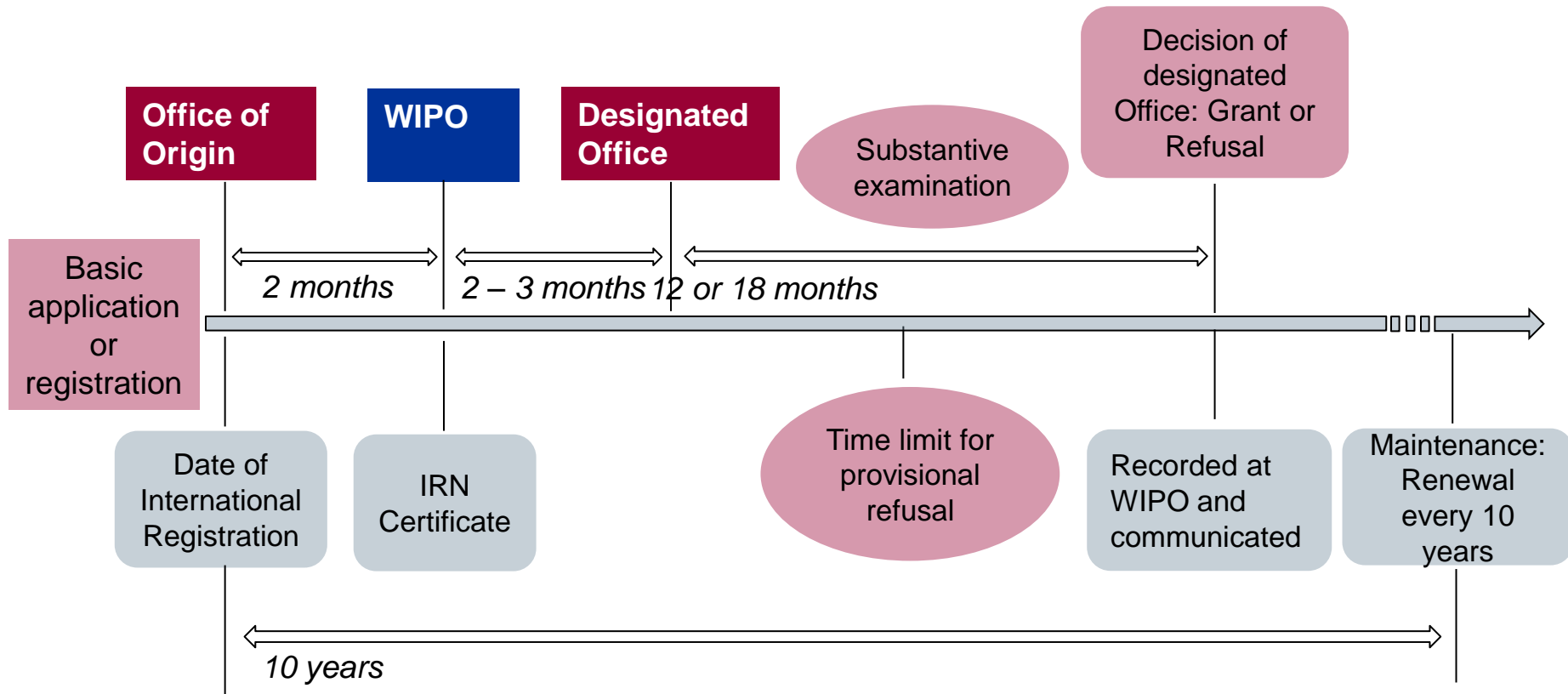

WIPO Resources and E-Services

SEARCH

[Global Brand Database](#) – search marks by text and image from national/international sources, including trademarks, appellations of origin and official emblems

[Member Procedures](#)

FILE

[Forms and E-Forms](#)

[Madrid Goods & Services Manager](#) – correct good & service specifications and translation

[International Application Simulator](#)

[Fee Calculator](#)

[E-Payment](#) – online payment system by credit card/[WIPO current account](#)

MONITOR

[Madrid Monitor \(Beta\)](#) – search and access international registration(IR) information

[ROMARIN](#) – IR database

[Madrid Real-Time Status](#) of international applications and progress of requests

[Madrid Electronic Alert](#) – monitor IR changes

MANAGE

[Madrid Portfolio Manager](#) – access registration documents, uploading of requests for recording, payments

[Forms and E-Forms](#) – [E-Subsequent Designation](#) and [E-Renewal](#)

[Extracts](#) from the International Register

International Applications

Figure A.1.1 Trend in international applications

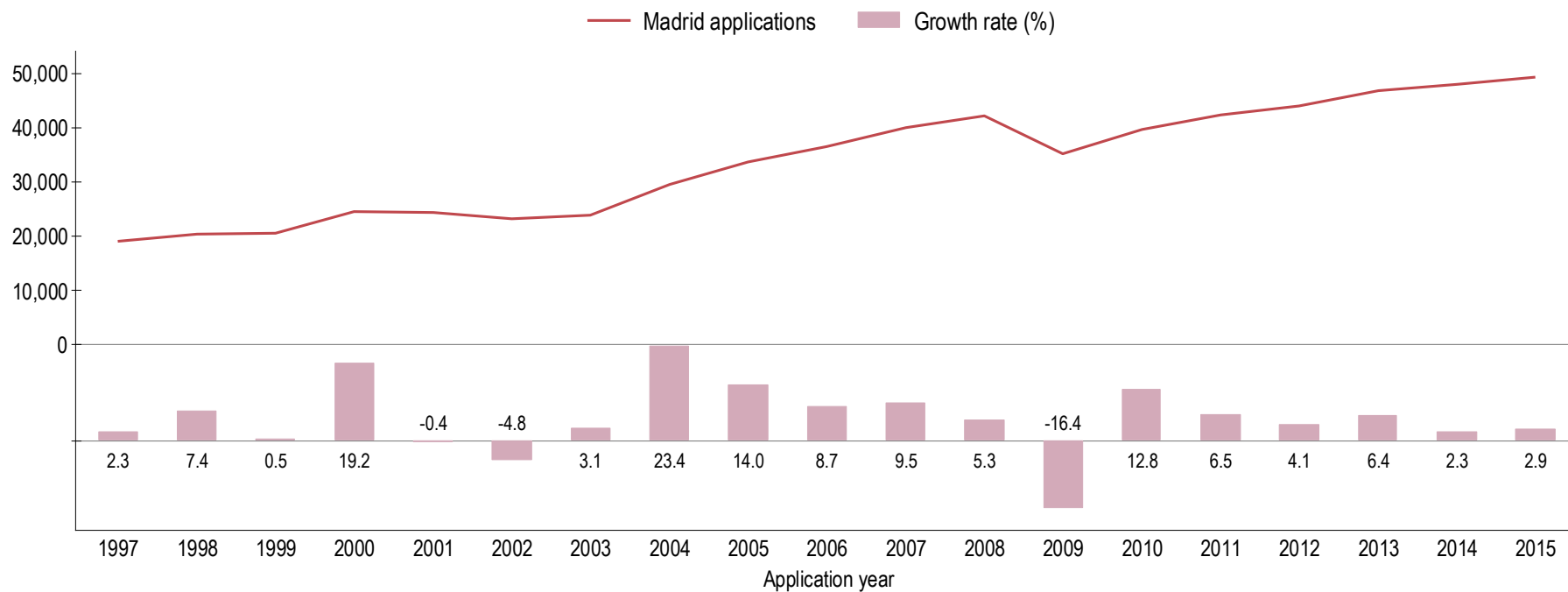

General Profile 2015

51,938 International Registrations

Average Number of Designations	6.75
Average Number of Classes	2.49
Average Fee	CHF 3,102
All Fees	68% < CHF 3,000

Top Filing Contracting Parties

Contracting Parties	2013	2014	2015
United States of America	5,893	5,414	8,486
European Union	6,814	6,996	8,131
Germany	4,357	3,883	4,603
France	3,514	3,377	3,718
Switzerland	2,885	2,994	3,128
Japan	1,855	1,729	2,407
China	2,455	1,738	2,231
Australia	1,195	1,246	2,229
Italy	2,118	2,070	2,165
United Kingdom	1,580	1,560	2,068

Top Designated Contracting Parties

Contracting Parties	2013	2014	2015
China	20,275	20,309	24,849
United States of America	17,322	17,268	21,996
European Union	17,598	17,270	21,721
Russian Federation	18,239	16,573	17,436
Japan	13,179	12,814	15,776
Switzerland	13,215	12,759	14,584
Australia	11,675	11,533	14,292
Republic of Korea	10,967	10,402	12,997
India	1,916	8,138	11,391
Mexico	5,095	8,533	10,569

Top Applicants

#	Name	Origin	Applications
1	NOVARTIS	Switzerland	197
2	LIDL	Germany	152
3	L'ORÉAL	France	130
4	PHILIPS	Netherlands	126
5	RICHTER GEDEON NYRT BOEHRINGER INGELHEIM	Hungary	124
6	PHARMA	Germany	90
7	APPLE	USA	85
8	DAIMLER	Germany	83
9	BIOFARMA	France	81
10	GLAXO GROUP	United Kingdom	68

Recent Developments

- [Madrid Monitor](#) (Beta) – integrates [ROMARIN](#), the [WIPO Gazette](#), [Madrid E-Alert](#) and [Real-time Status](#)
- Madrid E-Filing (Australia and Benelux)
- Algeria's accession to Protocol
 - Madrid operating, for practical purposes, as single-treaty system
 - One form needed for international applications (MM2)
- Decision to Freeze Accessions to Agreement
- Publication of [Madrid System Pendency Rates](#) at WIPO

Short-term Future of the System (2-3yrs)

- Enlarging Membership
 - ASEAN countries - Indonesia, Malaysia and Thailand
 - Canada
 - Caribbean countries – Trinidad and Tobago, and Jamaica
 - African countries – Malawi and South Africa
 - Latin American countries
 - Arab Countries

- Broad-based review of E-Services and development of an online Customer Resources Center
 - Madrid Member Profiles database

Keep Updated on the Madrid System

■ Visit the Madrid Website www.wipon.int/madrid/en

■ Subscribe to [Madrid Notices](#), our regular legal and news updates

■ Sign up for [Madrid Highlights](#), our quarterly newsletter

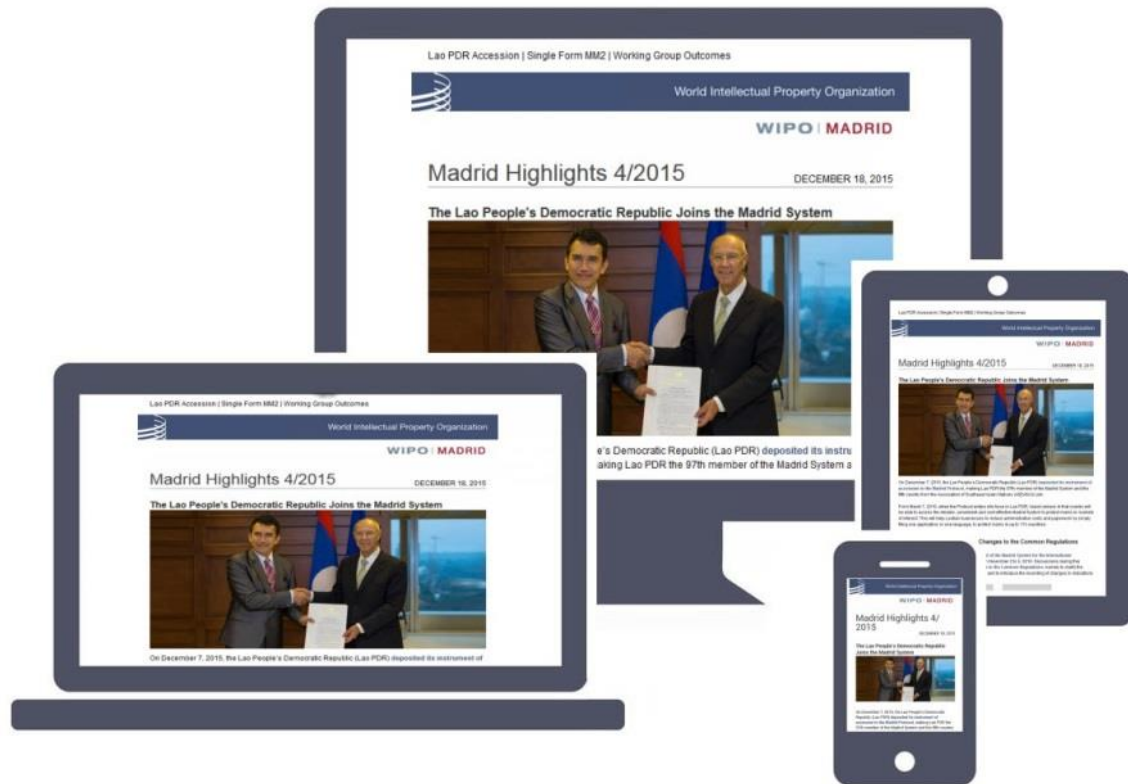

Thank you
for your attention

matthew.forno@wipo.int



The Patent Cooperation Treaty (PCT) Current Status & Recent/Future Developments



Speaker: Matthew Bryan, Director, PCT Legal Division

**San Jose, United States of America
October 31, 2016**

Overview/Current Status

Seeking patents multinationally: traditional patent system vs. PCT system

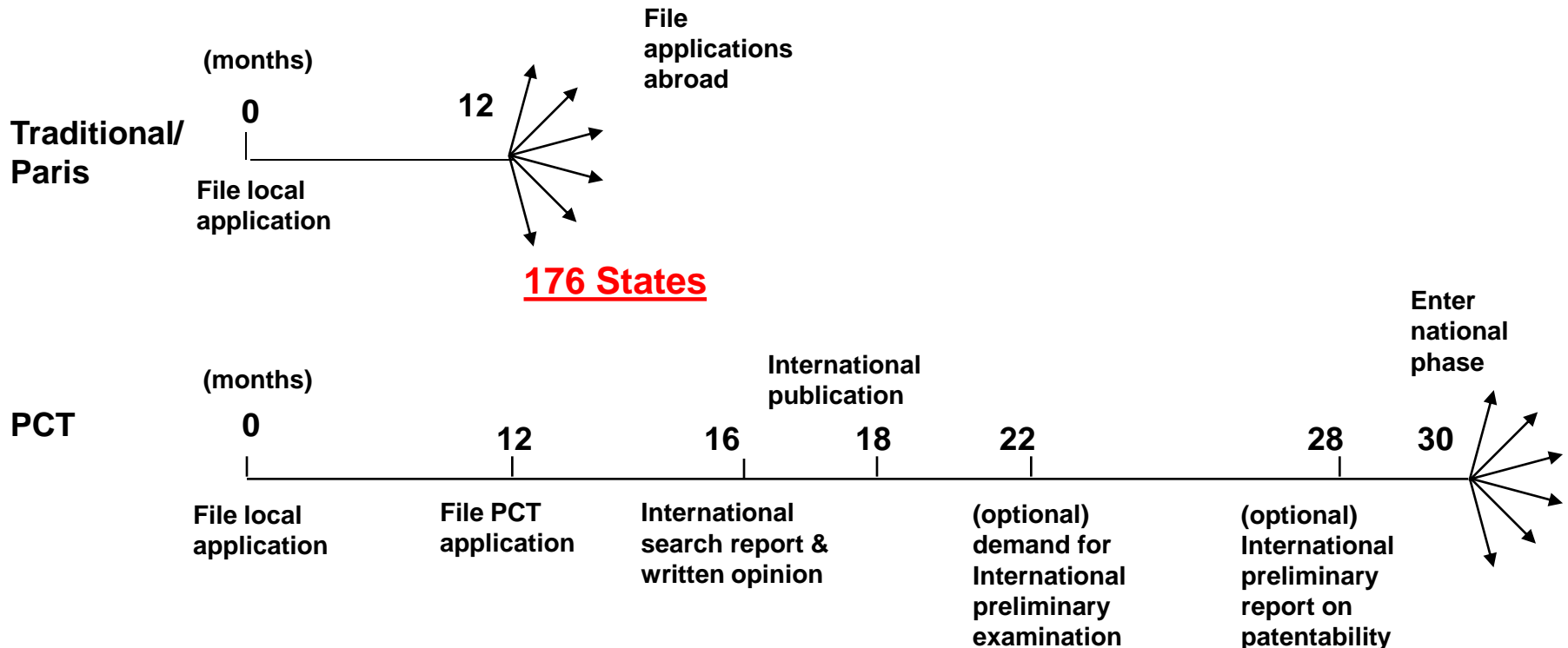

Paris route vs. PCT national phase

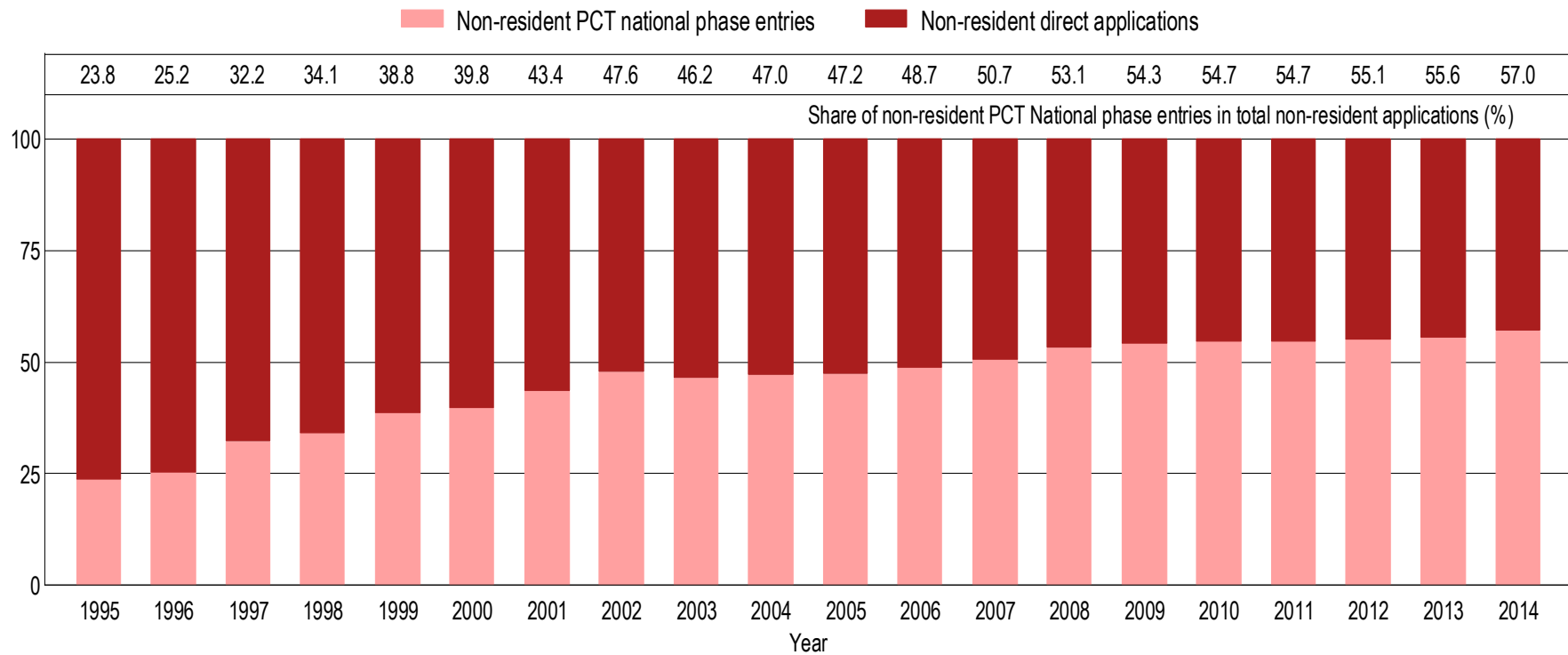

The PCT System

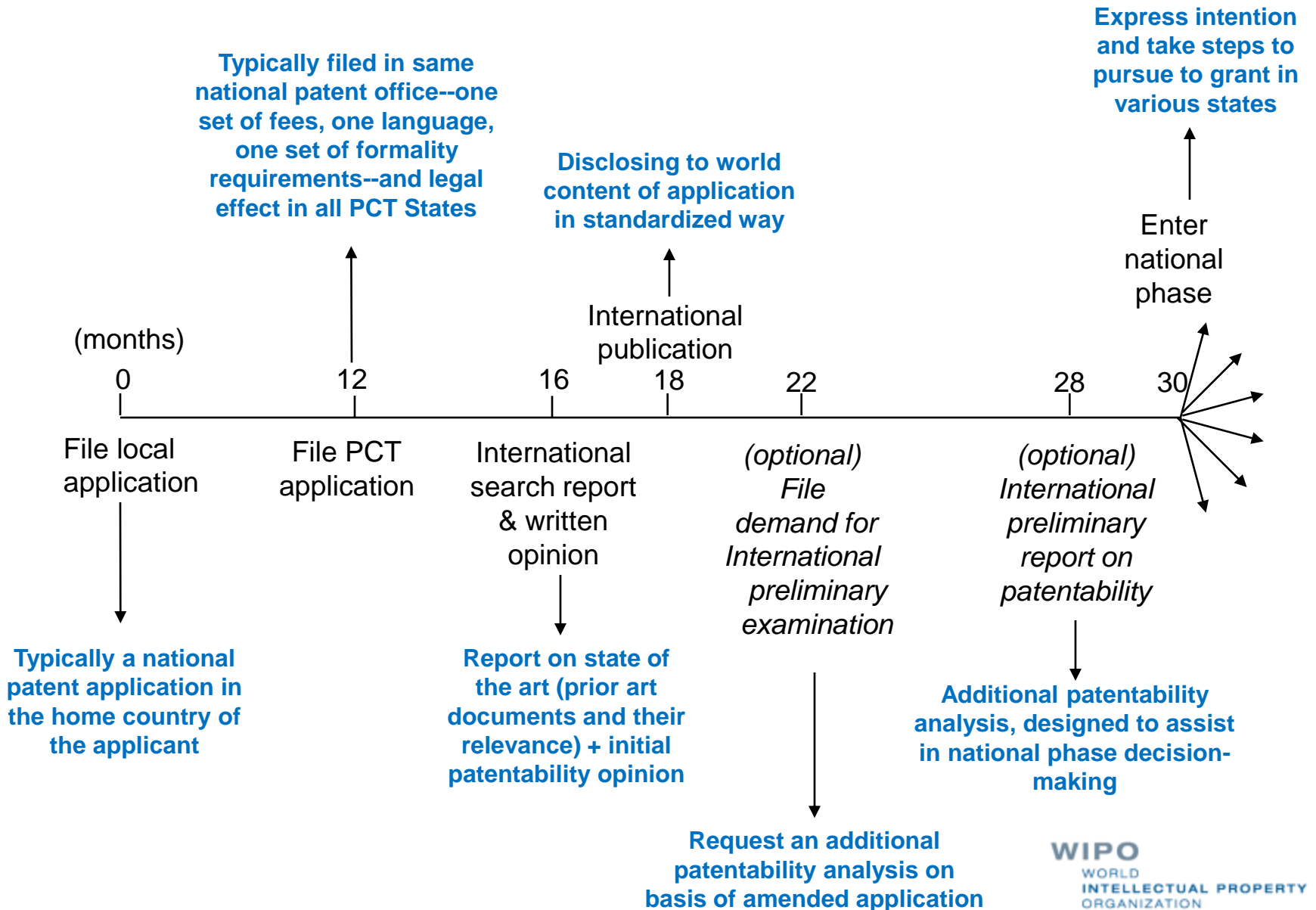

Advantages for PCT Users

The PCT, as the cornerstone of the international patent system, provides a worldwide system for simplified filing and processing of patent applications, which—

1. postpones the major costs associated with internationalizing a patent application
2. provides a strong basis for patenting decisions
3. harmonizes formal requirements
4. protects applicant from certain inadvertent errors
5. evolves to meet user needs
6. is used by the world's major corporations, universities and research institutions when they seek multinational patent protection
7. can result (if PCT reports are positive) in accelerated national phase processing in a number of countries

PCT Testimonial: Start-up

Nokero (produces solar-powered lights which replace kerosene lamps and candles used in developing and least -developed countries--it has so far distributed over 1.4 million lights in 120 countries and won a United States Patent and Trademark Office's Patents for Humanity Award)

“When it comes to patenting, because we operate in so many different markets, we use WIPO’s Patent Cooperation Treaty (PCT). Every start-up has limited funds and the PCT is a great mechanism for delaying patent filing costs, allowing time to test the market and overcome any unforeseen technical problems. Without the PCT, protecting an invention in international markets would be a high-risk strategy with huge upfront costs.”

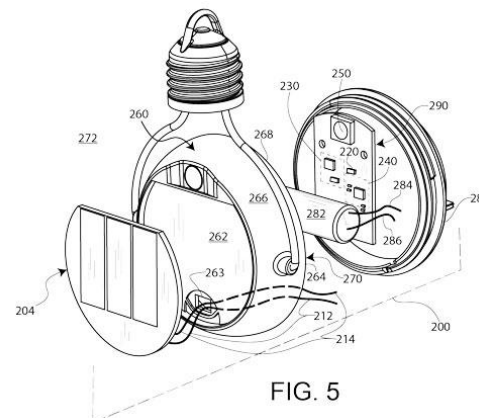

PCT Testimonial: Inventor

Professor Shuji Nakamura—co-winner of the 2014 Nobel Prize for Physics for his work on blue LED technology—is quoted in a December 2014 *WIPO Magazine* article:



“... The PCT is critical for these early stage technologies because it gives us the opportunity to protect our patents globally while allowing the market and the technology to mature further before determining which countries might be most valuable to commercial partners.”

PCT Testimonial: Large Company

Qualcomm:

- Started in 1985 with 7 people
- Today more than 170 offices in more than 40 countries, and 33,000 employees
- \$25.3 billion in revenue in FY 2015
- #2 user of PCT in 2015: 2442 PCT applications published



“Over the past 25 years, Qualcomm has been one of the largest users of the PCT system. To date we have filed more than 9,000 patent applications. International patent applications are important to the protection of innovations around the globe. The PCT helps put innovation into practice by providing a simple and cost-effective way to file international patent applications. The PCT is critical for Qualcomm because we are, above all, an innovation company....[PCT] has been a vital partner in the success of our company and the growth of the wireless industry.” CEO Paul Jacobs, 2011

PCT Coverage Today

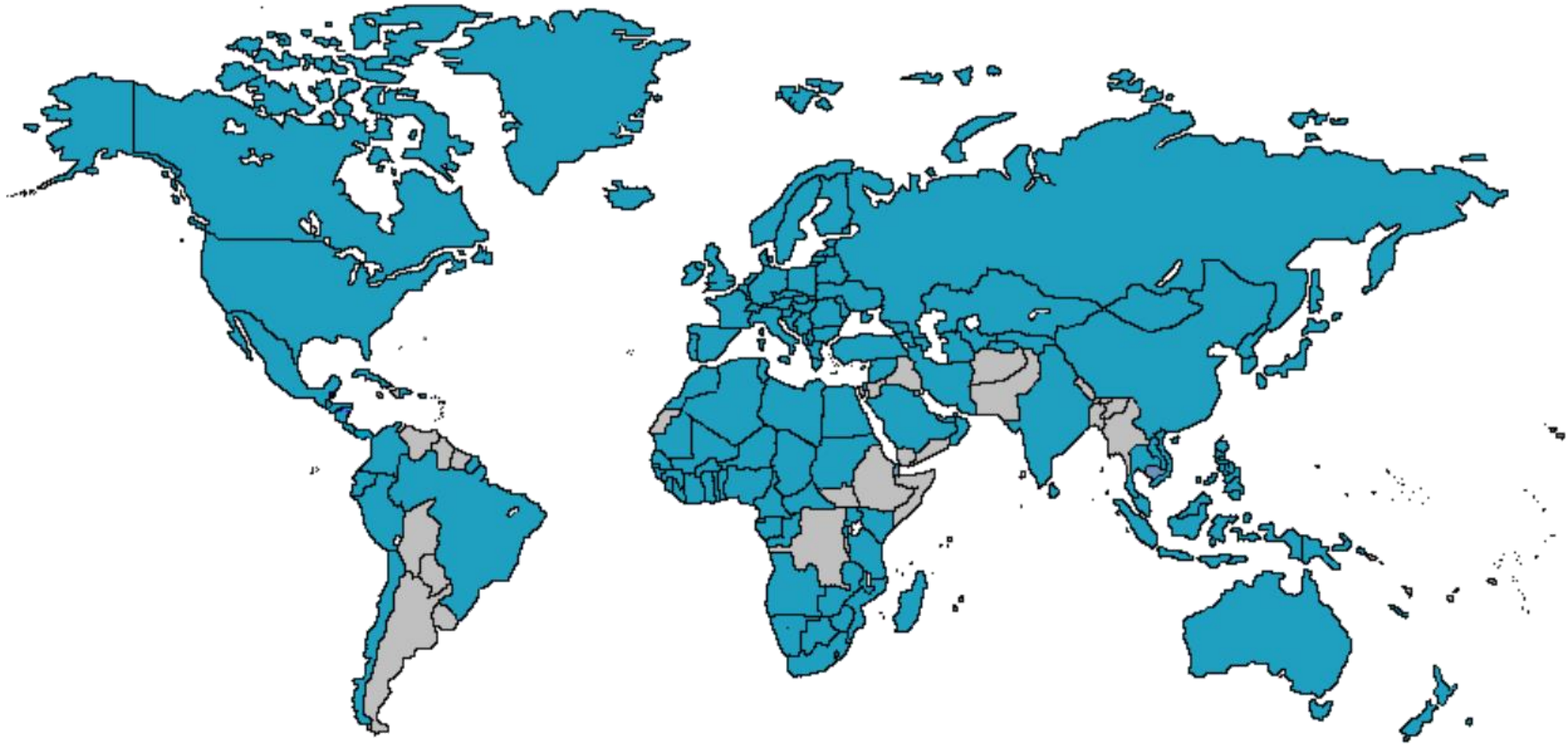

151 PCT States

Recent accessions:

Kuwait
Djibouti
Cambodia

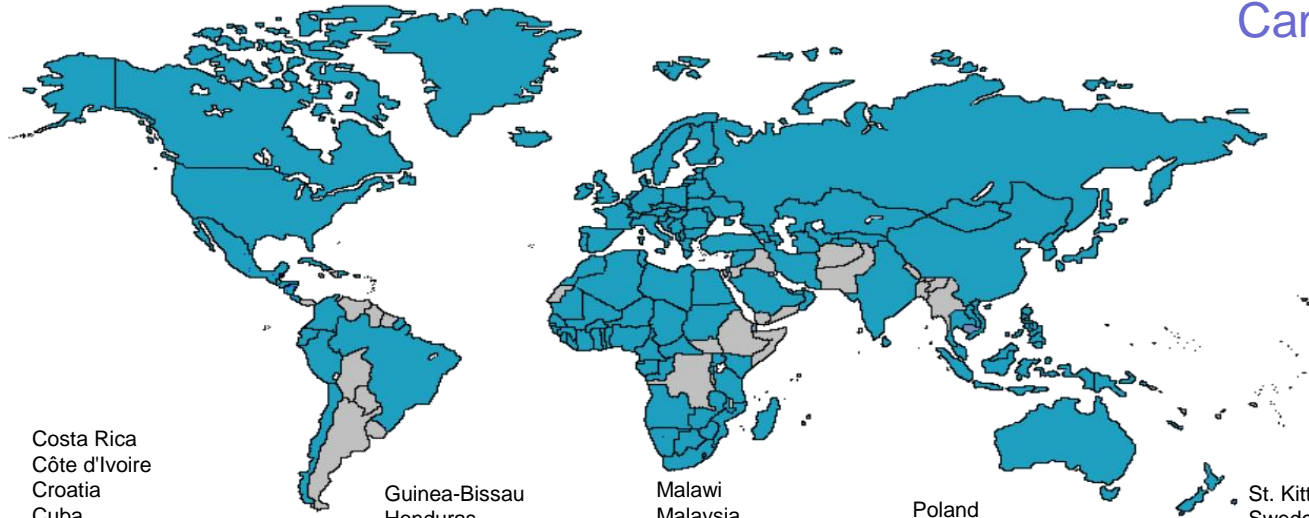

Albania
Algeria
Angola
Antigua and Barbuda
Armenia
Australia
Austria
Azerbaijan
Bahrain
Barbados
Belarus
Belgium
Belize
Benin
Bosnia and Herzegovina
Botswana
Brazil
Brunei Darussalam
Bulgaria
Burkina Faso
Cambodia (8 Dec. '16)
Cameroon
Canada
Central African Republic
Chad
Chile
China
Colombia
Comoros
Congo

Costa Rica
Côte d'Ivoire
Croatia
Cuba
Cyprus
Czech Republic
Democratic People's
Republic of Korea
Denmark
Djibouti (23 Sept. '16)
Dominica
Dominican Republic
Ecuador
Egypt
El Salvador
Equatorial Guinea
Estonia
Finland
France
Gabon
Gambia
Georgia
Germany
Ghana
Greece
Grenada
Guatemala
Guinea

Guinea-Bissau
Honduras
Hungary
Iceland
India
Indonesia
Iran (Islamic Republic of)
Ireland
Israel
Italy
Japan
Kazakhstan
Kenya
Kuwait (9 Sept. '16)
Kyrgyzstan
Lao People's Dem Rep.
Latvia
Lesotho
Liberia
Libyan Arab Jamahiriya
Liechtenstein
Lithuania
Luxembourg
Madagascar

Malawi
Malaysia
Mali
Malta
Mauritania
Mexico
Monaco
Mongolia
Montenegro
Morocco
Mozambique
Namibia
Netherlands
New Zealand
Nicaragua
Niger
Nigeria
Norway
Oman
Panama
Papua New Guinea
Peru
Philippines

Poland
Portugal
Qatar
Republic of Korea
Republic of Moldova
Romania
Rwanda
Russian Federation
Saint Lucia
Saint Vincent and
the Grenadines
San Marino
Sao Tomé e Príncipe
Saudi Arabia
Senegal
Serbia
Seychelles
Sierra Leone
Singapore
Slovakia
Slovenia
South Africa
Spain
Sri Lanka
Sudan
Swaziland

St. Kitts and Nevis
Sweden
Switzerland
Syrian Arab Republic
Tajikistan
Thailand
The former Yugoslav
Republic of Macedonia
Togo
Trinidad and Tobago
Tunisia
Turkey
Turkmenistan
Uganda
Ukraine
United Arab Emirates
United Kingdom
United Republic of Tanzania
United States of America
Uzbekistan
Viet Nam
Zambia
Zimbabwe

UN Member States not yet in PCT

Afghanistan	Jordan*	Timor-Leste
Andorra*	Kiribati	Tonga
Argentina**	Lebanon	Tuvalu
Bahamas	Maldives	Uruguay**
Bangladesh*	Marshall Islands	Vanuatu
Bhutan	Mauritius	Venezuela
Bolivia	Micronesia	Yemen
Burundi	Myanmar	
Cape Verde	Nauru	(42)
Democratic Republic of Congo	Nepal	
Eritrea	Pakistan	
Ethiopia	Palau	
Fiji	Paraguay**	
Guyana	Samoa	
Haiti	Solomon Islands	
Iraq	Somalia	
Jamaica	South Sudan	
	Suriname*	

**preparing to accede*

***PCT discussions ongoing*

International applications received in 2015 by country of origin

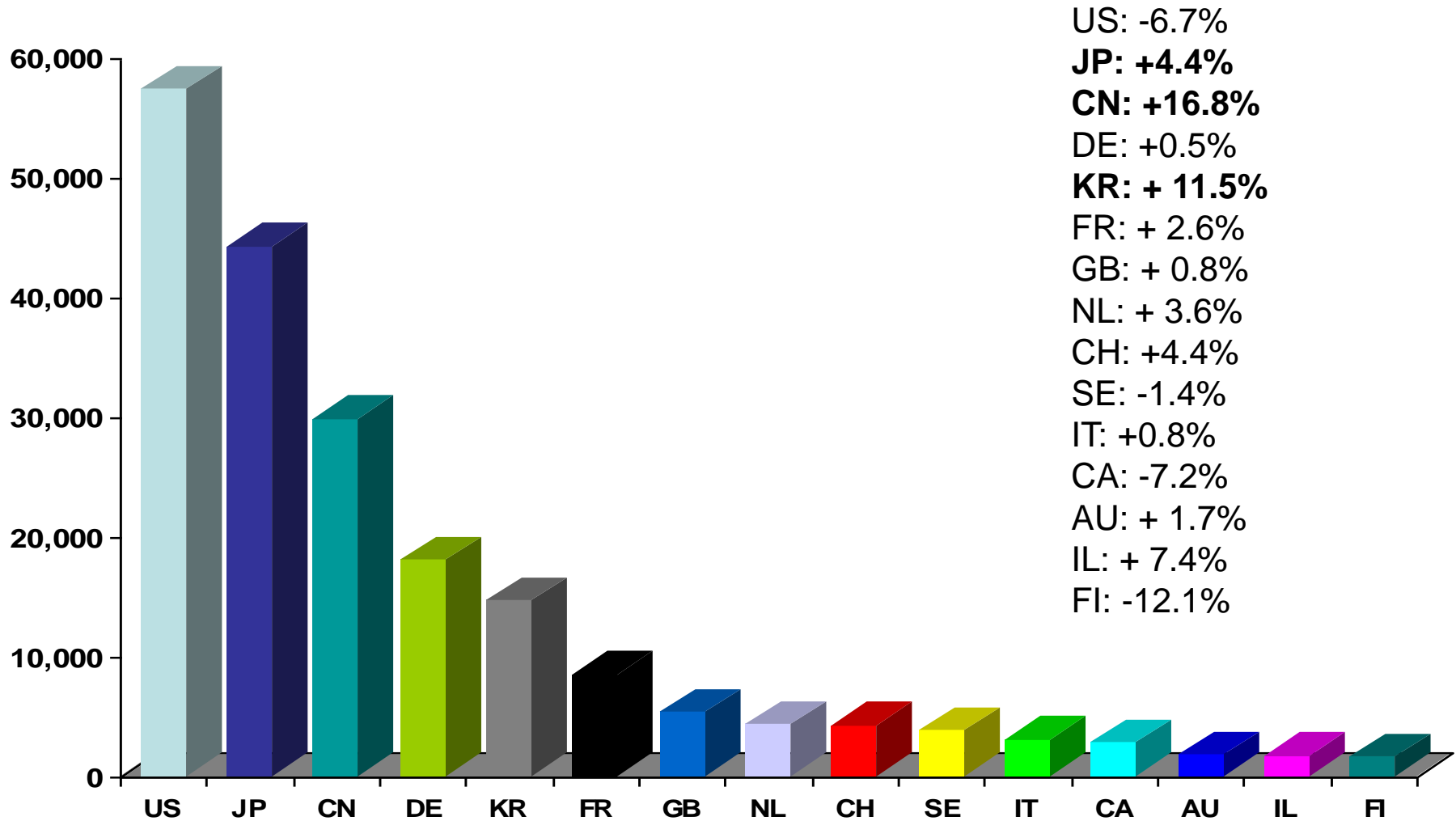

- 26+% originating in US
- 75% from top 5 countries; 92+% of filings from top 15 countries
- PCT applications filed by applicants from 132 countries
- Very close to having 80% of UN member countries in the PCT

PCT use in the US (receiving Office)

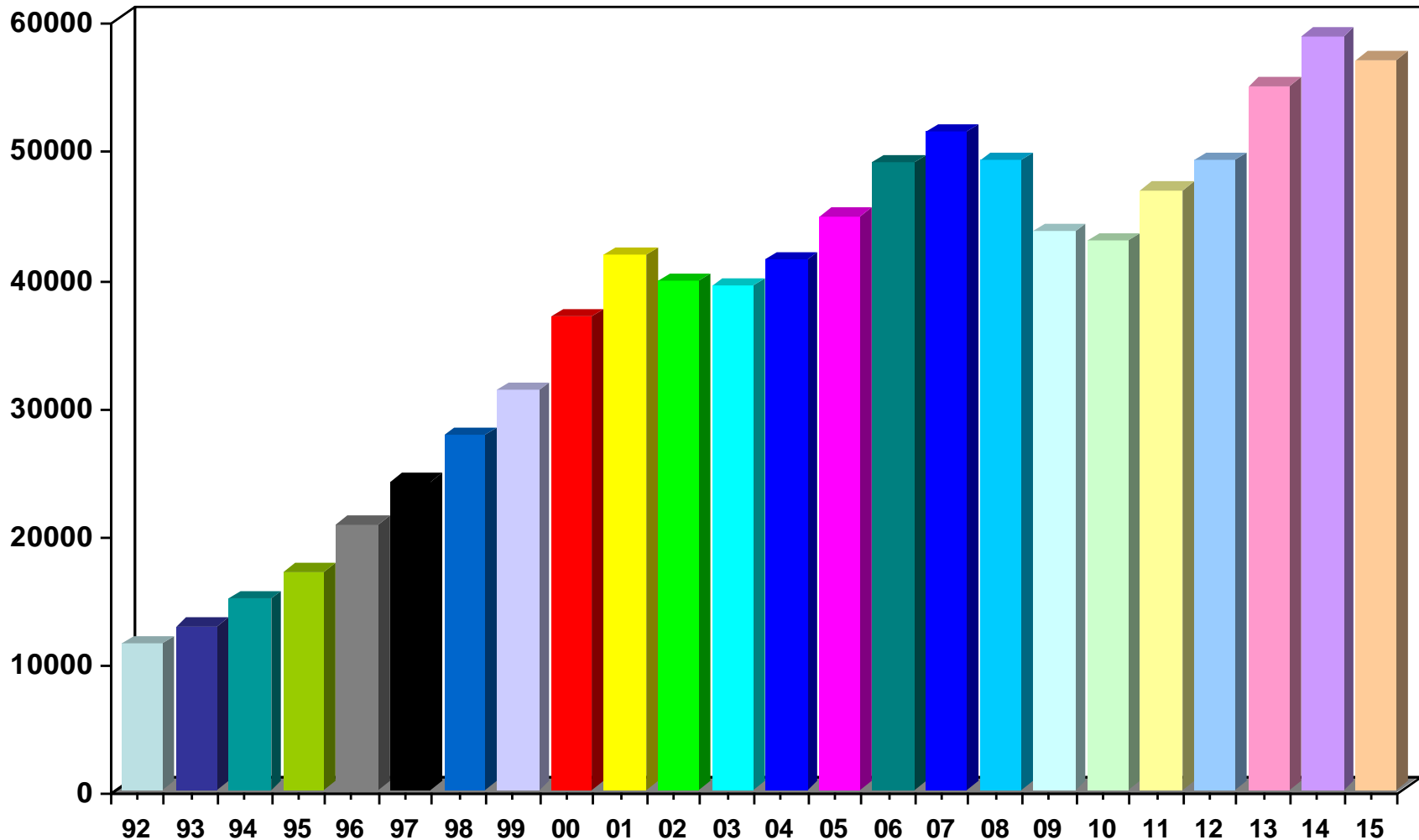

- Joined PCT effective June 1, 1978
- 57,385 PCT applications filed by US applicants in 2015 with RO/US

PCT International Searching Authorities

The appointed ISAs/IPEAs are the following 22 offices:

Australia
Austria
Brazil
Canada
Chile
China
Egypt
European Patent Office
Finland
India
Israel
Japan
Nordic Patent Institute
Republic of Korea
Russian Federation
Singapore
Spain
Sweden
Turkish Patent Institute
Ukraine
United States of America
Visegrad Patent Institute

Recent/Future Developments

July 1, 2016 PCT Rule Amendments (1)

- legal basis and procedure for removing/withholding certain “sensitive information” from public access on applicant’s request (Rules 9, 48 & 94)
 - upon reasoned request by the applicant to the IB
 - Information will be omitted from publication/public file access, if
 - 1) it does not obviously serve the purpose of informing the public about the international application,
 - 2) publication of or public access to such information would clearly prejudice the personal or economic interests of any person, and
 - 3) if there is no prevailing public interest to have access to that information
 - effective as from 1 July 2016 for applications filed on or after that date
- language of communication with IB via ePCT opened to all publication languages (Rule 92)

July 1, 2016 PCT Rule Amendments (2)

- required transmittal by RO to IB of documents submitted in support of requests for restoration of priority right (Rules 26*bis* & 48)
 - Exception: if “sensitive information” standard (Rule 48(I)) met
- “general unavailability of electronic communications services” as grounds for excuse of delay in meeting certain time limits (Rule 82*quater*)
 - Extension of *force majeure* provisions to time limits missed due to “general failures of electronic communication services”
 - PCT Assembly: “covers outages that affect widespread geographical areas or many individuals, as distinct from localized problems associated with a particular building or single user”
 - Amended paragraph 30 of RO Guidelines:
 - Element of “unforeseeable” must be present and no reasonable alternative filing means available
- Effective as from 1 July 2016 for applications filed on or after that date, and for applications filed before that date where the “event” occurred on or after that date

July 1, 2017 PCT Rule Amendments (1)

- transmittal by RO of earlier search and/or classification results to ISA, where national law permits (Rules 12*bis*, 23*bis* & 41))
 - General Rule: ROs forward the search/classification results from applications of which priority is claimed without the applicant's express permission, where permitted by national law
 - Exception:
 - ROs which have notified the IB (before April 14, 2016) of incompatibility of such forwarding with applicable national law are not required to do so
 - USPTO (and 10 other ROs) made this notification
 - Even in cases in which ROs in principle apply the procedure, when filing the PCT application applicants may request to not have the earlier search results forwarded to the ISA (ROs which act in this way are to notify the IB in advance)
- Effective as from 1 July 2017 for applications filed on or after that date

July 1, 2017 PCT Rule Amendments (2)

- designated Offices required to provide IB with timely national phase entry and related data (Rules 86 & 95)
 - Objective: visibility of the status of PCT application during the national phase on PATENTSCOPE under the “National phase” tab
 - Obligation for designated Offices to timely send national phase entry and related data to the IB (within 2 months from expiry of national phase deadline or asap thereafter)
 - Data required to be transmitted:
 - Date national phase entered
 - National application number
 - Number and date of any national publication
 - Number and date of grant
 - Effective as from 1 July 2017 for applications in respect of which the acts referred to in Article 22 or Article 39 are performed on or after that date

PCT Assembly 2016

■ Outcomes

- Appointment of Turkish Patent Institute as PCT ISA/IPEA (#22)
- Amendments to the PCT Regulations (entry into force: 1 July 2017)
 - Modifying time limit to request Supplementary International Search (from 19 to 22 months)
 - Further small change to Rule 23*bis*
 - Removal of unnecessary incompatibility provisions

PCT Working Group 2016 (1)

■ Outcomes:

- Report provided on upcoming 3rd pilot of IP5 collaborative search and examination
 - Planned that all IP5 offices will participate, will be applicant driven (to assess business interest), will involve at least 100 PCT applications per office and last up to 3 years, so as to fully assess impact
- IB will consult with Offices and user groups on:
 - proposed pilot for ePCT national phase entry functionality
 - technical/legal/administrative issues related to color drawings
 - translation difficulties relating to the number of words in abstracts and drawings
 - inclusion of CPC/other national classification symbols on front page of published international applications
- Examiner training
 - IB will:
 - compile info on examiner training provided by offices
 - invite offices to provide training to examiners from other offices
 - develop concept for improved coordination of examiner training
 - invite sharing of training materials

PCT Working Group 2016 (2)

- Outcomes (cont.):
 - No agreement on proposals concerning:
 - same day priority claims
 - missing parts/erroneously filed procedure
 - fee reductions proposed by Brazil for universities and public research organizations—for further discussion next year
 - proposed amendments to Schedule of Fees and Rule 92*bis* to assist IB in responding to potentially abusive use of PCT fee reductions

Other practice changes

- Payment by cheque to the IB no longer accepted
 - Following the introduction of further restrictions with regard to the processing of cheques by the International Bureau's banking partners, **the International Bureau will no longer accept payment by cheque with effect from January 1, 2017.**
 - Any cheque received on or after this date will be systematically returned to the issuer

The PCT—1978 to 2016 (1)

- As filing tool: PCT has been extremely successful
 - preferred route for international patenting (\approx 218,000 applications in 2015, > 57% “market share”)
 - harmonization of formal and procedural requirements, beyond PCT
 - national laws; Patent Law Treaty (PLT)

The PCT—1978 to 2016 (2)

- As worksharing tool: (which it was intended by its founders to be), PCT has not been as effective in practice
 - had it been successful up to now in this sense, it would have been of more assistance in addressing national quality of examination and (for some Offices) backlogs in processing
 - expectation by founders was: “flying start” for offices, which would complete, further check, and criticize ...
 - reality: many Offices start “from scratch”, perhaps not in complete isolation, but to a great degree ...
- What is needed: build more trust between patent offices, so that duplicative international phase and national phase processing can be reduced

Continued areas of PCT focus (1)

■ Quality:

- Improve the quality and consistency of PCT international phase reports
- Develop quality metrics for measuring usefulness of international phase reports
- Develop quality feedback system for offices (e.g., DO to ISA)
- Explore collaborative search and examination
- Improve timeliness of PCT work

■ Help designated Offices to better understand reports

- Search strategies, standardized clauses, explanations of relevance of cited documents, etc.

■ Improve timeliness of actions in international phase

- ISAs/IPEAs, ROs (eSearchCopy)

■ Improve access to national search and examination reports

- PATENTSCOPE, WIPO-CASE, Global Dossier

■ Make progress against misleading invitations sent to PCT users



INVOICE



Amount : USD 1588,00
 Date :
 Reference Number :

Classification International :

Publication No :

Publication Date :

Application No :

Filing Date :

Title:

Please transfer the amount to the bank account mentioned below within 8 days.

Charges of registration	USD 1588,00
Extra charges	USD 0,00
Total amount	USD 1588,00

Attention: it is important that you always quote the Reference number 00211977 / 2016

Payment by Wire Transfer

Beneficiary: IIP International Intellectual Property
 IBAN: ES34 2100 6807 8501 0011 1948
 BIC: CAIXESBBXXX

Above mentioned the publication number, publication date, international application number, international filing date, priority date, title and reference number. You confirm this offer by remitting the following amount and in doing so, you confirm that the wording of the entry entered by ourselves and rendered here is correct. This is not a bill this is a solicitation. You are under no obligation to pay the amount stated underneath unless you accept this offer. Any requests for amendments and additions are to be made in writing.

IIP International Intellectual Property Office Patent & Trademark Center - 5th Floor 100 Larkin St. San Francisco, CA 94102 USA
 Phone +14158547431 Fax +14159602649
 IIP Intellectual Property Office Calle Guabairo 20 - 3.I E- 28047 MADRID Phone +34 656692945
 IIP International Intellectual Property Office PENHURST HOUSE 352-356 BATTERSEA PARK ROAD LONDON SW11 3BY ENGLAND



• Int Class:

• Title:

• Payment Details:

Subject	Amount
Filing Fee for Order 1160500654	1.829,00 EUR
Processing Fee	25,00 EUR
Additional Fee	0,00 EUR
Total Filing Fee	1.854,00 EUR

Please pay the Amount, within 14 days. Don't forget to quote the Order Number: **1160500654**



• Registration of the International Patent:

The international patent has been published in the WIPO-Gazette, which is edited by Bureau of the World Intellectual Property Organization. This publishing forms the basis of our offer. Please note, registration is not affiliated with the publication of the official International Patent Application registration and is not a registration by a government entity. This form is solely the offer for the concluding of the contract, being the year registration of your international patent application in our internet database and access to all database services. Applicant in the sense of the provision § 1744 law no. 89/2012 Coll., Civil Code, accepts this motion of Provider to the concluding of the contractual relationship by the execution of the non-cash settlement of the annual registration price to the account of Provider. To access the database, identify the offer number. By the settlement of the price Applicant agrees that the contractual relationship shall be governed by the company general terms of business, specified on the second page of this application; the issues not modified by these terms shall be governed by the law no. 89/2012 Coll., Civil Code. By the acceptance of this motion Applicant hereby declares to familiarize himself with the General Terms of Business and to read them; furthermore, he declares to agree with their wording. Due to legal reasons, all and any back-payment claims and complaints filed directly or via the bank, will neither be processed or accepted by us. The bank cannot refund you without our approval. Please save our as well as your precious time and choose the shortest way for a settling of your complaint and approach us directly at cancel@ipti.biz.

IPTI s.r.o., Olišanská 54/3, Žižkov, 130 00 Praha 3, Czech Republic, Tax number: 04564804, www.ipti.biz

452BD5AE

• International Application No:

• Publication Number:

• Publication Date:

• International Filing Date:

• Order Number: • Sent Date:



INVOICE



Amount : EUR 1477,00
Date : 2015-12-11
Reference Number : 0291977 / 2015

Classification International :

Title:

Publication No :
Publication Date :
Application No :
Filing Date :

Please transfer the amount to the bank account mentioned below within 8 days

Charges of registration	EUR 1477,00
Extra charges	EUR 0,00
Total amount	EUR 1477,00

Attention: it is important that you always quote the Reference number 0291977 / 2015

Payment by Wire Transfer:

Beneficiary: WIPD International Intellectual Property Office
IBAN:ES34 2100 6807 8501 0011 1948
BIC: CAIXESBBXXX

Above mentioned the publication number, publication date, International application number, International Filing Date, priority date, Title and reference number. You confirm this offer by remitting the following amount and in doing so, you confirm that the wording of the entry entered by ourselves and rendered here is correct. This is not a bill this is a solicitation. You are under no obligation to pay the amount stated underneath unless you accept this offer. Any requests for amendments and additions are to be made in writing.

WIPD International Intellectual Property Office Patent & Trademark Center - 5th Floor 100 Larkin St. San Francisco, CA 94102 USA
Phone +14158547431 Fax +14159063649
WIPD Intellectual Property Office Calle Guabairo 20 - 3.1 E- 28047 MADRID Phone +34 655692945
MADRID SAN FRANCISCO
Email: registerofficeusa@gmail.com www.stpi.org www.inta.org www.registertrademarks.net



REG: INTERNATIONAL PATENT APPLICATION
PUBLICATION NUMBER:



INVOICE

DATE:

INVOICE/ACCOUNT NUMBER:
597047

APPLICATION REGISTRATION/PUBLICATION FEE:
1.998,80 €

PAYMENT TERMS:
APPLICATION REGISTRATION/PUBLICATION FEE
NEEDS TO BE PAID **WITHIN 8 DAYS** OF RECEIPT
OF PAYMENT NOTIFICATION

PAYMENT DETAILS:
BENEFICIARY: WIPO-WORLD INTELLIGENT
PROPERTY OFFICE

BANK: RAIFFEISENBANK
ACCOUNT: 1610000121500271
IBAN: BA391610000121500271
SWIFT/BIC: RZBABA2S

Priority Data:

International Application No.:

IMPORTANT: UPON PAYMENT RECEIPT IN THE AMOUNT OF EUR 1.998,80
BY THIS OFFICE, APPLICATION PROCESSING WILL COMMENCE
APPLICATION REGISTRATION/PUBLICATION OF YOUR INTERN. PATENT APPLICATION;
Below find summarization of published Intern. Patent Application in the WIPO Patentscope Gazette

Title:

Publication Date: Publication Number: International Filing Date:

IMPORTANT: APPLICATION REGISTRATION/PUBLICATION FEE IN THE AMOUNT OF **EUR 1.998,80** NEEDS TO BE
PAID **WITHIN 8 DAYS** OF RECEIPT OF PAYMENT NOTIFICATION FOR APPLICATION PROCESSING

INVOICE/ACCOUNT NUMBER : 597047			
ITEM	DESCRIPTION	CURRENCY	AMOUNT
001	APPLICATION REGISTRATION/PUBLICATION FEE INTL. PATENT APPLICATION INTL. APPLICATION NUMBER: PUBLICATION DATE:	EUR	1.998,80
002	PROCESSING FEE	EUR	0,00
	USE BELOW DETAILS FOR PAYMENT: BENEFICIARY: WIPO-WORLD INTELLIGENT PROPERTY OFFICE BANK: RAIFFEISENBANK ACCOUNT: 1610000121500271 IBAN: BA391610000121500271 SWIFT/BIC: RZBABA2S		
	SUBTOTAL	EUR	1.998,80
	TRANSFER FEE	EUR	0,00
	ADDITIONAL PUBLICATION FEE	EUR	0,00
	INVOICE TOTAL	EUR	1.998,80

WE REMIND YOU THAT THE INVOICE/ACCOUNT NUMBER MUST BE CLEARLY IDENTIFIED IN THE
BANK TRANSFER ORDER

THE APPLICATION REGISTRATION AND PUBLICATION FEE IN THE AMOUNT OF **EUR 1.998,80** HAS TO BE
CREDITED **WITHIN 8 DAYS** OF THIS NOTIFICATION TO: WIPO-WORLD INTELLIGENT PROPERTY OFFICE

WIPO-World Intellectual Property Office, 32 chemin des Colombettes, CH-1211 Geneva 20, Switzerland
www.wipo.int / Email: invoice@wipo.int

WARNING: Requests for Payment of Fees

It has come to the attention of the International Bureau that PCT applicants and agents are receiving invitations to pay fees that do not come from the International Bureau of WIPO and are unrelated to the processing of international applications under the PCT. Whatever registration services might be offered in such invitations, they bear no connection to WIPO or to any of its official publications.

PCT applicants and agents should note that it is the International Bureau of WIPO alone which publishes all PCT applications promptly after the expiration of 18 months from the priority date (see PCT Article 21(2)(a)); there is no separate fee for such international publication, and the legal effects of international publication are set out in PCT Article 29.

The invitations often identify a particular PCT application by its international publication number (eg: WO 02 xxxxxx), publication date, title of the invention, international application number, priority information and IPC symbols; examples of such invitations can be viewed below.

IIP – International Intellectual Property Office

Published on February 22, 2016

IPTI – International Patents & Trademark Index

Invitation not listed here? E-mail us a copy

- [Trademarks \(Madrid System\)](#)
- [Patents \(PCT System\)](#)

Mitigating this unscrupulous practice

- WIPO invites its customers to use and adapt this standard text to notify applicants and inventors about such fee requests. [\[WORD\]](#)
- Circular letter addressed by WIPO Director General, Francis Gurry to all PCT Contracting States and Regional Organizations. [PDF](#)

How to make a complaint? 

Continued areas of PCT focus (2)

- Helping developing countries benefit from the PCT
 - top 15 countries responsible for 92% of IAs filed in 2015
 - improve training for patent examiners (especially in developing and least developed countries), and better coordinate training already provided
- Making PCT accessible to applicants of all types from all Contracting States
 - fee reductions (SMEs, universities, research institutes, individual applicants)

Continued areas of PCT focus (3)

- ePCT: electronic interface to entire PCT international phase process
 - real time access to IB files and bibliographic data
 - notifications of significant events and approaching deadlines
 - Online electronic preparation and filing with real-time validations (currently with 43 receiving offices, including IB, Algeria, Austria, Australia, Azerbaijan, Brazil, Brunei, Bulgaria, Canada, Chile, Colombia, Cuba, Czech Republic, Denmark, EAPO, Estonia, EPO, Finland, Hungary, Iceland, India, Indonesia, Israel, Iran, Latvia, Malaysia, Mexico, New Zealand, Norway, Oman, Philippines, Poland, Portugal, Qatar, Republic of Korea, Russian Federation, Saudi Arabia, Slovakia, Sweden, Singapore, Turkey, South Africa, and the United States of America)
 - Multilingual (10 language) interface available
 - Working on centralized fee payment mechanisms
 - US PCT users filing with ROUS can now (as of 1 June 2016) use ePCT to prepare their PCT application and upload the resulting .zip file in EFSWeb, but....
 - care should be taken to ensure that the technical data loaded into ePCT is not subject to export controls
 - Consulting on how ePCT could be used for national phase entry

The PCT of the Future

- Should include: (*in the view of the IB*)
 - Renewed emphasis of the “Cooperation” element in PCT:
 - Offices and Authorities performing their roles in a timely way and to the level of quality necessary to allow other Offices and the public at large to trust in the work performed by them
 - Increase the capacity to measure that quality
 - Full faith and credit should be given to an Office’s own ISA workproduct
 - Further consider allowing the market/competition (e.g., greater ISA choice for applicants) to exert an effect
 - Make use of DO feedback, as particularly interested consumers of PCT reports
 - Development of IT systems and standards to support sharing information with other Offices more effectively
 - Centralized fee payment mechanism?
 - Establishment of appropriate applicant incentives so that they play a more effective part in the cooperation
 - Provision of training and assistance to Offices from all Contracting States so that they are able to perform their roles effectively

Reminders

- The PCT contains useful mechanisms, such as:
 - Third party observations
 - Restoration of priority procedures
 - A way to draw attention to individual applications by including licensing-related information
 - Being able to request excuse of delay in meeting national phase entry deadline
- Always:
 - View and review filed application online asap after filing
 - Review published application immediately after publication
 - Respect national phase entry time limit
 - Request RO to prepare and transmit priority document
 - Consider submitting any restoration of priority requests to RO/IB
 - File 92*bis* requests only with IB directly
 - Call/email when you have a doubt or question
- Never:
 - Submit a notice of withdrawal to the RO or any authority other than the IB

PCT Information and Training

- 29 video segments on WIPO's Youtube channel and WIPO's PCT page about individual PCT topics
- PCT Distance learning course content available in the 10 PCT publication languages, and a 2nd detailed PCT DL course under preparation
- PCT Webinars
 - free updates on developments in PCT procedures, and PCT strategies—previous webinars are archived and freely available
 - upon request also for companies or law firms, for example, for focused training on how to use ePCT
- Videoconference and audio possibilities also available
- In-person PCT Seminars and training sessions: see PCT seminar calendar (<http://www.wipo.int/pct/en/seminar/seminar.pdf>)
- Monthly Newsletter (<http://www.wipo.int/pct/en/newslett/>)
- Extensive information resources on PCT website (<http://www.wipo.int/pct/en/>)

PCT Resources/Information

For general questions about the PCT, contact the PCT Information Service at:

Telephone: (+41-22) 338 83 38

Facsimile: (+41-22) 338 83 39

E-mail: pct.infoline@wipo.int

matthew.bryan@wipo.int

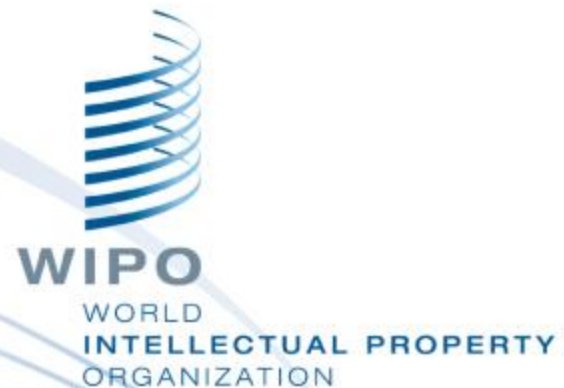

The International Registration of Industrial Designs, Using the Hague System

Roving Seminar on WIPO Services and Initiatives

Matthew Forno
Senior Counsellor
Information and Promotion Division
Brands and Designs Sector, WIPO

**San Jose, United States of America
October 31, 2016**

What is the Hague System?

- A one-stop shop to obtain and maintain industrial design protection in export markets
- A closed system and an option to the national route
- A purely procedural treaty
- The domestic legislation of the designated Contracting Parties set the conditions for protecting industrial designs and determine the rights which result from protection

Paris Route vs. Hague Route

Direct/Paris Route

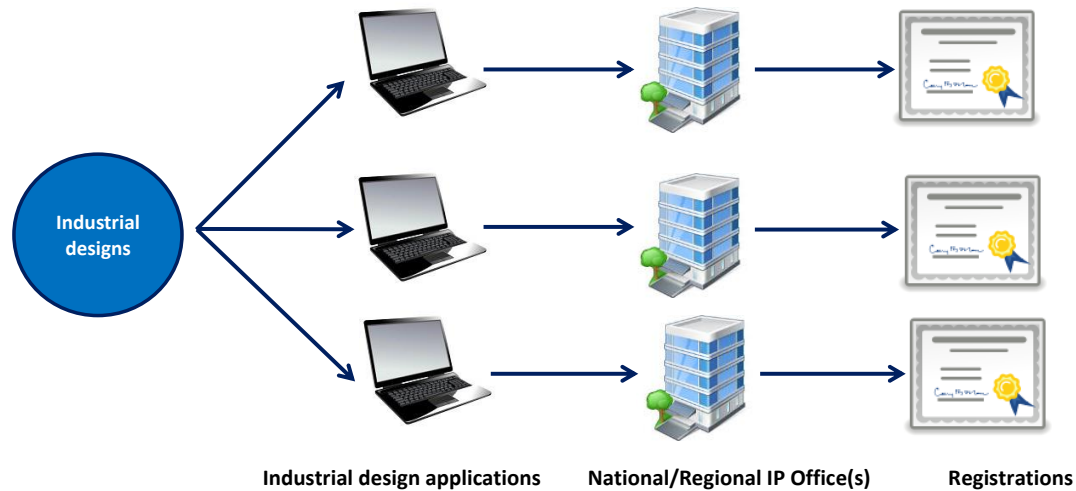

The Hague System



Key Features of the Hague System

- Entitlement, but no basic design
- Direct filing with the International Bureau of WIPO
- One application – one language – one set of fees
- One registration covering multiple territories
- «Self-designation» is possible
- Possible deferment
- Fixed time limit for refusal – 6 or 12 months
- Renewal – every 5 years – 15 years for the 1999 Act
- Centralized management of portfolio

Hague Union: Going Global

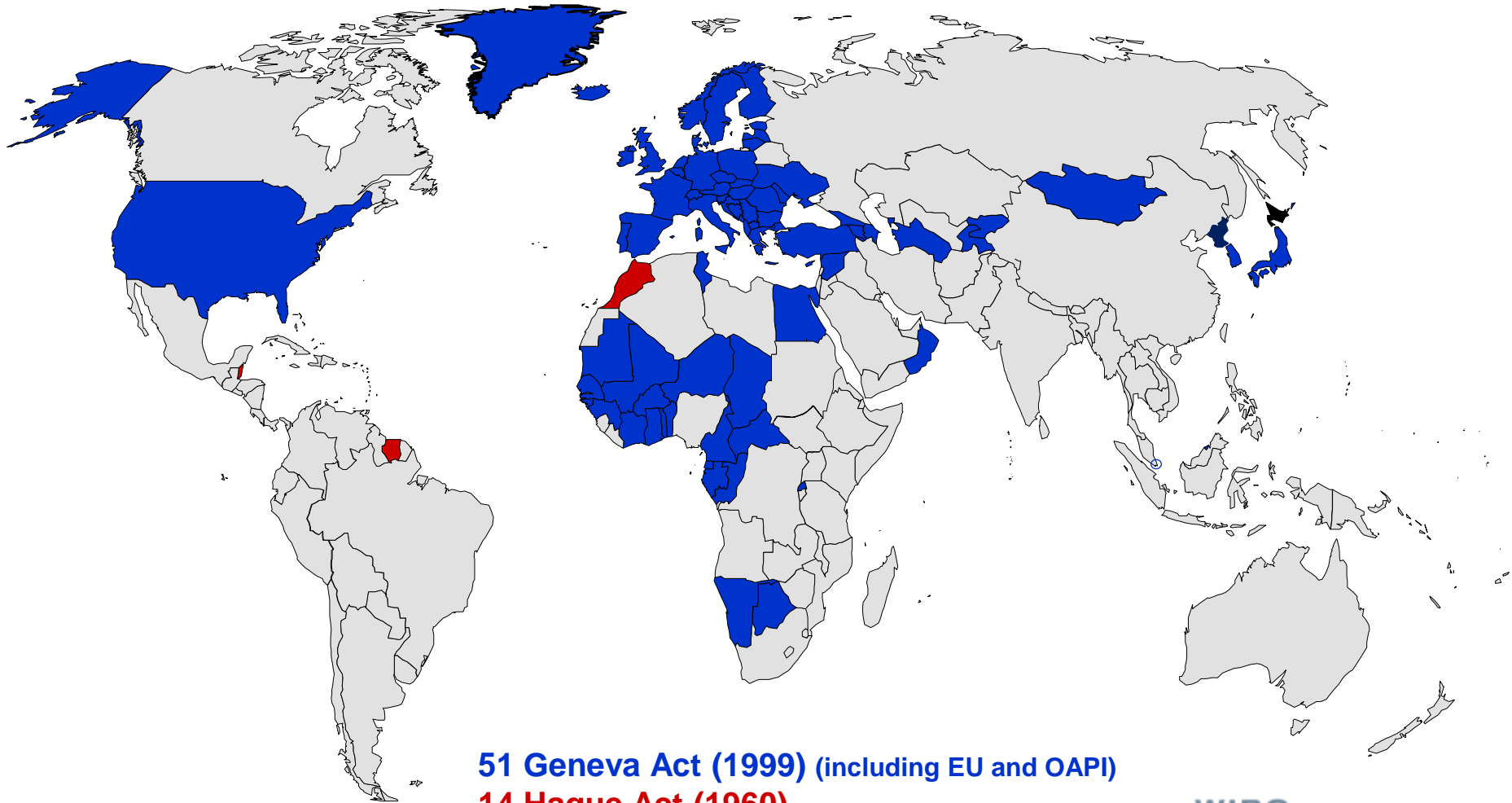

51 Geneva Act (1999) (including EU and OAPI)

14 Hague Act (1960)

65 Contracting Parties

Hague Union Members according to the most recent applicable Act

Geneva Act (1999)

•African Intellectual Property Organization, Albania, Armenia, Azerbaijan, Bosnia and Herzegovina, Botswana, Brunei Darussalam, Bulgaria, Croatia, D.P.R. of Korea, Denmark, Egypt, Estonia, European Union, Finland, France, Georgia, Germany, Ghana, Hungary, Iceland, Japan, Kyrgyzstan, Latvia, Liechtenstein, Lithuania, Monaco, Mongolia, Montenegro, Namibia, Norway, Oman, Poland, Republic of Korea, Republic of Moldova, Romania, Rwanda, Sao Tome and Principe, Serbia, Singapore, Slovenia, Spain, Syrian Arab Republic, Switzerland, Tajikistan, the former Y.R. of Macedonia, Tunisia, Turkey, Turkmenistan, Ukraine and the United States of America (51)

Hague Act (1960)

•Belgium, Belize, Benin, Côte d'Ivoire, Gabon, Greece, Italy, Luxembourg, Mali, Morocco, Netherlands, Niger, Senegal and Suriname (14)

Potential Accessions

-  China
-  Russian Federation
-  Morocco
-  ASEAN countries
-  Israel
-  Canada
-  United Kingdom
-  Mexico
-  Madagascar

Trends: Continuing Growth



■ 2015:

- 3,581 international registrations contained 14,484 designs;
- Growth (%) 2014-2015: +32.5% registrations, +7.3% designs

■ 2016 (until September 30):

- 3,892 international registrations contained 13,456 designs
- Growth (%) to same period in 2015: +62.9% registrations, +32 % designs

Trends: 2016 (until September 30):

TOP 10 Designations (designs recorded by Designated Contracting Party)

		Growth
European Union	10615	+23%
Switzerland	6348	-2%
Turkey	4613	+10%
United States of America	3181	+422%
Norway	2339	-4%
Singapore	2131	+4%
Ukraine	2105	+2%
Republic of Korea	1901	+20%
Japan	1695	+376%
Morocco	1432	-4%

Trends: 2016 (until September 30):

TOP 10 origins (designs registered by country of address of the holder)

		Growth
Germany	2712	20%
Switzerland	1939	-21%
Republic of Korea	1480	+87%
United States of America	1009	+160%
Netherlands	971	+120%
France	968	+11%
Italy	869	+15%
Japan	592	+498%
Turkey	380	+98%
Denmark	300	+261%

Trends: 2016 (until September 30): TOP 10 applicants by designs

	Count	Applications	Designs
Fonkel Meubelmarketing	NL	25	709
SAMSUNG ELECTRONICS CO., LTD.	KR	253	700
LG ELECTRONICS INC.	KR	516	551
RENAULT s.a.s.	FR	43	289
Volkswagen Aktiengesellschaft	DE	56	277
SWATCH AG (SWATCH SA) (SWATCH LTD.)	CH	82	255
The Procter & Gamble Company	US	50	241
Microsoft Corporation	US	25	187
Wenko-Wenselaar GmbH & Co. KG	DE	16	180
HERMES SELLIER	FR	20	142

Two Filing Options for US Applicants

INDIRECT:

WIPO Paper Form *via* EFS Web

- Familiar environment
- USPTO's Quick Guide
- Integrated Export License
Process
- Transmittal Fee

DIRECT:

WIPO E-filing Interface

- Dedicated electronic tool
- Easier than using paper form
- Embedded alerts and guidance
 - Integrated fee calculator
 - No additional fees
 - No intermediary
- Workbench / Re-use functions
- Online correction of irregularities

US Filings* (as received at the IB May 2015 up to September 30, 2016)

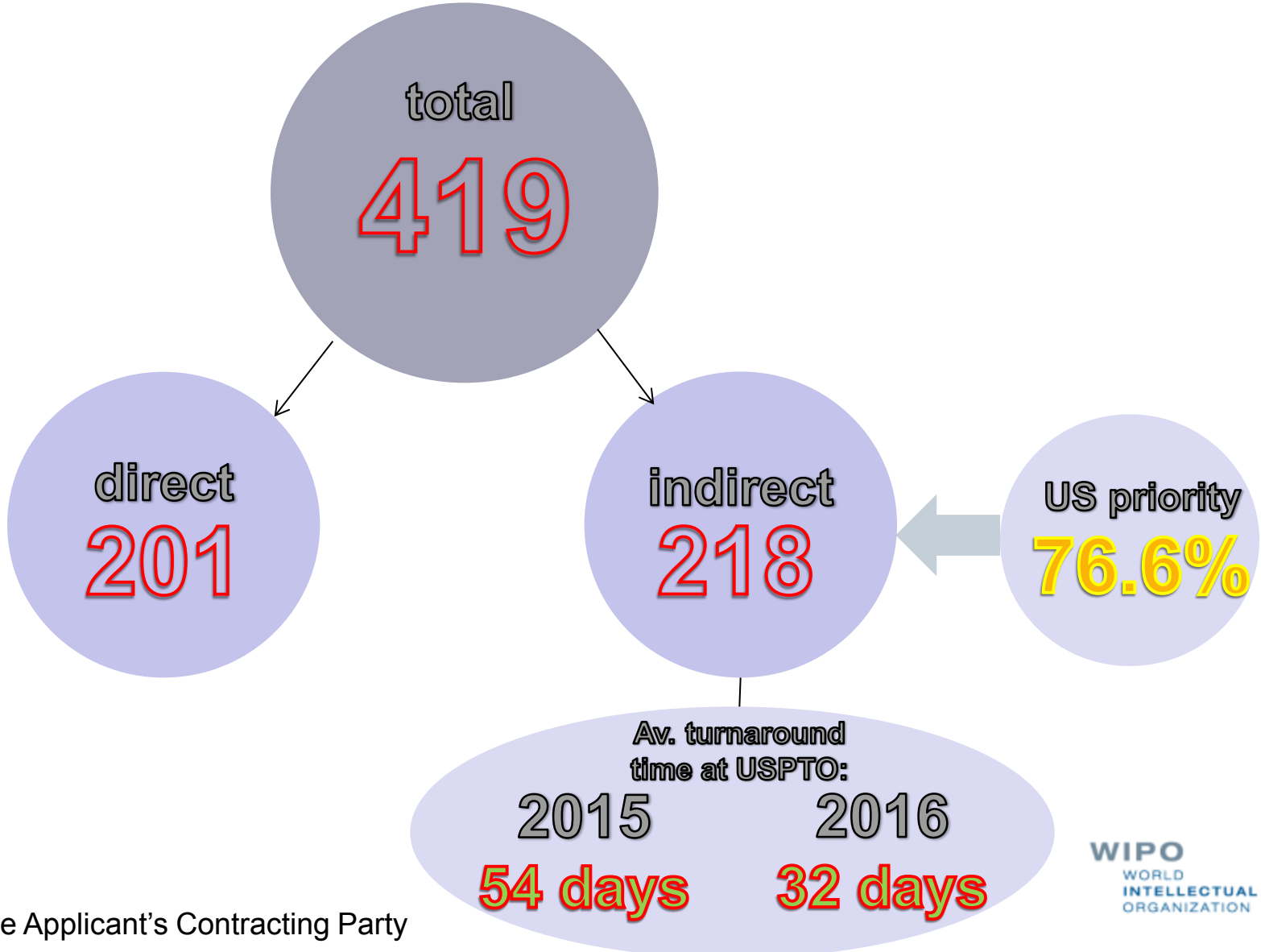

* By the Applicant's Contracting Party



Have Export License? Then File Directly

E-Filing Platform

The E-filing platform includes the following features:

a WIPO User account

facilitated downloading of reproductions

real time checking of certain formalities

saving of applications in progress

fully integrated fee calculator

payment of fees by credit card

and much more...

New Features of the E-Filing Portfolio Manager



Send corrections to irregularities or defects



Receive and download notifications from the IB relating to international applications



Retrieve in real-time current status of IA

Hague Express Database

Hague Express

The Hague Express Database, updated weekly, includes bibliographical data and, as far as international registrations governed exclusively or partly by the 1999 and/or by the 1960 Act(s) of the Hague Agreement are concerned, reproductions of industrial designs relating to international registrations that have been recorded in the International Register and published in the International Designs Bulletin as of issue No. 1/1999. International registrations that have lapsed are not removed from the database.

SEARCH BY

Design Names Numbers Dates Country

Indication of Products =

Locarno =

Description =

search 🔍

CURRENT SEARCH

PROD:watch ✖

FILTER BY

Designation Locarno Class Reg. Date * Contracting Party *

CH	1,535	MC	1,131	TN	991	MA	963	LI	960
FR	894	DE	890	IT	889	EG	887	BX	851
BE	851	NL	851	LU	851	ES	813	ME	684
MK	683	GR	666	MD	642	MN	634	SG	611
TR	594	UA	591	ID	586	EM	583	KP	556
RS	523	VA	489	SI	462	CW	409	BQ	408
SX	406	GE	380	RO	378	KG	376	BZ	364

Display: List Sort: Count - desc

filter ▼

1 - 10 / 1,627

edit columns <>

10 per page 1 / 163

Reg. No	Holder	Reg. Date	Locarno Cl	Ind. Prod.	Des.	Designs	Image
DM/046674	HYSEK JÖRG	1999-02-03	03-01	Etui pour montre	AN,EG,ES,ID,MA,TN,V	1	
DM/082429	CARTIER CREATION STUDIO SA	2013-12-13	10-02	1. Watch; 2. Watch case; 3. Watch dial; 4. Watch; 5. Watch bracelet; 6. Watch dial; 7. Watch dial	CH,EM,SG,TR	8	
DM/083367	FRANCK MULLER WATCHLAND SA	2014-04-09	10-02	1. Montre-bracelet	EM,MC,SG	1	
DM/065362	SWATCH AG (SWATCH SA) (SWATCH LTD.)	2004-05-12	10-02	1. Montre-bracelet	BQ,CW,EG,ID,SX,TN,I	1	
DM/073485	BÉDAT & CO SA	2010-03-26	10-02	Watch	BX,KP,CH,EM,LI,OA,S	1	
DM/073351	HUBLOT SA, GENÈVE	2010-03-18	10-02	Watch	CH,EM,SG	1	
DM/073317	OMEGA SA (OMEGA AG) (OMEGA LTD.)	2010-02-12	10-02	Watch	BZ,MA,MC,ME,AL,AM,I	1	
DM/072570	ALEXIS BARTHELAY (SOCIÉTÉ ANONYME)	2009-10-20	10-02	Watch	MA,CH,EG,EM,OM,SG	1	

Global Design Database

Global Design Database

A world-wide collection of industrial designs data; including WIPO Hague registrations and information from participating national offices.

SEARCH BY

Design | Names | Numbers | Dates | Country

Indication of Products =

Design class =

Description =

search ↗

CURRENT SEARCH

PROD:(perfume) ✕

FILTER BY

Source | Designation | Locarno Class | Reg. Date * | Contracting Party *

CH	106	CA	94	MC	67	DE	65	BX	57
BE	57	NL	57	LU	57	FR	53	IT	47
LI	46	EG	44	MA	43	ES	41	TN	39
GR	38	TR	36	RS	36	RO	35	UA	35
ME	32	EM	32	BG	31	SG	31	HU	31
SI	29	MK	27	KP	24	MD	22	ID	20
VA	18	AN	14	BQ	11	SX	11	SN	11

Display: List ▾

Sort: Count - desc ▾







filter ▾

1 - 10 / 225

edit columns ⇄

10 per page

1 / 23

Reg. No	Source	Holder	Reg. Date	Class	Ind. Prod.	Des.	Designs	Image
DM/084555	Hague	BULGARI SPA	2014-10-02	LC.09-01	1. <i>Perfume</i> bottle	MA,CH,EM,LI,MC,SG	1	
DM/084494	Hague	BULGARI SPA	2014-09-26	LC.09-01	1. <i>Perfume</i> bottle	MA,CH,EM,LI,MC,SG	1	
DM/083330	Hague	BULGARI SPA	2014-04-04	LC.09-01	1. <i>Perfume</i> bottle	MA,CH,EM,LI,MC,SG	1	
DM/083058	Hague	COMPTOIR NOUVEAU DE LA PARFUMERIE	2014-02-20	LC.09-01	1. <i>Perfume</i> bottle	MA,CH,EM,MC,SG,T	1	
DM/082126	Hague	PACIFIC CREATION	2013-10-09	LC.09-03	1. <i>Perfume</i> packaging	CH,EG	1	
DM/081534	Hague	BOURJOIS SARL	2013-07-11	LC.09-01	1. Fragrance bottle	CH,TR	1	
DM/080039	Hague	FENDI ADELE S.R.L.	2013-01-30	LC.09-01	1. <i>Perfume</i> bottle	CH,EM,OM,SG,TR	1	

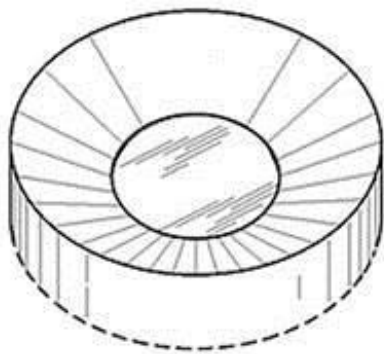

Tips

Guidance on Preparing and Providing Reproductions in Order to Forestall Possible Refusals on the Ground of Insufficient Disclosure of an Industrial Design by Examining Offices at http://www.wipo.int/export/sites/www/hague/en/how_to/pdf/guidance.pdf

- Established in consultation with Contracting Parties, in particular all those that currently have an Examining Office, and several user organizations

In Conclusion

- Many advantages in using the Hague System: flexibility of the system, tailormade designations, multiple design application, simple fee structure, and subsequent management.
- Design protection is not simple,
 - But Hague makes it simpler...

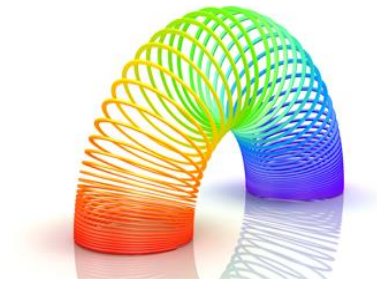

Thank you
for your attention

matthew.forno@wipo.int



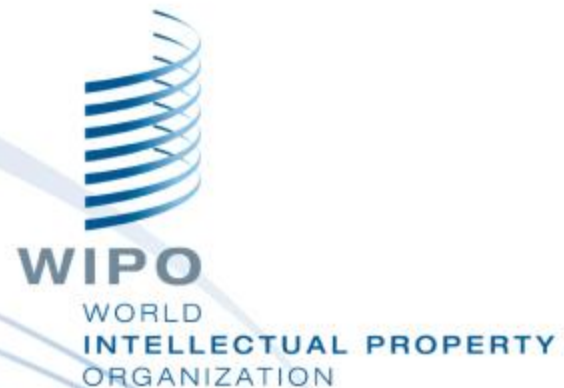

Resolving IP Disputes outside the Courts through WIPO ADR: WIPO's Arbitration and Mediation Center

Matthew Bryan
Director
Patent Cooperation Treaty Legal Division
WIPO

**San Jose, United States of America
October 31, 2016**

Top Ten Priorities in Choice of Dispute Resolution Clause (WIPO Survey)

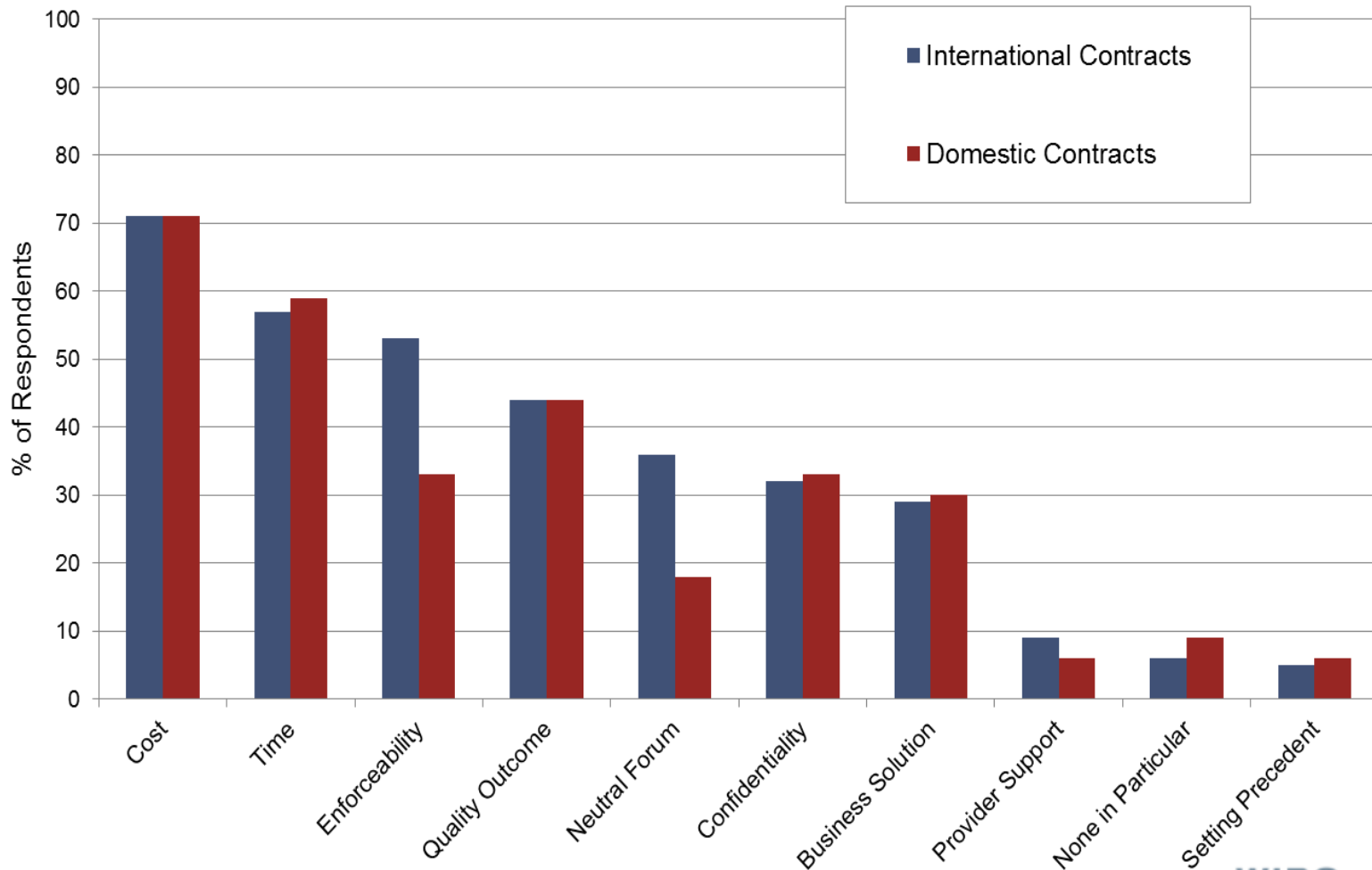

WIPO Arbitration and Mediation Center

- Facilitates the resolution of commercial disputes between private parties involving IP and technology, through procedures other than court litigation (alternative dispute resolution: ADR)
 - Offices in Geneva and Singapore
 - Users around the world
- ADR of IP disputes benefits from a specialized ADR provider
 - WIPO mediators, arbitrators and experts experienced in IP and technology - able to deliver informed results efficiently
- Competitive WIPO fees
- International neutrality
- Services include mediation, (expedited) arbitration, expert determination, and domain name dispute resolution

WIPO ADR

Mediation, Arbitration, Expert Determination

- **Mediation:** informal consensual process in which a neutral intermediary, the mediator, assists the parties in reaching a settlement of their dispute, based on the parties' respective interests. The mediator cannot impose a decision. The settlement agreement has force of contract. Mediation leaves open available court or agreed arbitration options.
- **Arbitration:** consensual procedure in which the parties submit their dispute to one or more chosen arbitrators, for a binding and final decision (award) based on the parties' rights and obligations and enforceable internationally. Arbitration normally forecloses court options.
- **Expert Determination:** consensual procedure in which the parties submit a specific matter (e.g., technical question) to one or more experts who make a determination on the matter, which can be binding unless the parties have agreed otherwise.

Why Consider WIPO ADR?

- Cost of IP court litigation
 - *Calls for expedient solutions*
- Internationalization of creation/use of IP
 - *Calls for cross-border solutions; consolidate in one procedure*
- Technical and specialized nature of IP
 - *Calls for specific expertise of the neutral*
- Short product and market cycles in IP
 - *Calls for time-efficient procedures*
- Confidential nature of IP
 - *Calls for private procedures*
- Collaborative nature of IP creation and commercialization
 - *Calls for mechanisms that preserve relations*

Routes to WIPO ADR

- ADR contract clause electing WIPO Rules
 - WIPO Mediation, and/or
 - WIPO Arbitration / Expedited Arbitration, and/or
 - WIPO Expert Determination
- Model clauses: www.wipo.int/amc/en/clauses/index.html
 - Parties can shape the process via the clause (e.g., location, language, law)
- ADR submission agreement electing WIPO Rules, e.g., in existing non-contractual disputes
- Unilateral request for WIPO Mediation by one party (Art. 4 WIPO Mediation Rules)
- Court referrals

WIPO ADR Options

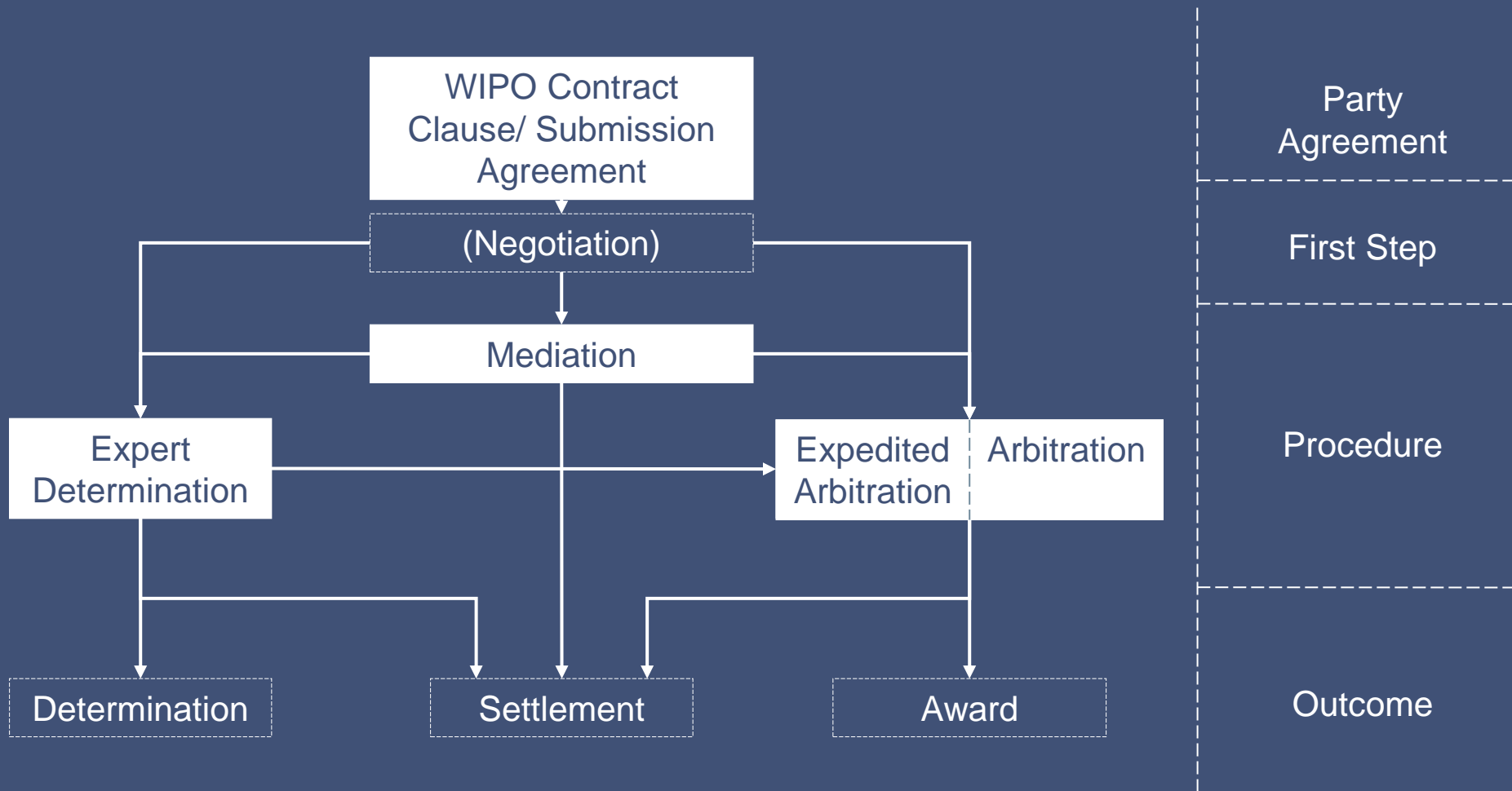

WIPO Model Clause Example: Mediation followed by Expedited Arbitration

"**Any dispute**, controversy or claim arising under, out of or relating to this contract and any subsequent amendments of this contract, including, without limitation, its formation, validity, binding effect, interpretation, performance, breach or termination, as well as non-contractual claims, **shall be submitted to mediation in accordance with the WIPO Mediation Rules**. The place of mediation shall be **[specify place]**. The language to be used in the mediation shall be **[specify language]**"

If, and to the extent that, **any such dispute**, controversy or claim **has not been settled pursuant to the mediation within [60][90] days of the commencement of the mediation**, it shall, **upon the filing of a Request for Arbitration by either party, be referred to and finally determined by arbitration in accordance with the WIPO Expedited Arbitration Rules**. Alternatively, if, before the expiration of the said period of [60][90] days, either party fails to participate or to continue to participate in the mediation, the dispute, controversy or claim shall, upon the filing of a Request for Arbitration by the other party, be referred to and finally determined by arbitration in accordance with the WIPO Expedited Arbitration Rules. The place of arbitration shall be **[specify place]**. The language to be used in the arbitral proceedings shall be **[specify language]**. The dispute, controversy or claim referred to arbitration shall be decided in accordance with **[specify jurisdiction]** law."

WIPO Clause Generator

Step 3 – Build your clause: WIPO Mediation followed, in the absence of a settlement, by Arbitration Clause

Mediation

The parties should determine where they want the mediation to take place.

The place of mediation shall be .

Any dispute, controversy or claim arising under, out of or relating to this contract and any subsequent amendments of this contract, including, without limitation, its formation, validity, binding effect, interpretation, performance, breach or termination, as well as non-contractual claims, shall be submitted to mediation in accordance with the WIPO Mediation Rules.

The place of mediation shall be [specify place].

The language to be used in the mediation shall be [specify language].

If, and to the extent that, any such dispute, controversy or claim has not been settled pursuant to the mediation within [specify timeline] days of the commencement of the mediation, it shall, upon the filing of a Request for Arbitration by either party, be referred to and finally determined by arbitration in accordance with the WIPO Arbitration Rules. Alternatively, if, before the expiration of the said period of [specify timeline] days, either party fails to participate or to continue to participate in the mediation, the dispute, controversy or claim shall, upon the filing of a Request for Arbitration by the other party, be referred to and finally determined by arbitration in accordance with the WIPO Arbitration Rules.

The arbitral tribunal shall consist of [a sole arbitrator][three arbitrators].

The place of arbitration shall be [specify place].

The language to be used in the arbitral proceedings shall be [specify language].

The dispute, controversy or claim shall be decided in accordance with the law of [specify jurisdiction].

Core Elements ?

Place of Mediation

Language of the Mediation

Duration of the Mediation Proceedings

Additional Elements ?

Qualifications of the Mediator

Conduct of the Mediation

Arbitration

Core Elements ?

Number of Arbitrators

Place of Arbitration

Language of Arbitration

Substantive Law

Additional Elements ?

Appointment Procedure

Qualifications of the Arbitrators

ECAF

Evidence

Time Period of Delivery of the Final Award

Appeal

Step 4 – Download or copy the final result

WIPO Center Case Role

- Administering cases
 - Under WIPO Rules, or under special procedures
 - Active management: containing time and costs
 - WIPO ECAF (optional online case management)
- Facilitating selection and appointment of mediators, arbitrators, experts
 - WIPO list of 1,500+ neutrals
 - From numerous countries in all regions
 - Specialized in different areas of IP and IT

WIPO Electronic Case Facility (ECAF)

- Simple; secure; instant; location-independent; optional

ECAF HOME
Help
Arbitration
Mediation
Expert Determination
Logout

WIPO Electronic Case Facility (ECAF)

Case: WIPOA20020

Licensing v. AB Technics Inc.

Case Overview | Contact Information | **Case File** | Message Board | Neutral Message Board

Case File

Only documents to be recorded as part of the casefile should be submitted in the Case File.
Only first-level submissions will trigger an email notification to users.
Display issues from variations in browsers may be resolved by adjusting the Text Size in the browser menu.

 [Search Case](#)

 [Submit New File](#)

[Expand](#) | [Collapse](#)

To sort, you may click on the column headers

ITEM NO	SUBMITTED BY	DATE	SUBJECT	ANNEX
3	WIPO AMC Case Manager	04/06/09 14:44:26	Main Case File 3	1 [Add]
3.1		04/06/09 14:45:21	Annex 1	[Add]
2	WIPO AMC Case Manager	22/05/09 16:11:02	Main Case File 2	2 [Add]
2.1		22/05/09 16:11:22	Annex 1	3 [Add]
2.1.1		02/06/09 11:03:17	Annex 1	
2.1.2		21/09/09 12:05:27	Annex 2	

WIPO Arbitration

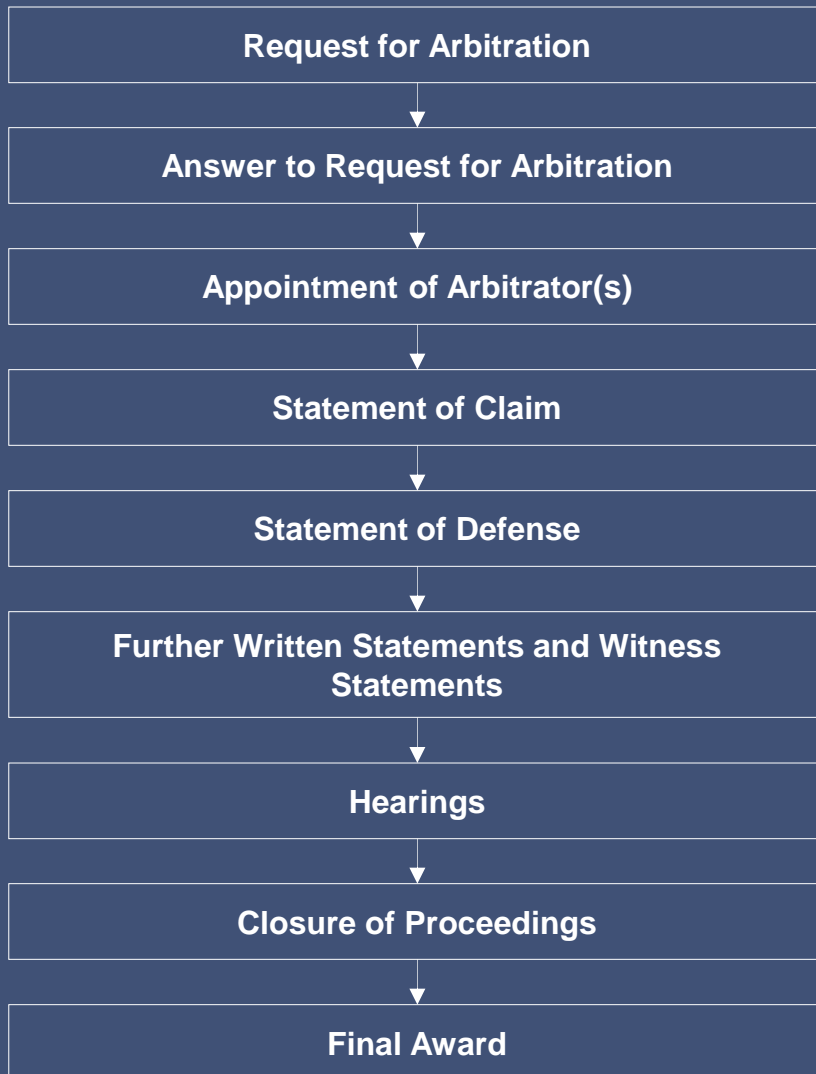

WIPO Expedited Arbitration

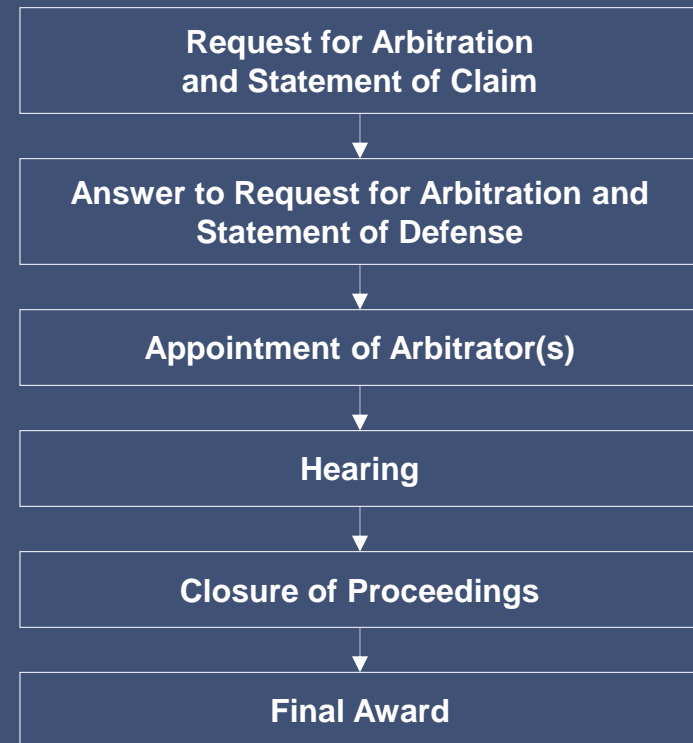

- One exchange of pleadings
- Shorter time limits
- Sole arbitrator
- Shorter hearings
- Fixed fees

WIPO Mediation, Arbitration and Expert Determination Cases

- IP/IT disputes and commercial disputes, for example:
 - Contractual: patent licenses, software/ICT, R&D and technology transfer agreements, patent pools, distribution agreements, joint ventures, copyright collecting societies, trademark coexistence agreements, settlement agreements
 - Non-contractual: infringement of IP rights
- Domestic and international disputes (25/75%)
- Case venues around the world
- Amounts in dispute from USD 50,000 to USD 1 billion

Dispute Areas in WIPO Mediation and Arbitration Cases

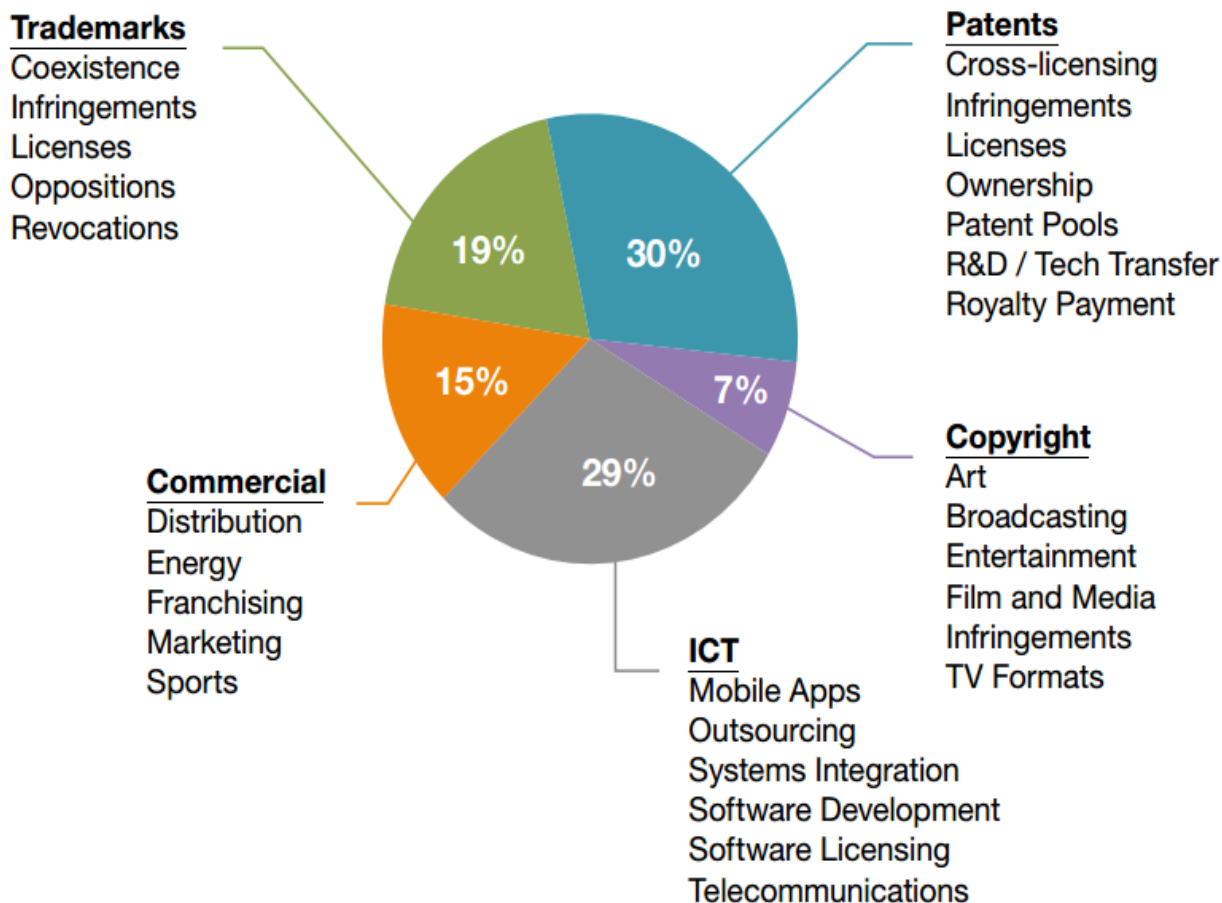

WIPO Cases: Typical Time and Cost

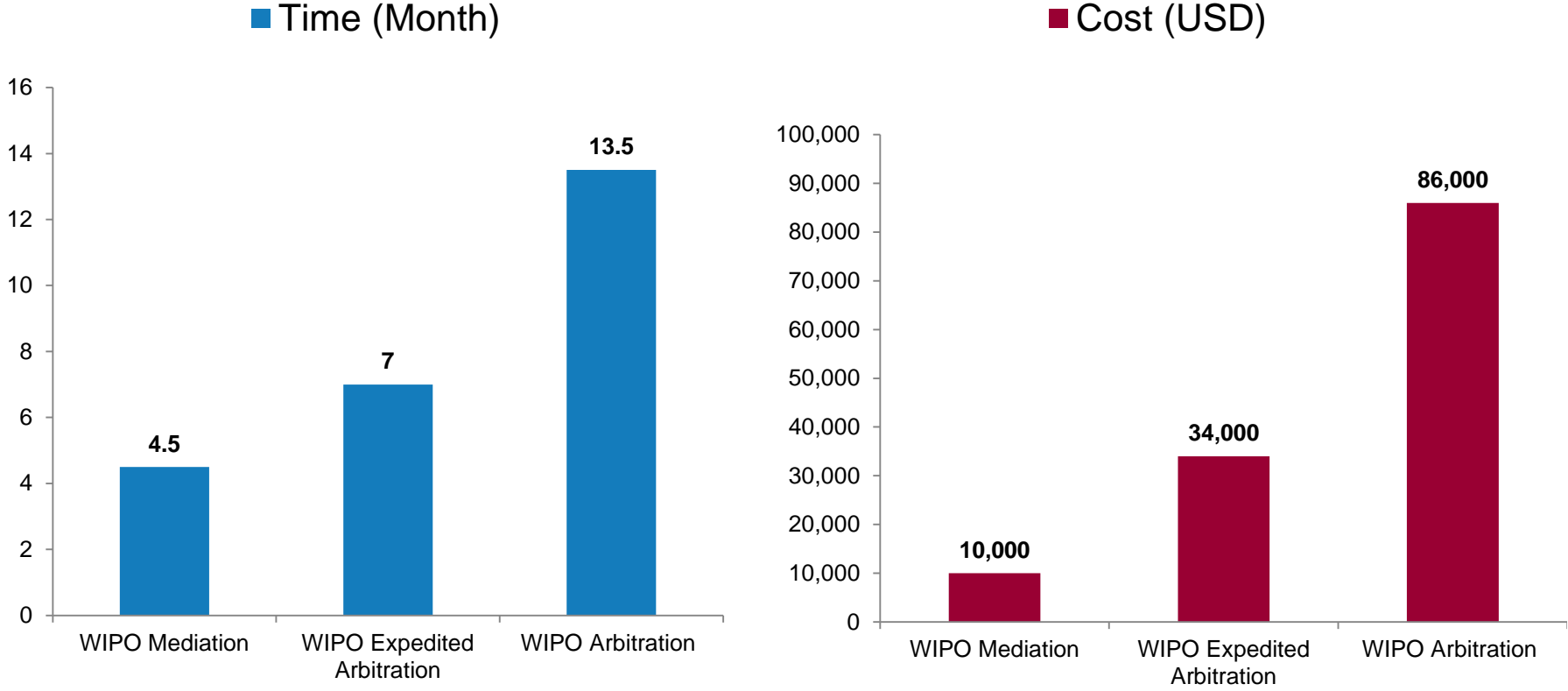

* Excluding cost of parties legal representation

Mediation, (Expedited) Arbitration, Expert Determination Fee Calculator

The fees referenced below are estimates, in **United States dollars**. Final amounts payable are to be decided in consultation with the [Center](#).

Type of Procedure



Amount in Dispute in USD



Dispute is not quantifiable or Request does not indicate any claims for a monetary amount



WIPO PCT Filer, Hague System Filer, Madrid System Filer, WIPO Green Technology Provider or Seeker



Calculate

Reset

Registration Fee No Registration Fee

Administration Fee USD 375

Mediator's Fee USD 300-USD 600 per hour USD 1,500-USD 3,500 per day.

Schedule of Fees

Mediation

Arbitration / Expedited Arbitration

Expert Determination

Emergency Relief Proceedings (Effective from June 1, 2014)

For further information and payment details, click on the applicable schedule of fees and costs on the right hand side of the page.

Relative Time and Cost of Technology Dispute Resolution

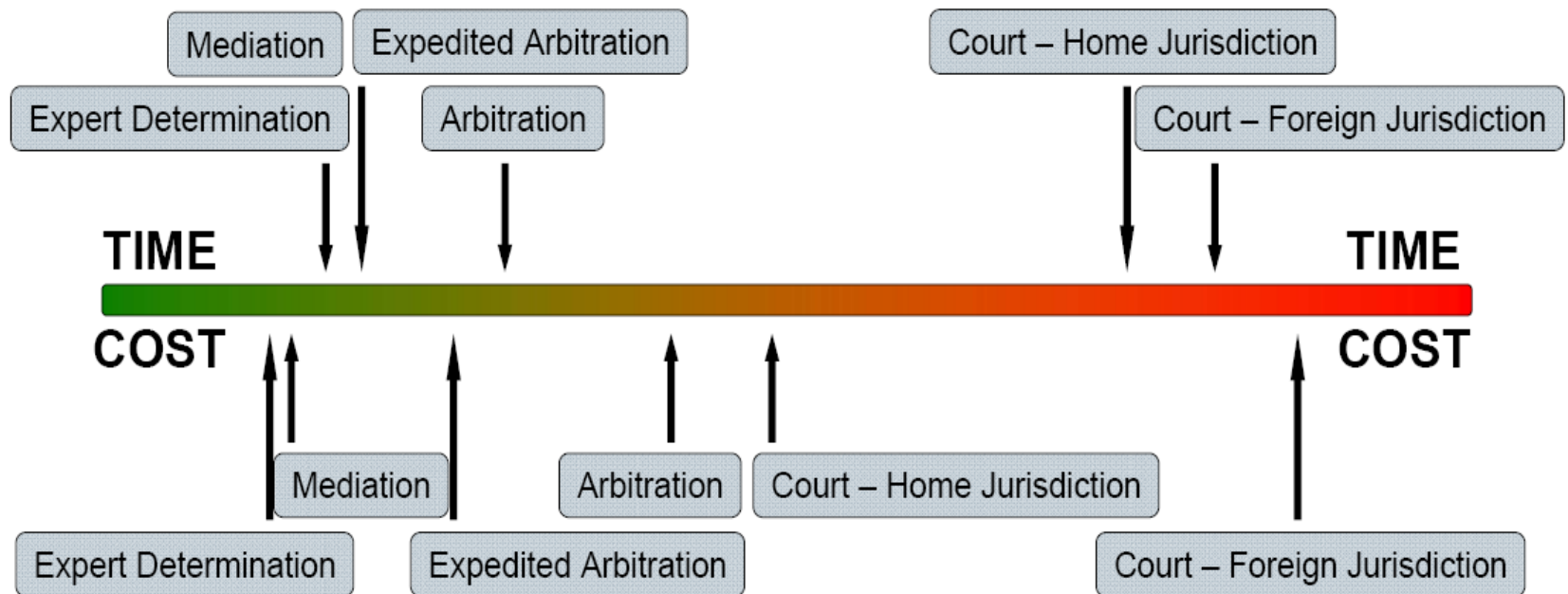

Uniform Domain Name Dispute Resolution Policy (UDRP)

- 1999: WIPO-created international administrative ADR procedure
- Allows trademark owners to resolve “clear cut” cases of abusive domain name registration and use (“cybersquatting”)
- Operates outside the courts, but preserves party court option
- Uniform: applicable to all gTLDs “old” (.com, .net, .org, etc.) and “new” (.bike, .nyc, .xyz, etc.)
 - Also available for 75 ccTLDs
- Applicable via mandatory “contract web” between ICANN, registrars, and registrants

UDRP: Principal Advantages

- Significantly quicker and cheaper than court litigation
 - Two-month average; fixed fees (USD 1,500)
- Predictable criteria and results
- Decision (transfer) implemented directly by registrar
- Prevents consumer confusion/brand abuse

The UDRP Test – Three Elements

- Trademark must be **identical or confusingly similar** to the domain name; and
- The registrant of the domain name must have **no rights or legitimate interests** in the domain name; and
- The domain name must have been registered and used **in bad faith**.

home

product search:

Products List

New Arrival

- ☐ clothing for male
- ☐ clothing for female
- ☐ shoes for male
- ☐ shoes for female

Clothing For Male

- ☐ Coat
- ☐ Sweater
- ☐ T-Shirt
- ☐ Suit
- ☐ Jean
- ☐ Jacket
- ☐ Shirt

- ☐ Hoody
- ☐ Short

THE NORTH FACE

Clothing For Female

- ☐ Hoody
- ☐ Coat
- ☐ Suit
- ☐ Jacket
- ☐ Women sweater

new arrivals



[188278](#)

[Jordan Team Iso M 6](#)

free shipping

price:\$45

BUY NOW



[188196](#)

[Monder vest W 29](#)

free shipping

price:\$95

BUY NOW



[188061](#)

[air MAX TN M 34](#)

free shipping

price:\$38

BUY NOW



[187995](#)

[air max 2011 M 2](#)

free shipping

price:\$37

BUY NOW



[187927](#)

[Michael Joseph Jackson t-](#)



[187329](#)

[ARMANI t-shirt boys 23](#)



[187249](#)

[Nike Air Max 24-7 kid 6](#)



[187137](#)

[Jordan six Ring&4 M 6](#)

Domain Name Dispute Filing with WIPO

- 16 years' experience as the global leader in domain name dispute resolution
 - 35,000+ cases covering 65,000+ domain names
 - 2015 total: 2,754 cases
 - Involving parties based in 113 countries
 - Multilingual case administration (21 languages to date)
 - Paperless filing: WIPO-initiated eUDRP
 - US first-ranked for WIPO case parties and panelists

WIPO UDRP Complainant Areas of Activity

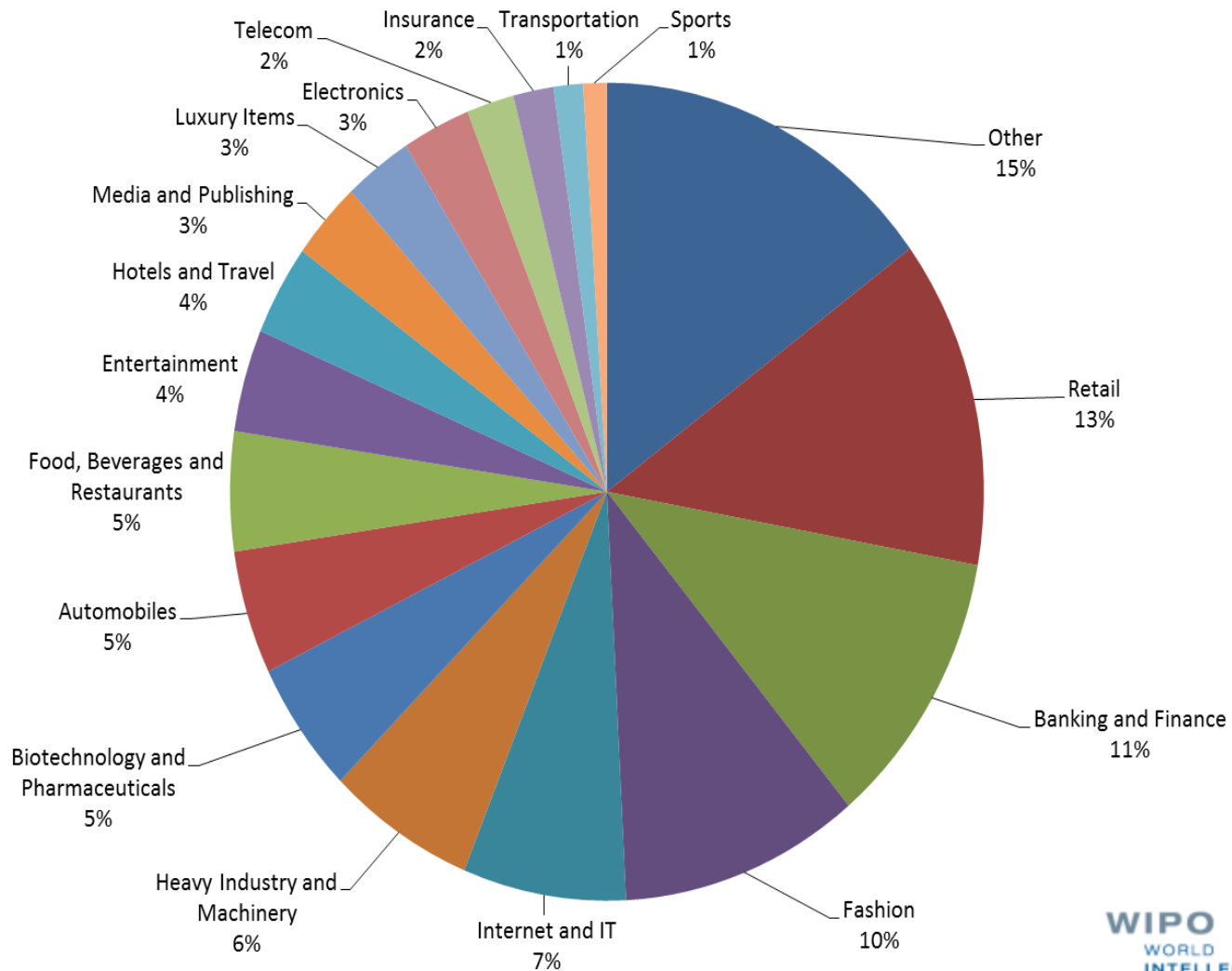

Key WIPO UDRP Resources

- WIPO Guide to the UDRP

www.wipo.int/amc/en/domains/guide

- Model pleadings (complaint and response)

www.wipo.int/amc/en/domains/complainant

- Legal Index of UDRP Decisions

www.wipo.int/amc/en/domains/search/index.html

- WIPO Jurisprudential Overview of Selected UDRP Questions

www.wipo.int/amc/en/domains/search/overview/index.html

WIPO Overview of WIPO Panel Views on Selected UDRP Questions, Second Edition ("WIPO Overview 2.0")

1. First UDRP Element

- 1.1 Does ownership of a registered trademark to which the domain name is identical or confusingly similar automatically satisfy the requirements under paragraph 4(a)(i) of the UDRP?
- 1.2 What is the test for identity or confusing similarity, and can the content of a website be relevant in determining this?
- 1.3 Is a domain name consisting of a trademark and a negative term confusingly similar to the complainant's trademark? ("sucks cases")
- 1.4 Does the complainant have UDRP-relevant trademark rights in a trademark that was registered, or in which the complainant acquired unregistered rights, after the domain name was registered?
- 1.5 Can a complainant show UDRP-relevant rights in a geographical term or identifier?
- 1.6 Can a complainant show UDRP-relevant rights in a personal name?
- 1.7 What needs to be shown for the complainant to successfully assert common law or unregistered trademark rights?
- 1.8 Can a trademark licensee or a related company to a trademark holder have rights in a trademark for the purpose of filing a UDRP case?
- 1.9 Is a domain name consisting of a trademark and a generic, descriptive or geographical term confusingly similar to a complainant's trademark?
- 1.10 Is a domain name which contains a common or obvious misspelling of a trademark (i.e., typosquatting) confusingly similar to a complainant's trademark?
- 1.11 Are disclaimed or design elements of a trademark considered in assessing identity or confusing similarity?

2. Second UDRP Element

- 2.1 Is the complainant required to prove that the respondent lacks rights or legitimate interests in the disputed domain name?
- 2.2 Does a respondent automatically have rights or legitimate interests in a domain name comprised of a dictionary word(s)?
- 2.3 Can a reseller/distributor of trademarked goods or services have rights or legitimate interests in a domain name which contains such trademark?
- 2.4 Can a criticism site generate rights or legitimate interests in the disputed domain name?
- 2.5 Can a fan site generate rights or legitimate interests in the disputed domain name?
- 2.6 Do parking and landing pages or pay-per-click (PPC) links generate rights or legitimate interests in the disputed domain name?
- 2.7 Does a respondent trademark corresponding to a disputed domain name automatically generate rights or legitimate interests?

3. Third UDRP Element

- 3.1 Can bad faith be found if the domain name was registered before the trademark was registered or before unregistered trademark rights were acquired?
- 3.2 Can there be use in bad faith when the domain name is not actively used and the domain name holder has taken no active steps to sell the domain name or to contact the trademark holder (passive holding)?
- 3.3 What constitutes a pattern of conduct of preventing a trademark holder from reflecting the mark in a corresponding domain name?
- 3.4 Can constructive notice, or a finding that a respondent "knew or should have known" about a trademark, or willful blindness, form a basis for finding bad faith?
- 3.5 What is the role of a disclaimer on the web page of a disputed domain name?
- 3.6 Can statements made in settlement discussions be relevant to showing bad faith?
- 3.7 Does the renewal of the registration of a domain name amount to a registration for the purposes of determining whether the domain name was registered in bad faith?
- 3.8 Can third-party or "automatically generated" material appearing on a website form a basis for finding registration and/or use in bad faith?
- 3.9 Can use of a privacy or proxy registration service form a basis for finding bad faith?
- 3.10 Can the use of "robots.txt" or similar mechanisms to prevent website content being accessed in an on-line archive form a basis for finding in bad faith?
- 3.11 Can tarnishment of a trademark form a basis for finding bad faith?

Further Information (1)

- WIPO Arbitration and Mediation Center Offices

- Geneva, Switzerland
- Singapore, Singapore

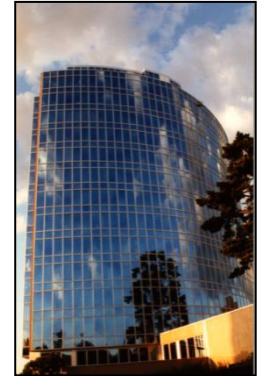

- WIPO External Offices

- Rio de Janeiro, Brazil
- Beijing, China
- Tokyo, Japan
- Moscow, Russia
- Singapore, Singapore



Further Information (2)

- Queries and case filing:
arbiter.mail@wipo.int
- Model clauses:
www.wipo.int/amc/en/clauses/
- Info on procedures, neutrals and case examples:
www.wipo.int/amc/

Global IP Databases, Platforms and Tools for the Connected Knowledge Economy



Irene Kitsara, IP Information Officer,
Access to Information and Knowledge Division,
Global Infrastructure Sector

Outline

- A. Global IP Databases
 - PATENTSCOPE
 - Global Brand Database
 - Global Design Database
 - WIPO DAS
 - WIPO Lex

- B. Tools facilitating understanding of patent data and IP Management-related decisions
 - Patent Analytics (Patent Landscape Reports (PLR) and related resources)

- C. Collaboration platforms
 - WIPO RE:SEARCH
 - WIPO GREEN
 - WIPO Match

The importance of infrastructure in a knowledge economy



“Just as participation in the physical economy requires access to roads, bridges, and vehicles to transport goods, similar infrastructure is needed in the virtual and knowledge economy. However, here the highway is the Internet and other networks, bridges are interoperable data standards, and vehicles are computers and databases” Director General Francis Gurry

- Challenges of:
 - **Access** to relevant information (information sources, tools and search skills)
 - **Analysis, understanding and strategic use** of information (content understanding, decision-making, establishment of partnerships)

A. Global IP Databases: Access point

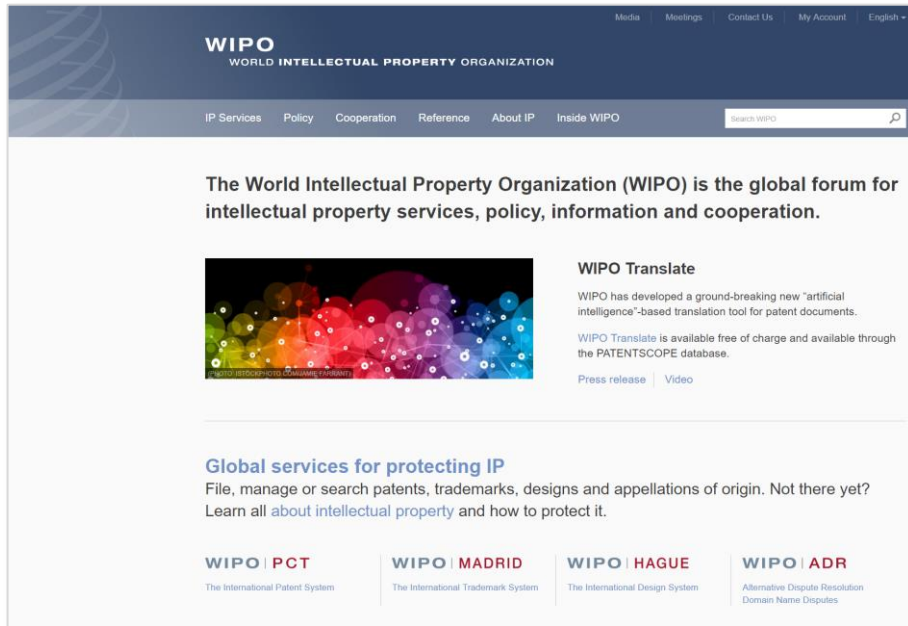

The screenshot shows the WIPO website homepage. At the top, there is a dark blue header with the WIPO logo and the text "WORLD INTELLECTUAL PROPERTY ORGANIZATION". Below the header, there is a navigation menu with links for "IP Services", "Policy", "Cooperation", "Reference", "About IP", and "Inside WIPO". A search bar is located on the right side of the header. The main content area features a large heading: "The World Intellectual Property Organization (WIPO) is the global forum for intellectual property services, policy, information and cooperation." Below this, there is a colorful graphic of interconnected nodes and lines, representing a network or data structure. To the right of the graphic, there is a section titled "WIPO Translate" with a brief description of the tool and a link to a press release or video. At the bottom of the page, there are four logos for WIPO systems: PCT (The International Patent System), MADRID (The International Trademark System), HAGUE (The International Design System), and ADR (Alternative Dispute Resolution Domain Name Disputes).

www.wipo.int

Access to the world's IP information

Search technology, [terminology](#) and brand-related information in our free global databases. Download our other reference materials: [publications](#), [statistics](#), [economic studies](#) and more.

PATENTSCOPE

57,450,000 international and national patent documents

Global Brand Database

27,520,000 international and national records of trademarks, appellations of origin and emblems

ROMARIN

International marks recorded under the Madrid System

Global Design Database

1,600,000 industrial design registrations from the Hague System and participating national collections

WIPO Lex

14,100 records of national IP laws and treaties of some 200 countries



The infographic shows a bar chart with the title "WIPO/LED THE MOST PCT PATENT APPLICATIONS IN 2015". The chart displays data for various countries, with the U.S. having the highest number of filings. Below the chart, there is a text box with the title "International IP filings in 2015" and the subtitle "U.S. Extends Lead in International Patent and Trademark Filings." There are also links for "Press release" and "Infographic PDF".

Growing importance of patent information

Patent applications and grants worldwide

A1 Trend in patent applications worldwide

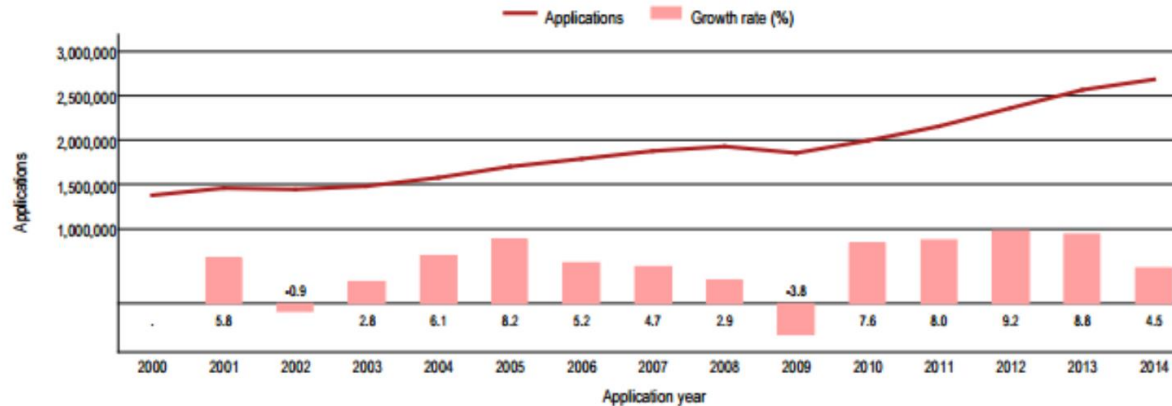

Note: WIPO estimates cover 147 patent offices and include direct applications and Patent Cooperation Treaty national phase entry data (where applicable).

Source: WIPO Statistics Database, October 2015.

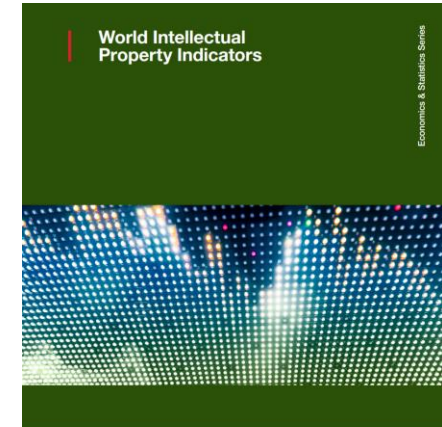

2015



- Increase in patent applications worldwide and in the information included therein
- PATENTSCOPE: 58 mio patent documents
- Challenge: access to the information and pertinence of the retrieved information

WIPO's Patent Database: PATENTSCOPE

Access to the world's IP information

Search technology, terminology and brand-related information in our free global databases. Download our other reference materials: publications, statistics, economic studies and more.

PATENTSCOPE

57,240,000 international and national patent documents

Global Brand Database

26,690,000 international and national records of trademarks, appellations of origin and emblems

ROMARIN

International marks recorded under the Madrid System

Global Design Database

1,600,000 industrial design registrations from the Hague System and participating national collections

WIPO Lex

14100 records of national IP laws and treaties of some 200 countries

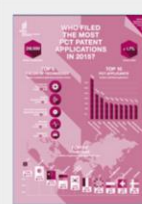

International IP filings in 2015

U.S. Extends Lead in International Patent and Trademark Filings.

[Press release](#) | [Infographic](#) [PDF](#)

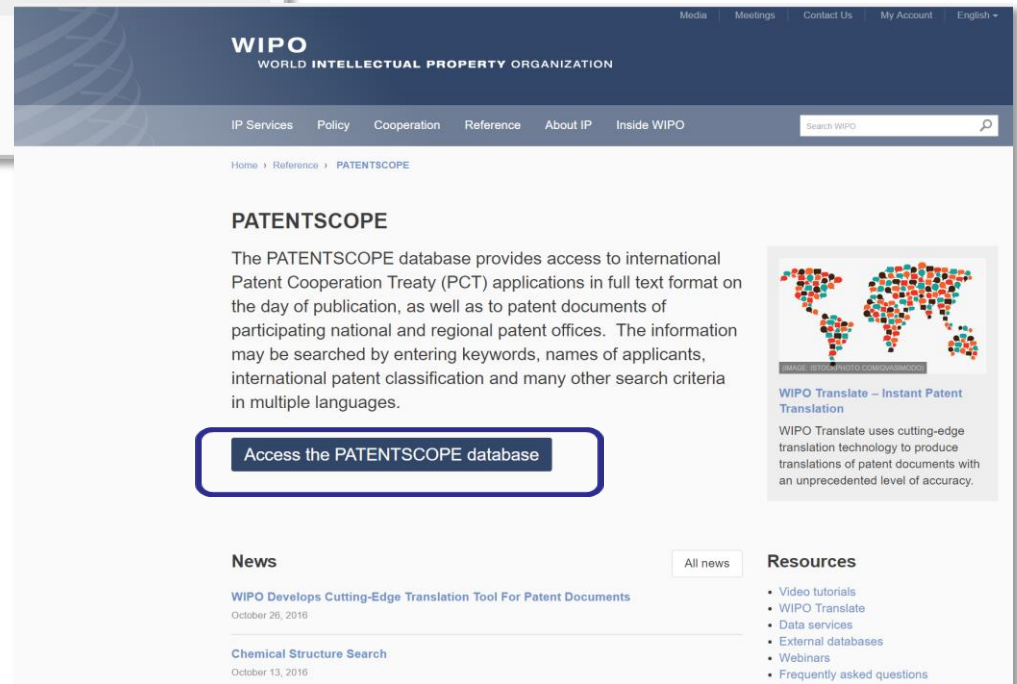

The screenshot shows the WIPO PATENTSCOPE website. At the top is the WIPO logo and navigation links. Below is a search bar and a menu. The main content area features the title 'PATENTSCOPE' and a descriptive paragraph. A prominent button reads 'Access the PATENTSCOPE database'. To the right is a 'WIPO Translate' section. At the bottom, there are 'News' and 'Resources' sections.

WIPO
WORLD INTELLECTUAL PROPERTY ORGANIZATION

Media | Meetings | Contact Us | My Account | English

IP Services | Policy | Cooperation | Reference | About IP | Inside WIPO

Home > Reference > PATENTSCOPE

PATENTSCOPE

The PATENTSCOPE database provides access to international Patent Cooperation Treaty (PCT) applications in full text format on the day of publication, as well as to patent documents of participating national and regional patent offices. The information may be searched by entering keywords, names of applicants, international patent classification and many other search criteria in multiple languages.

[Access the PATENTSCOPE database](#)

WIPO Translate – Instant Patent Translation
WIPO Translate uses cutting-edge translation technology to produce translations of patent documents with an unprecedented level of accuracy.

News All news

WIPO Develops Cutting-Edge Translation Tool For Patent Documents
October 26, 2016

Chemical Structure Search
October 13, 2016

Resources

- Video tutorials
- WIPO Translate
- Data services
- External databases
- Webinars
- Frequently asked questions

PATENTSCOPE and its search functionalities

World Intellectual Property Organization [CH] | <https://patentscope.wipo.int/search/en/search.jsf>

WIPO PATENTSCOPE

Search International and National Patent Collections

WORLD INTELLECTUAL PROPERTY ORGANIZATION

Search Browse Translate Options News Login Help

Simple
Advanced Search
Field Combination
Cross Lingual Expansion

Front Page Office: All Search

PCT Publication 40/2016 (2016/10/06) is now available. The next publication date is scheduled as follows: Gazette number 41/2016 (2016/10/13). [More](#)

- 3 million published PCT applications
- 58 million patent documents (regional and national collections)

<https://patentscope.wipo.int>

PATENTSCOPE: Advanced search

WIPO **PATENTSCOPE** [Mobile](#) | [Deutsch](#) | [Español](#) | [Français](#) | [日本語](#) | [한국어](#)

Search International and National Patent Collections

WORLD INTELLECTUAL PROPERTY ORGANIZATION

[Search](#) | [Browse](#) | [Translate](#) | [Options](#) | [News](#) | [Login](#) | [Help](#)

Home > IP Services > PATENTSCOPE

Advanced Search

Search For:

Language: **Stem:** **Office:** [Specify](#)

- All
- PCT
- Africa
 - ARIPO
 - Egypt
 - Kenya
 - Morocco
 - Tunisia
 - South Africa
- Americas
 - United States of America
 - Canada
- LATIPAT
 - Argentina
 - Brazil
 - Chile
 - Colombia
 - Costa Rica
 - Cuba
 - Dominican Rep.
 - Ecuador
 - El Salvador
 - Guatemala
 - Honduras
 - Mexico
 - Nicaragua
 - Panama
 - Peru
 - Uruguay
- Asia-Europe
 - Bahrain
 - China
 - Eurasian Patent Office
 - Estonia
 - European Patent Office
 - Germany
 - Germany(DDR data)
 - Israel
 - Japan
 - Jordan
 - Portugal
 - Russian Federation
 - Russian Federation(USSR data)
 - Singapore
 - Spain
 - Republic of Korea
 - Viet Nam
 - United Arab Emirates
 - United Kingdom



Palo Alto, California, United States

PATENTSCOPE: Field combination

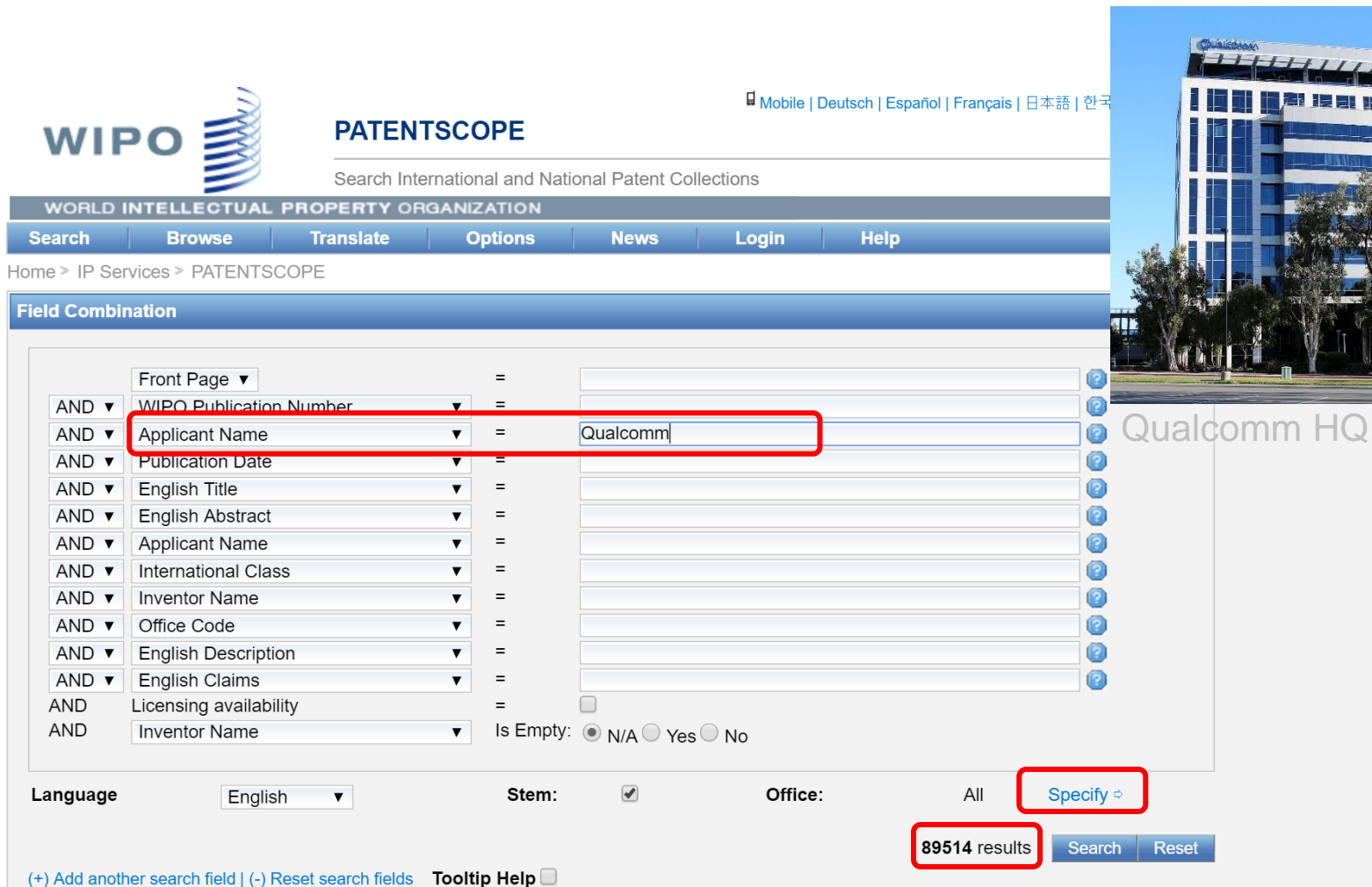

The screenshot displays the WIPO PATENTSCOPE search interface. At the top, the WIPO logo and 'PATENTSCOPE' title are visible, along with language options: Mobile | Deutsch | Español | Français | 日本語 | 한국. Below this is a navigation bar with 'Search', 'Browse', 'Translate', 'Options', 'News', 'Login', and 'Help'. The breadcrumb trail reads 'Home > IP Services > PATENTSCOPE'. The main section is titled 'Field Combination' and contains a search form with the following fields:

Field	Operator	Value
Front Page	=	
AND WIPO Publication Number	=	
AND Applicant Name	=	Qualcomm
AND Publication Date	=	
AND English Title	=	
AND English Abstract	=	
AND Applicant Name	=	
AND International Class	=	
AND Inventor Name	=	
AND Office Code	=	
AND English Description	=	
AND English Claims	=	
AND Licensing availability	=	<input type="checkbox"/>
AND Inventor Name	Is Empty:	<input checked="" type="radio"/> N/A <input type="radio"/> Yes <input type="radio"/> No

Below the search form, the 'Language' is set to 'English', 'Stem' is checked, and 'Office' is set to 'All'. A 'Specify' button is highlighted. The search results are displayed as '89514 results'. 'Search' and 'Reset' buttons are also visible. At the bottom, there are links for '+ Add another search field | (-) Reset search fields' and a 'Tooltip Help' checkbox.



Qualcomm HQ, San Diego

CLIR: Cross Lingual Expansion



PATENTSCOPE

[Mobile](#) | [Deutsch](#) | [Español](#) | [Français](#) | [日本語](#) | [한국어](#) | [Português](#) | [Русский](#) | [中文](#) | [العربية](#) |

Search International and National Patent Collections

WORLD INTELLECTUAL PROPERTY ORGANIZATION

[Search](#)

[Browse](#)

[Translate](#)

[Options](#)

[News](#)

[Login](#)

[Help](#)

Home > IP Services > PATENTSCOPE

Input search terms

[\[Help\]](#)

Query

drone

Query Language:

Expansion Mode:

Precision | 0 | 4 | Recall

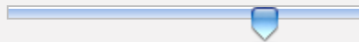

[Next](#)

Drones on CLIR



PATENTSCOPE

Mobile | Deutsch | Español | Français | 日本語 | 한국어 | Português | Русский | 中文 | العربية |

Search International and National Patent Collections

WORLD INTELLECTUAL PROPERTY ORGANIZATION

Search

Browse

Translate

Options

News

Login

Help

Home > IP Services > PATENTSCOPE

Input search terms

[Help]

Query **Domains [AERO,MEAS,MILI,MINE,SPRT]**

[ADMN] Admin, Business, Management & Soc Sci
[AGRI] Agriculture, Fisheries & Forestry
[AUDV] Audio, Audiovisual, Image & Video Tech
[AUTO] Automotive & Road Vehicle Engineering
[BLDG] Civil Engineering & Building Construction
[CHEM] Chemical & Materials Technology
[DATA] Computer Sci, Telecom & Broadcasting
[ELEC] Electrical Engineering & Electronics
[ENGY] Energy, Fuels & Heat Transfer Eng
[ENVR] Environmental & Safety Engineering
[FOOD] Foods & Food Technology
[GENR] Generalities, Language, Media & Info Sci
[HOME] Home Contents & Household Maintenance
[HORO] Precision Mechanics, Jewelry & Horology
[MANU] Manufacturing & Materials Handling Tech

Add

Remove

[AERO] Aeronautics & Aerospace Engineering
[MEAS] Standards, Units, Metrology & Testing
[MILI] Military Technology
[MINE] Mining, Oil & Gas Extraction & Minerals
[SPRT] Sports, Leisure, Tourism & Hospitality Ind

Expand Synonyms

Back

Drones on CLIR (2)



PATENTSCOPE

Mobile | Deutsch | Español | Français | 日本語 | 한국어 | Português | Русский | 中文 | العربية

Search International and National Patent Collections

WORLD INTELLECTUAL PROPERTY ORGANIZATION

Search Browse Translate Options News Login Help

Home > IP Services > PATENTSCOPE

WIPO Translate

Input search terms

WIPO Pearl

Term 1: drone

Variants Domains [AERO,MEAS,MILI,SPRT]

Keep term untranslated when expanding query in other languages

Less | 0 | 4 | More

- unmanned aerial vehicles
- slow
- uav
- radio aircraft
- slowly
- low lightweight
- low down value

Add Variant

Translate Selected Terms

Back

Start Over



PATENTSCOPE

Mobile | Deutsch | Español | Français | 日本語 | 한국어 | Português | Русский | 中文 | العربية

Search International and National Patent Collections

WORLD INTELLECTUAL PROPERTY ORGANIZATION

Search Browse Translate Options News Login Help

Home > IP Services > PATENTSCOPE

WIPO Translate

WIPO Pearl

[Help]

English German Spanish French Italian Japanese Korean Portuguese Russian Chinese IPC

"drone" OR "unmanned aerial vehicles" OR "uav"

Field(s) you want to search:

Abstract

Acceptable distance between matched words:

Sentence

Stemming

Submit Query

Back

Start Over



Search results including all variations and translation of variations



PATENTSCOPE

Mobile | Deutsch | Español | Français | 日本語 | 한국어 | Português | Русский | 中文 | العربية |

Search International and National Patent Collections

WORLD INTELLECTUAL PROPERTY ORGANIZATION

Search Browse Translate Options News Login Help

Home > IP Services > PATENTSCOPE

Results 1-10 of 171,022 for Criteria:FP:(EN_AB:("drone" OR "unmanned aerial vehicles" OR "uav") OR DE_AB:("Drohne" OR "Gondel" OR "Drone" OR "UAV" OR "unbemannten Flugkörpern" OR "Flugkörpers" OR "Bordmanipulator" OR "Klein Flugkörper" OR "unbemannter Flugobjekte" OR "Durch") OR ES_AB:("drone" OR "aeronave remolcada" OR "avión sin piloto" OR "avión telecontrolado" OR "vehículos aéreos no tripulados") OR FR_AB:("drone" OR "uav" OR "téléguide sur piste" OR "avion sans pilote" OR "véhicules aériens sans pilote" OR "lente" OR "robots" OR "véhicules aériens sans équipage" OR "véhicules aériens télépilotes" OR "véhicules aériens non habités") OR IT_AB:("drone") OR JA_AB:("uav" OR "無人機特") OR KO_AB:("적응함수 근사화를" OR "무인항공기의") OR PT_AB:("veículos aéreos" OR "veículo" OR "veículos identificados tripulação") OR RU_AB:("задач" OR "беспилотного летательного аппарата" OR "беспилотный" OR "бортовых") OR ZH_AB:("无人驾驶飞机" OR "无人机" OR "靶标" OR "驾驶" OR "uav" OR "估算无人机" OR "无人机协同") AND ICF:(A63 OR B64 OR C06B OR C06C OR C06D OR C12Q OR F16 OR F41B OR F4? OR G01 OR G05 OR G12)) Office(s):all Language:EN Stemming: true



prev 1 2 3 4 5 6 7 8 9 10 next Page: 1 / 17103 Go >

Refine Search FP:(EN_AB:("drone" OR "unmanned aerial vehicles" OR "uav") OR

Search

RSS



Analysis

Sort by: Relevance View All List Length 10 Machine translation

Int.Class	Appl.No	Title	Applicant	Ctr	PubDate
G01N 21/88	201210165493.5	1. 102798635 Method to inspect components of wind turbine		CN	28.11.2012

The invention relates to a method to inspect components of a wind turbine. An unmanned aerial vehicle (UAV) is guided to the component for the inspection. A certain predefined distance between the unmanned aerial vehicle and the component is chosen in a way that high resolution images (IMG 1-IMG 9) of the component are gathered by the unmanned aerial vehicle (UAV). The images are gathered by an image acquisition system (IAS). The inspection is done remote controlled and based on the images, which are gathered by the unmanned aerial vehicle.

An example of a PCT document



PATENTSCOPE

Mobile | Deutsch | Español | Français | 日本語 | 한국어 | Português | Русский | 中文 | العربية |

Search International and National Patent Collections

WORLD INTELLECTUAL PROPERTY ORGANIZATION

Search Browse Translate Options News User: ikitsara@gmail.com Help

Home > IP Services > PATENTSCOPE

Machine translation

1. (WO2016161426) SYSTEMS AND METHODS FOR CONTROLLING PILOTLESS AIRCRAFT

PCT Biblio. Data Description Claims National Phase Notices Drawings Documents

Latest bibliographic data on file with the International Bureau [Submit observation](#)

PermaLink

Pub. No.: WO/2016/161426 International Application No.: PCT/US2016/025877

Publication Date: 06.10.2016 International Filing Date: 04.04.2016

IPC: B64C 19/00 (2006.01), B64C 39/02 (2006.01), G05D 1/00 (2006.01), G05D 1/10 (2006.01)

Applicants: 3D ROBOTICS, INC. [US/US]; 1608 4th Street, Suite 410 Berkeley, CA 94710 (US)

Inventors: SHORT, Jason, Edward; (US).
MERRILL, David, J.; (US).
LIAO, Eric, W.; (US).
KALANITHI, Jeevan, James; (US).
LOEHR, Kellyn; (US).
GUINN, Colin, A.; (US)

Agent: GLENN, W., Benjamin; (US)

Priority Data: 62/142,921 03.04.2015 US

Title (EN) SYSTEMS AND METHODS FOR CONTROLLING PILOTLESS AIRCRAFT
(FR) SYSTÈMES ET PROCÉDÉS DE COMMANDE DE VÉHICULE AÉRIEN SANS PILOTE

Abstract: (EN) A pilotless aircraft is provided which can include any number of features. In one embodiment, the aircraft includes a flight controller configured to establish first and second endpoints representing first and second absolute positions in space, constrain movement of the pilotless aircraft to a straight or curved path between the first and second endpoints, receive input from a user of the pilotless aircraft to move the pilotless aircraft forwards or backwards along the straight or curved path between the first and second endpoints, and receive input from the user to independently control an orientation of the camera.

(FR) L'invention concerne un véhicule aérien sans pilote qui peut comprendre un nombre quelconque de caractéristiques. Dans un mode de réalisation, le véhicule aérien comprend un dispositif de commande de vol conçu pour établir des premier et second points d'extrémité représentant des première et seconde positions absolues dans l'espace, pour limiter le déplacement du véhicule aérien sans pilote à une trajectoire droite ou incurvée entre les premier et second points d'extrémité, pour recevoir une entrée en provenance d'un utilisateur du véhicule aérien sans pilote de afin de déplacer le véhicule aérien sans pilote vers l'avant ou vers l'arrière le long de la trajectoire droite ou incurvée entre les premier et second points d'extrémité, et pour recevoir une entrée en provenance de l'utilisateur afin de commander indépendamment une orientation de la caméra.

Designated States: AE, AG, AL, AM, AO, AT, AU, AZ, BA, BB, BG, BH, BN, BR, BW, BY, BZ, CA, CH, CL, CN, CO, CR, CU, CZ, DE, DK, DM, DO, DZ, EC, EE, EG, ES, FI, GB, GD, GE, GH, GM, GT, HN, HR, HU, ID, IL, IN, IR, IS, JP, KE, KG, KN, KP, KR, KZ, LA, LC, LK, LR, LS, LU, LY, MA, MD, ME, MG, MK, MN, MW, MX, MY, MZ, NA, NG, NI, NO, NZ, OM, PA, PE, PG, PH, PL, PT, QA, RO, RS, RU, RW, SA, SC, SD, SE, SG, SK, SL, SM, ST, SV, SY, TH, TJ, TM, TN, TR, TT, TZ, UA, UG, US, UZ, VC, VN, ZA, ZM, ZW.
African Regional Intellectual Property Organization (BW, GH, GM, KE, LR, LS, MW, MZ, NA, RW, SD, SL, ST, SZ, TZ, UG, ZM, ZW)
Eurasian Patent Organization (AM, AZ, BY, KG, KZ, RU, TJ, TM)
European Patent Office (AL, AT, BE, BG, CH, CY, CZ, DE, DK, EE, ES, FI, FR, GB, GR, HR, HU, IE, IS, IT, LT, LU, LV, MC, MK, MT, NL, NO, PL, PT, RO, RS, SE, SI, SK, SM, TR)



WIPO Translation Tools



PATENTSCOPE

Mobile | Deutsch | Español | Français | 日本語 | 한국어 | Português | Русский | 中文 | العربية |

Search International and National Patent Collections

WORLD INTELLECTUAL PROPERTY ORGANIZATION

Search | Browse | Translate | Options | News | Login | Help

Home > IP Services > PATENTSCOPE

Machine translation

2. (CN204423159) Novel universal obstacle avoiding module for drone

National Biblio. Data | Description | Claims | Drawings | Documents

Note: Text based on automatic Optical Character Recognition processes. Please use the PDF version for legal matters

权利要求书

1.一种新型无人机通用避障模块，其特征是，由距离传感器，惯性传感器、单片机以及无线通信模块组成；其连接结构为：距离传感器，惯性传感器、无线通信模块、分别连接单片机；单片机还分别连接无人机飞控、遥控接收机；其中，距离传感器用于探测无人机与障碍物之间的距离，惯性传感器用于补偿因无人机飞行时的倾斜而引起的距离误差，无线通信模块负责传输无人机的飞行状态，单片机用于数据的处理。

Machine translation

- Wipo Translate ▶
- Google Translate
- Bing/Microsoft Translate
- Baidu Translate ▶

WIPO Translate – statistical machine translation



TRANSLATE

Instant patent translation

[English](#) | [Español](#) | [Français](#) | [中文](#) |

[Home](#) [IP Services](#) [PATENTSCOPE](#) [Database Search](#) [WIPO translate](#)

Translate

[\[help/user guide\]](#)

WIPO Translate is a powerful tool trained specifically to translate patent texts.

(It is not adapted for non-patent translations)

Cut and paste text from any patent document into the box below and select from the available language pairs.

Text to be translated:

Language pair:

Technical domain:

Translate

Related links

- [WIPO Translate Beta, featuring neural translation technology \(Chinese to English\)](#)

WIPO Translation beta version

patentscope.wipo.int/translate/demoNmt.jsf



TRANSLATE

Instant patent translation

[English](#) | [Español](#) | [Français](#) | [中文](#) |

[Home](#) | [IP Services](#) | [PATENTSCOPE](#) | [Database Search](#) | [WIPO translate](#)

Translate

[\[help/user guide\]](#)

WIPO Translate Beta is a powerful instant translation tool, designed specifically to translate patent texts (currently Chinese to English only). Simply cut and paste text from any Chinese patent document into the box below, then click on “Translate” to get an English translation ([examples of Chinese patent documents from PATENTSCOPE](#)).

This beta version WIPO Translate (Chinese to English) is currently being piloted. Please bear with us if you receive any errors related to capacity issues – we’re currently working on increasing our server power.

Text to be translated:

Translate

Related links

- [WIPO Translate full version \(all language pairs\)](#)
- [WIPO Develops Cutting-Edge Translation Tool For Patent Documents](#)

New PATENTSCOPE feature: Chemical compound search

The screenshot displays the WIPO PATENTSCOPE interface. At the top left is the WIPO logo, and to its right is the text 'PATENTSCOPE' and 'Search International and National Patent Collections'. A navigation bar includes 'Search', 'Browse', 'Translate', 'Options', 'News', 'User: ikitsara@gmail.com' (highlighted with a red box), and 'Help'. A dropdown menu is open under 'Search', with 'Chemical compounds' highlighted in a red box. Other menu items include 'Simple', 'Advanced Search', 'Field Combination', and 'Cross Lingual Expansion'. Below the menu is a search input field with a 'Front Page' dropdown on the left and 'Office: All' and a 'Search' button on the right. The main content area contains a blue header bar and a text block: 'on patent documents including 3 million published international patent applications (PCT). Detailed coverage'. At the bottom, there are two informational boxes: one with an 'i' icon and the text 'New Chemical Structure Search functionality', and another with an 'i' icon and the text 'PCT Publication 43/2016 (2016/10/27) is now available. The next publication date is scheduled as follows: Gazette number 44/2016 (2016/11/03). More'.

Chemical Compound Search

WIPO PATENTSCOPE

Search International and National Patent Collections

WORLD INTELLECTUAL PROPERTY ORGANIZATION

Mobile | Deutsch | Español | Français | 日本語 | 한국어 | Português | Русский | 中文 | العربية

Search | Browse | Translate | Options | News | User: ikitsara@gmail.com | Help

Home > IP Services > PATENTSCOPE

Chemical compounds search [Help]

Structure editor | Convert structure | Upload structure

Search | Reset

Search for scaffold: Office: All Specify ⇌

Draw or edit:

- ✓ Chemical structures
- ✓ Reactions
- ✓ Fragments similar to chemical sketches on paper;

Convert structure

WIPO PATENTSCOPE
Search International and National Patent Collections

Mobile | Deutsch | Español | Français | 日本語 | 한국어 | Português | Русский | 中文 | العربية

WORLD INTELLECTUAL PROPERTY ORGANIZATION

Search Browse Translate Options News User: ikitsara@gmail.com Help

Home > IP Services > PATENTSCOPE

Chemical compounds search [Help]

Structure editor **Convert structure** Upload structure

Compound name ▼ Type an accepted name, commercial name, CAS name, IUPAC name

Compound name
INN
InChI
SMILES

Search for scaffold: All Specify ⇌

Search Show in editor Reset

Tooltip Help

- PCT applications in EN and DE since 1978
- US national collection since 1979
- IUPAC/clinical/chemical/commercial names/CAS number/SMILES supported
- Exact compounds can be searched – no Markush structures supported

Convert structure example



PATENTSCOPE

Mobile | Deutsch | Español | Français | 日本語 | 한국어 | Português | Русский | 中文 | العربية |

Search International and National Patent Collections

WORLD INTELLECTUAL PROPERTY ORGANIZATION

Search

Browse

Translate

Options

News

User: ikitsara@gmail.com

Help

Home > IP Services > PATENTSCOPE

Chemical compounds search

[Help]

Structure editor

Convert structure

Upload structure

Compound name



Ritonavir

Search

Show in editor

Reset

Search for scaffold:

Office: All Specify

Tooltip Help

...and search for the chemical structure



WORLD INTELLECTUAL PROPERTY ORGANIZATION

Search Browse Translate Options News User: ikitsara@gmail.com Help

Home > IP Services > PATENTSCOPE

Chemical compounds search [\[Help\]](#)

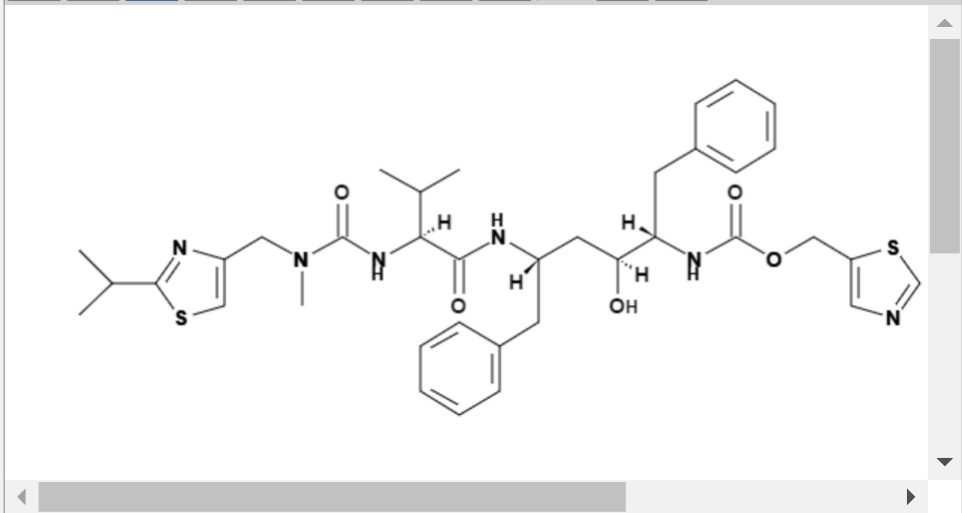
Structure editor Convert structure Upload structure



InChI: InChI=1S/C37H48N6O5S2/c1-24(2)33(42-36(46)43(5)20-29-22-49-35(40-29)25(3)4)34(45)39-28(16-26-12-8-6-9-13-26)18-32(44)31(17-27-14-10-7-11-15-27)41-37(47)48-21-30-19-38-23-50-30/h6-15,19,22-25,28,31-33,44H,16-18,20-21H2,1-5H3,(H,39,45)(H,41,47)(H,42,46)/t28-,31-,32-,33-/m0/s1

InChIKey: NCDNCNXCDXHOMX-XGKFQTDJSA-N

Molecular C37H48N6O5S2

Formula:

Molecular Weight 720.9572 g/mol

Weight:

Search Reset



Upload structure



PATENTSCOPE

Mobile | Deutsch | Español | Français | 日本語 | 한국어 | Português | Русский | 中文 | العربية |

Search International and National Patent Collections

WORLD INTELLECTUAL PROPERTY ORGANIZATION

Search

Browse

Translate

Options

News

User: ikitsara@gmail.com

Help

Home > IP Services > PATENTSCOPE

Chemical compounds search

[Help]

Structure editor

Convert structure

Upload structure

Select a structure file (MOL) or image file (PNG, GIF, TIFF, JPEG) and upload it.

Choose File No file chosen

Show in editor

Reset

Search for scaffold:

Office: All Specify ⇌

Tooltip Help

National phase and other available information



PATENTSCOPE

Mobile | Deutsch | Español | Français | 日本語 | 한국어 | Português | Русский | 中文 | العربية

Search International and National Patent Collections

WORLD INTELLECTUAL PROPERTY ORGANIZATION

Search | Browse | Translate | Options | News | Login | Help

Home > IP Services > PATENTSCOPE

Machine translation

169. (WO2012065681) AUTOMATED LANDING OF UNMANNED AERIAL VEHICLES

PCT Biblio. Data | Description | Claims | **National Phase** | Notices | Drawings | Documents

Available information on National Phase entries([more information](#))

Office	Entry Date	National Number	National Status
European Patent Office	22.04.2013	2011775741	Published: 25.09.2013

Legal status information and how WIPO helps accessing such information

- Legal status data essential for certain types of analysis (FTOs, portfolio analysis, CI/BI)
- Challenge of accessing relevant and up-to date legal status information
- Need to access the primary source of legal status information - Patent Registers/Gazettes for most up-to-date information
- In the context of the Development Agenda Project “IP and the Public Domain”, WIPO prepared a feasibility study on availability, reliability and comparability of patent legal status data (http://www.wipo.int/patentscope/en/programs/legal_status)
- Portal to national patent registers – pilot project
- Towards the development of a new standard: the work of the Legal Status Task Force of the CWS (http://www.wipo.int/edocs/mdocs/cws/en/cws_4_bis/cws_4_bis_5.pdf)

Patent Register Portal

World Intellectual Property Organization [CH] <https://patentscope.wipo.int/search/en/search.jsf>



PATENTSCOPE

Search International and National Patent Collections

Mobile | Deutsch | Español | Français | 日本語 | 한국어 | Português | Русский | 中文 | العربية

WORLD INTELLECTUAL PROPERTY ORGANIZATION

Search | Browse | Translate | Options | News | Login | Help

Home > IP Services

Simple Search

Using PATENTSCOPE information can help you find patents including 2.9 million published international patent applications (PCT). Detailed coverage

Browse by Week (PCT)

Sequence listing

IPC Green Inventory

Portal to patent registers

Front Page

Office: All

Search

PCT Publication 15/2016 (2016/04/14) is now available. The next publication date is scheduled as follows: Gazette number 16/2016 (2016/04/21). [More](#)

Patent Register Portal



Patent Register Portal

The portal aims to facilitate the verification of legal status of patents and related SPCs by compiling relevant information of national registers of various jurisdictions, e.g. availability of online access to a national or regional register. Please see the [Quick Help](#) for how to use this page, and the [User Guide](#) for detailed information about the page and the portal project. To access a register online, please click on the respective Y in the column 'Online National Register'. The boundaries and names shown and the designations used on this map do not imply official endorsement or acceptance by WIPO.

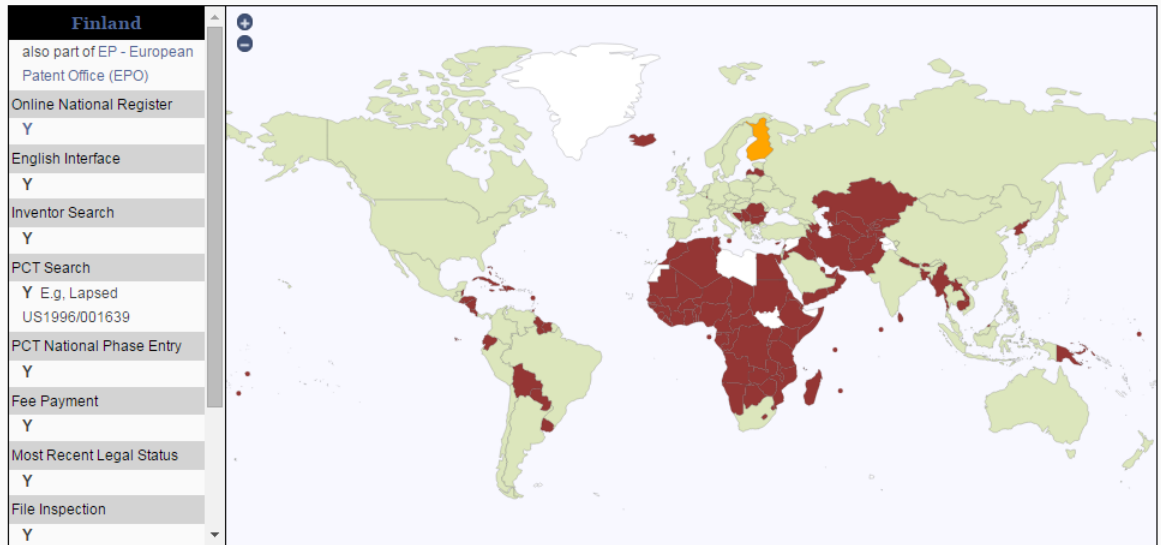

Jurisdiction	Online National Register	English Interface	Inventor Search	PCT Search	PCT National Phase Entry	Fee Payment	Most Recent Legal Status	File Inspection	SPCs	Full Publications	Online Gazette
EP - European Patent Office (EPO)	Y	Y	Y	Y	Y	Y	Y*	Y*	N/A	Y	Y*
ER - Eritrea	N	N/A	N/A	N/A*	N/A*	N/A	N/A	N/A	N/A	N	N
ES - Spain	Y	N	Y	Y*	Y	Y*	Y*	N	Y	Y	Y*
ET - Ethiopia	N	N/A	N/A	N/A*	N/A*	N/A	N/A	N/A	N/A	N	N
FI - Finland	Y	Y	Y	Y*	Y	Y	Y	Y	Y	Y	Y*
FR - France	Y*	Y	Y	N*	N	Y	Y*	N	Y	Y	Y*

Information on availability of online patent registers/Gazettes, search modalities, links & tips on searching for legal status in various patent registers

Color code:

Green: available

Red: not available

Online National Register	English Interface	Inventor Search	PCT Search	PCT National Phase Entry	Fee Payment	Most Recent Legal Status	File Inspection	SPCs	Full Publications	Online Gazette
--------------------------	-------------------	-----------------	------------	--------------------------	-------------	--------------------------	-----------------	------	-------------------	----------------

Patents and the Public Domain: Future developments

- New Development Agenda Project on the “*Use of information in the public domain for economic development*” (approved by the CDIP in April 2016)
- Project outputs:
 - Practical guides on the identification and use of inventions in the public domain
 - Documentation of experiences and best practices in the identification and use of inventions in the public domain
 - New and enhanced training materials for TISCs
 - Roster of experts on identification and use of inventions in the public domain
 - **Improved Patent Register Portal**

PATENTSCOPE: learning resources

Video tutorials

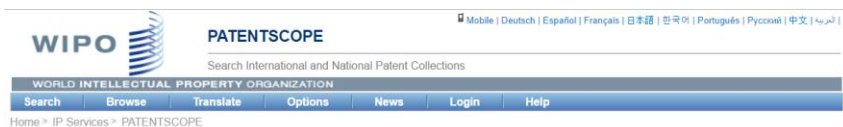

Tutorials

1. Introduction What is PATENTSCOPE, what is included in its database and how to access it. 	2. Browse Option In this video, you will learn how to use the "Browse by week", "Sequence listing", "IPC Green Inventory" and the "Register Portal" options. 	3. Simple Search The Simple search is the PATENTSCOPE default interface that contains 8 predefined search fields.
4. Field Combination The Field Combination interface enables you to combine many different predefined search fields. Search using specific search criteria in any of the search fields available. 	5. Advanced search The Advanced Search interface can be used to create complex search queries using an unlimited number of search terms. 	6. Search result list You will learn how to read the search result list.

Webinars

Register for upcoming webinars

- Options & Help menus in details
October 25 | October 27
- Complex queries
November 22 | November 24
- Retrospective of 2016 and plans for 2017
December 6 | December 8

Past events

Title	Description	Date
Chemical structure search PPT	How to use the chemical structure search in PATENTSCOPE	September 2016
IPC & PATENTSCOPE PPT	How to do make the most of the IPC in PATENTSCOPE	August 2016
The Browse menu in PATENTSCOPE PPT	Find out the different features offered in the PATENTSCOPE Browse menu	July 2016
Translation Tools in PATENTSCOPE PPT	Demonstration of the use of the different translation tools available in PATENTSCOPE	June 2016

<http://www.wipo.int/patentscope/en>

Global Brand Database

- Over 27,5 million records relating to nationally and internationally-protected trademarks
- Allows searches across multiple collections, including:
 - Trademarks registered under Madrid System and EUIPO
 - Appellations of Origin registered under Lisbon System
 - Emblems protected under the Paris Convention 6ter
 - 31 national collections, with more to come soon

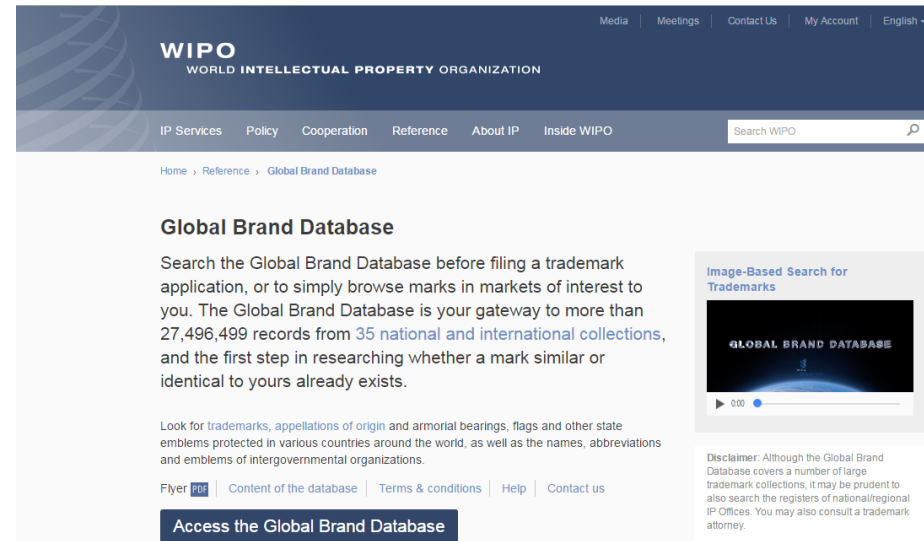

The screenshot shows the WIPO Global Brand Database website. The header features the WIPO logo and navigation links for Media, Meetings, Contact Us, My Account, and English. Below the header is a search bar and a menu with links for IP Services, Policy, Cooperation, Reference, About IP, and Inside WIPO. The main content area is titled "Global Brand Database" and includes a search bar, a video player for "Image-Based Search for Trademarks", and a disclaimer. A button labeled "Access the Global Brand Database" is prominently displayed.

WIPO
WORLD INTELLECTUAL PROPERTY ORGANIZATION

Media Meetings Contact Us My Account English

IP Services Policy Cooperation Reference About IP Inside WIPO Search WIPO

Home Reference Global Brand Database

Global Brand Database

Search the Global Brand Database before filing a trademark application, or to simply browse marks in markets of interest to you. The Global Brand Database is your gateway to more than 27,496,499 records from 35 national and international collections, and the first step in researching whether a mark similar or identical to yours already exists.

Look for trademarks, appellations of origin and armorial bearings, flags and other state emblems protected in various countries around the world, as well as the names, abbreviations and emblems of intergovernmental organizations.

Flyer PDF Content of the database Terms & conditions Help Contact us

[Access the Global Brand Database](#)

Image-Based Search for Trademarks

GLOBAL BRAND DATABASE

Disclaimer: Although the Global Brand Database covers a number of large trademark collections, it may be prudent to also search the registers of national/regional IP Offices. You may also consult a trademark attorney.

Global Brand Database

www.wipo.int/branddb/en/

WIPO WORLD INTELLECTUAL PROPERTY ORGANIZATION

Contact Us | My account | English

Home | Reference | Global Brand Database

searches records help

Global Brand Database

Perform a trademark search by text or image in brand data from multiple national and international sources, including trademarks, appellations of origin and official emblems. V: 2016-10-27 14:46

Data from Spain available 2016-10-11 Over 740,000 records added

Data from Mongolia available 2016-08-10 Over 15,000 records added

Data from Malaysia available 2016-07-05 Over 450,000 records added

Data from Jordan available 2016-05-17 Over 58,000 records added

Data from Georgia available 2016-04-15 Over 26,000 records added

NEWS available Over 20

SEARCH BY

Brand Names Numbers Dates Class Country

Text = e.g. wipo OR ompi, *ntel*, ompi-

Image Class = e.g. 05.07.13, apple AND tree

Goods (All) = e.g. footwear, comput*

search

FILTER BY

Source Image Status Origin App. Year * Expiration *

AE TM	39,540	AU TM	1,543,915	BN TM	42,497	CA TM	1,480,744
CH TM	376,204	DE TM	1,886,435	DK TM	284,437	DZ TM	27,072
EE TM	56,659	EG TM	109,441	EM TM	1,374,397	ES TM	745,119
GE TM	27,733	ID TM	811,878	IL TM	254,656	LA TM	37,897
JO TM	61,490	JP TM	1,931,509	KH TM	72,816	KR TM	3,176,094
MA TM	135,386	MD TM	37,219	MN TM	15,917	MX TM	1,148,392

Display: List Sort: Value - asc filter

1 - 30 / 27,501,527 TMview

Display: 30 per page options

Brand	Source	Status	Relevance	Origin	Holder	Number	App. Date	Image Class	Nice Cl.	Image
SONO MUSIC	EM TM	Pending	1	EM	SJRM Entertainment V.O.F.	015977762	2016-10-26		9, 41	
HI POP	EM TM	Pending	1	EM		015977705	2016-10-26		20, 35	
IL SALSICCIO	EM TM	Pending	1	EM	GRANDI SALUMIFICI ITALIANI S.p.A.	015977754	2016-10-26		29	
FLAGSHIP	EM TM	Pending	1	EM	SYNGENTA PARTICIPATIONS AG	015977713	2016-10-26		5	
ICON	EM TM	Pending	1	EM	Syngenta Limited	015977796	2016-10-26		5	

Global Brand DB and



Global Brand Database Perform a trademark search by text or image in brand data from multiple national and international sources, including trademarks, appellations of origin and official emblems. V: 2016-11-01 08:40

searches records help

Data from Spain available 2016-10-11 Over 740,000 records added
 Data from Mongolia available 2016-08-10 Over 15,000 records added
 Data from Malaysia available 2016-07-05 Over 450,000 records added
 Data from Jordan available 2016-05-17 Over 58,000 records added
 Data from Georgia available 2016-04-27 Over 26,000 records added
 Data from Papua New Guinea available 2016-04-27 Over 23,000 records added

SEARCH BY Brand Names Numbers Dates Class Country

Text = e.g. wipo OR ompi, *ntel*, ompi-

Image Class = e.g. 05.07.13, apple AND tree

Goods (All) = e.g. footwear, comput*

search

CURRENT SEARCH BRAND:wd40

FILTER BY Source Image Status Origin App. Year * Expiration *

AE TM	0	AU TM	1	Danish Trademarks	CA TM	10
CH TM	8	DE TM	5	DK TM	DZ TM	1
EE TM	1	EG TM	3	EM TM	ES TM	3
GE TM	2	ID TM	9	IL TM	LA TM	3
JO TM	2	JP TM	250	KH TM	KR TM	11
MA TM	1	MD TM	5	MN TM	MX TM	26

Display: List Sort: Value - asc filter

1 - 30 / 520 TMview

Display: 30 per page options

Brand	Source	Status	Relevance	Origin	Holder	Number	App. Date	Image Class	Nice Cl.	Image
WD-40 SPECIALIST	JP TM	Active	15	JP	ダブリュー・ディー・40・マニファクチャリング・カンパニー	5666891	2013-07-16		1, 2, 3, 4	
WD-40 HANDY PEN	JP TM	Active	15	JP	ダブリュー・ディー・40・マニファクチャリング・カンパニー	5024446	2006-02-27		2, 4	
WD-40, BIKE	JP TM	Active	15	JP	ダブリュー・ディー・40・マニファクチャリング・カンパニー	5847035	2014-08-18	VC.25.03, VC.26.04, VC.27.05, VC.27.07, VC.29.01	2, 3, 4	
WD-40	KR TM	Active	10	KR	더블유디-포티 메뉴팩처링 컴파니	402012000025151	2012-04-17	VC.19.03, VC.26.04	4, 2	

Grid view – for a faster overview of the results

Home Reference Global Brand Database

searches records help

Global Brand Database

Perform a trademark search by text or image in brand data from multiple national and international sources, including trademarks, appellations of origin and official emblems. V: 2016-11-01 08:40

Data from Spain available 2016-10-11 Over 740,000 records added

Data from Mongolia available 2016-08-10 Over 15,000 records added

Data from Malaysia available 2016-07-05 Over 450,000 records added

Data from Jordan available 2016-05-17 Over 58,000 records added

Data from Georgia available 2016-04-27 Over 26,000 records added

Data from Papua New Guinea available Over 23,000 records added

NEWS

SEARCH BY

Brand Names Numbers Dates Class Country

Text = e.g. wipo OR ompi, *ntel*, ompi-

Image Class = e.g. 05.07.13, apple AND tree

Goods (All) = e.g. footwear, comput*

search

CURRENT SEARCH

BRAND:wd40

FILTER BY

Source	Image	Status	Origin	App. Year *	Expiration *
AE TM	0	AU TM	25	BN TM	3
CA TM				CH TM	10
CH TM	8	DE TM	5	DK TM	3
DZ TM				EE TM	3
EE TM	1	EG TM	3	EM TM	21
ES TM				GE TM	3
GE TM	2	ID TM	9	IL TM	6
LA TM				JO TM	3
KR TM				JP TM	250
KR TM				MA TM	1
MX TM				MD TM	5
MN TM					0

Display: List Sort: Value - asc filter

1 - 30 / 520 TMview

Display: 30 per page options

Sort by Relevance - desc

1 - 30 / 520

Geographical distribution of WD-40 trademarks

WD-40 as TM holder

WD-40 as brand

Home Reference Global Brand Database

Global Brand Database

Perform a trademark search by text or image in brand data from multiple national and international sources. Appellations of origin and official emblems. V: 2016-11-01 08:40

Data from Spain available 2016-10-11 Over 740,000 records added | Data from Mongolia available 2016-08-10 Over 15,000 records added | Data from Malaysia available 2016-07-05 Over 450,000 records added | Data from Jordan available 2016-05-17 Over 58,000 records added | Data from Georgia available 2016-05-17 Over 26,000 records added

SEARCH BY

Brand Names Numbers Dates Class Country

Text = e.g. wipo OR omni, "intel", omni-

Image Class = e.g. 05.07.13, apple AND tree

Goods (All) = e.g. footwear, comput*

search

CURRENT SEARCH BRAND wd40

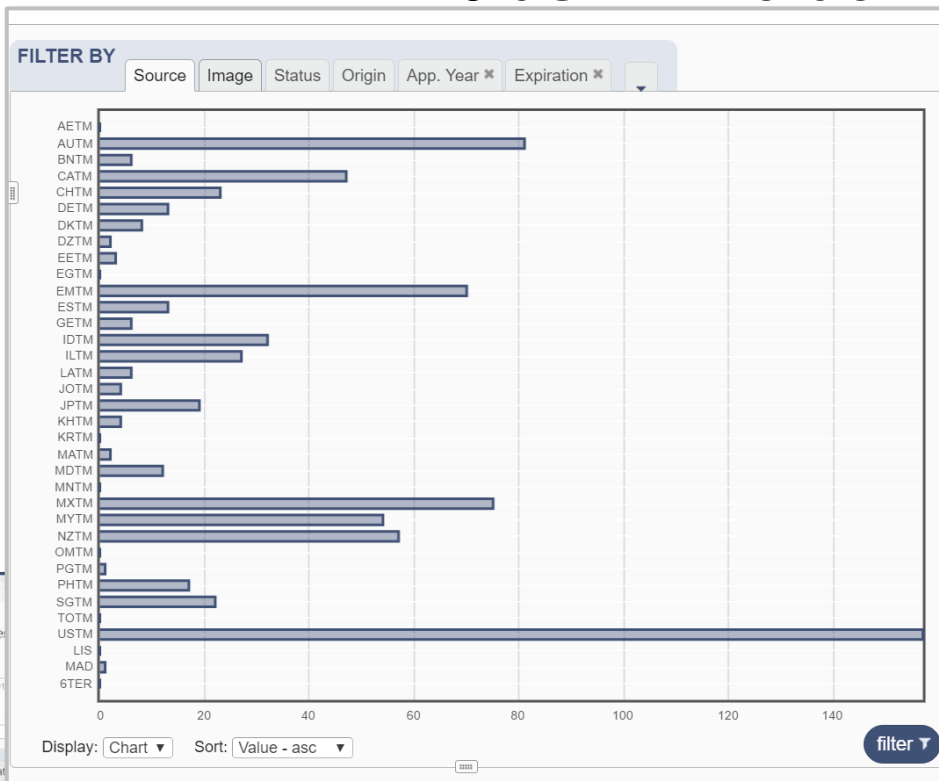
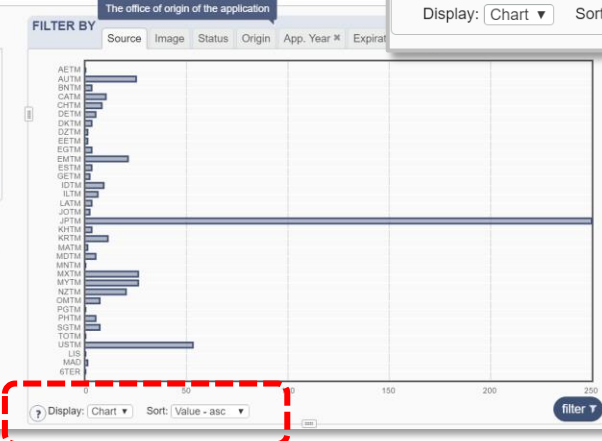

A database entry

WIPO WORLD INTELLECTUAL PROPERTY ORGANIZATION	Global Brand Database	International Trademark
1282614 - facebook		Printed: Thu, 27 Oct 2016 14:19:27 GMT
1282614 - facebook		
(151) Date of the registration 23.12.2014		
(180) Expected expiration date of the registration/renewal 23.12.2024		
(270) Language(s) of the application English		
(732) Name and address of the holder of the registration Facebook, Inc. 1601 Willow Road Menlo Park, CA 94025 (US)		
(811) Contracting State of which the holder is a national US		
(842) Legal nature of the holder (legal entity) and State, and, where applicable, the State in which the entity is organized Corporation, Delaware, United States		
(740) Name and address of the representative Anne H. Peck Cooley LLP 1299 Pennsylvania Avenue, Suite 700 Washington DC 20004 (US)		

(540) Mark



(531) International Classification of the Figurative Elements of Marks (Vienna Classification)- VCL (7)
27.05.24; 29.01.12.

(591) Information concerning colors claimed
White and blue. The word FACEBOOK in white letters with a blue background.

(571) Description of mark
The mark consists of the word FACEBOOK in white letters with a blue background.

(511) The International Classification of Goods and Services for the Purposes of the Registration of Marks (Nice Classification) and the list of goods and services classified according thereto- NCL (10-2014)

- 09 Computer software development tools; computer software for use as an application programming interface (API); application programming interface (API) for computer software which facilitates online services for social networking, building social networking applications and for allowing data retrieval, upload, download, access and management; computer software to enable uploading, downloading, accessing, posting, displaying, tagging, blogging, streaming, linking, sharing or otherwise providing electronic media or information via computer and communication networks.
- 35 Marketing, advertising and promotion services; market research and information services; advertising services, namely, promoting the goods and services of others via computer and communication networks; operating on-line marketplaces for sellers of goods and/or services; online retail store services featuring digital media, namely, pre-recorded digital sound, video and data recordings featuring music, text, video, games, comedy, drama, action, adventure or animation; charitable services, namely, promoting public awareness about charitable, philanthropic, volunteer, public and community service and humanitarian activities; compiling of information into computer databases.
- 36 Financial transaction processing services, namely, clearing and reconciling financial transactions via computer and communication networks; electronic funds transfer services; financial exchange services, namely, providing a virtual currency for use by members of an online community via computer and communication networks.
- 38 Providing access to computer databases in the fields of social networking, social introduction and dating; peer-to-

Search by representative

Global Brand Database

Perform a trademark search by text or image in brand data from multiple national and international sources, including trademarks, appellations of origin and official emblems. V: 2016-11-02 11:35

searches records help

Data from Spain available
Over 740,000 records added

2016-10-11

Data from Mongolia available
Over 15,000 records added

2016-08-10

Data from Malaysia available
Over 450,000 records added

2016-07-05

Data from Jordan available
Over 58,000 records added

2016-05-17

Data from Georgia available
Over 26,000 records added

NEWS

SEARCH BY

Brand Names Numbers Dates Class Country

Holder = e.g. "world intell*", wipo~

Representative = e.g. jones~, smith OR smythe

search

CURRENT SEARCH

REP:"Dorsey & Whitney LLP"

FILTER BY

Source Image Status Origin App. Year * Expiration *

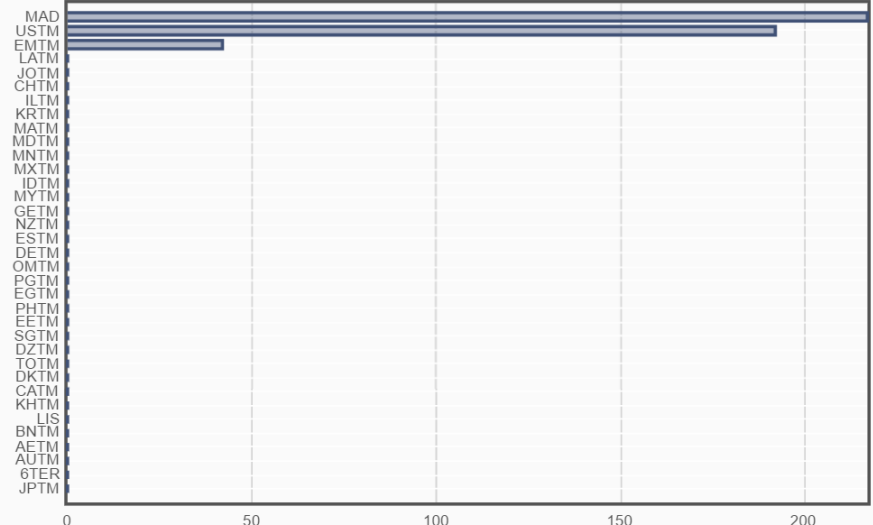

Display: Chart Sort: Count - desc

filter

Image similarity search feature

Global Brand Database

Perform a trademark search by text or image in brand data from multiple national and international sources, including trademarks, appellations of origin and official emblems. V: 2016-10-27 15:48

searches records help

Data from Spain available 2016-10-11 Over 740,000 records added

Data from Mongolia available 2016-08-10 Over 15,000 records added

Data from Malaysia available 2016-07-05 Over 450,000 records added

Data from Jordan available 2016-05-17 Over 58,000 records added

Data from Georgia available 2016-04 Over 26,000 records added

NEWS * available Over 2:

SEARCH BY

Brand Names Numbers Dates Class Country

Text = e.g. wipo OR ompi, *ntel*, ompi~

Image Class = e.g. 05.07.13, apple AND tree

Goods (All) = e.g. footwear, comput*

search

CURRENT SEARCH

BRAND:facebook *

FILTER BY

Source Image Status Origin App. Year * Expiration *

Pick an image

browse

or

drag an image here

Pick a strategy

Shape

Color

Texture

Composite

Pick an image type

Verbal 54

Nonverbal 2

Combined 160

Unknown 6

filter

1 - 30 / 447

TMview

Display: 30 per page options

1 / 15

	Brand	Source	Status	Relevance	Origin	Holder	Number	App. Date	Image Class	Nice Cl.	Image
	FACEBOOK	JP TM	Active	20	JP	フェイスブック・インコーポレイテッド	5576709	2012-04-04		16, 35, 40, 42, 45	FACEBOOK
	FACEBOOK	JP TM	Active	20	JP	フェイスブック・インコーポレイテッド	5586751	2012-04-04	VC.26.04	16, 35, 40, 42, 45	facebook
	FACEBOOK	JP TM	Active	20	JP	フェイスブック・インコーポレイテッド	5487959	2011-03-01		9, 16, 35, 36	FACEBOOK

Select your similarity search strategy

WIPO
WORLD INTELLECTUAL PROPERTY ORGANIZATION

Contact Us | My account | English ▾

Home | Reference | Global Brand Database

searches ▾ records ▾ help ▾

Global Brand Database

Perform a trademark search by text or image in brand data from multiple national and international sources, including trademarks, appellations of origin and official emblems. V: 2016-10-27 15:48

Data from Spain available 2016-10-11 Over 740,000 records added	Data from Mongolia available 2016-08-10 Over 15,000 records added	Data from Malaysia available 2016-07-05 Over 450,000 records added	Data from Jordan available 2016-05-17 Over 58,000 records added	Data from Georgia available 2016-04-11 Over 26,000 records added	NEWS ✕ available Over 2:
---------------------------------------------------------------------------	-----------------------------------------------------------------------------	------------------------------------------------------------------------------	---------------------------------------------------------------------------	----------------------------------------------------------------------------	---------------------------------------

SEARCH BY

Brand | Names | Numbers | Dates | Class | Country

Holder = e.g. "world intell", wipo~

Representative = e.g. jones~, smith OR smythe

search ↗

CURRENT SEARCH
HOL:facebook ✕

FILTER BY

Source | Image | Status | Origin | App. Year ✕ | Expiration ✕

Pick an image



delete 🗑

Pick a strategy

- Shape
- Color
- Texture**
- Composite

Pick an image type

Verbal	0
Nonverbal	0
Combined	353
Unknown	0

filter ↕

CURRENT FILTER
IMAGE:Texture ✕ ITY:Combined ✕

1 - 30 / 353

TMview ↗

Display: 30 per page options ⚙

Sort by Relevance - desc ▾



Define your search strategy and...

searches ▾ records ▾ help ▾

Global Brand Database

Perform a trademark search by text or image in brand data from multiple national and international sources, including trademarks, appellations of origin and official emblems. V: 2016-10-27 15:48

Data from Spain available 2016-10-11 Over 740,000 records added

Data from Mongolia available 2016-08-10 Over 15,000 records added

Data from Malaysia available 2016-07-05 Over 450,000 records added

Data from Jordan available 2016-05-17 Over 58,000 records added

Data from Georgia available 2016-04-27 Over 26,000 records added

Data from Papua New Guinea available 2016-04-27 Over 23,000 records added

NEWS ✕

SEARCH BY

Brand Names Numbers Dates Class Country

Text = e.g. wipo OR ompi, *intel*, ompi~

Image Class = e.g. 05.07.13, apple AND tree

Goods (All) = e.g. footwear, comput*

search ↗

CURRENT SEARCH

BRAND:starbucks ✕

FILTER BY

Source Image Status Origin App. Year ✕ Expiration ✕

Pick an image



delete

Pick a strategy

Shape

Color

Texture

Composite

Pick an image type

Verbal 0

Nonverbal 0

Combined 725





Unknown 0

filter ↕

CURRENT FILTER

IMAGE:Shape ✕ ITY:Combined ✕

1 - 30 / 725 1 / 25

Brand	Source	Status	Relevance	Origin	Holder	Number	App. Date	Image Class	Nice Cl.	Image
STARBUCKS COFFEE	JP TM	Active	5	JP	スターバックス・コーポレーション	5232548	2007-06-27	VC.01.01, VC.02.03, VC.04.02, VC.24.09, VC.26.01	35	
starbucks coffee	SG TM	Active	2	SG	STARBUCKS CORPORATION D/B/A STARBUCKS COFFEE COMPANY	T0516241J	2005-09-02		43	
starbucks coffee	SG TM	Active	2	SG	STARBUCKS CORPORATION D/B/A STARBUCKS COFFEE COMPANY	T0516238J	2005-09-02		30	
starbucks coffee	SG TM	Active	2	SG	STARBUCKS CORPORATION D/B/A STARBUCKS COFFEE COMPANY	T0516240B	2005-09-02		35	

Look for the Nice classification

(540) Mark



(532) Description of the figurative elements of the mark according to a national classification

01.01.03, 04.03.03, 24.11.02, 26.01.21.

(550) Indication relating to the nature or kind of mark

Trademark Service Mark

(571) Description of mark

The mark consists of a circular seal in green with the design of a siren (a two-tailed mermaid) in white wearing a crown.

(591) Information concerning colors claimed

The color(s) green and white is/are claimed as a feature of the mark.

(641) Number(s) and date(s) of other legally related applications

(US Registrations) 1542775; 1815937; 1815938; and others

(750) Address for correspondence

JULIA ANNE MATHESON, FINNEGAN, HENDERSON, FARABOW, GARRETT AN, 901 NEW YORK AVE NW, WASHINGTON, DC 20001-4432

(731) Name and address of the applicant

(Applicant) Starbucks Corporation (Also known as DBA Starbucks Coffee Company) Corporation WASHINGTON, 2401 Utah Avenue South, Seattle WA 98134

(732) Name and address of the holder of the registration

(Owner) Starbucks Corporation (Also known as DBA Starbucks Coffee Company) Corporation WASHINGTON, 2401 Utah Avenue South, Seattle WA 98134

(Registrant) Starbucks Corporation (Also known as DBA Starbucks Coffee Company) Corporation WASHINGTON, 2401 Utah Avenue South, Seattle WA 98134

(740) Name and address of the representative

(Attorney of Record) Julia Anne Matheson

(511) The International Classification of Goods and Services for the Purposes of the Registration of Marks (Nice Classification) and the list of goods and services classified according thereto

- 05 Nutritionally fortified beverages; meal replacement and dietary supplement drink mixes, nutritional supplements in the form of foods bars; powdered fruit-flavored dietary supplement drink mix; powdered nutritional supplement drink mix; and vitamin fortified beverages
- 09 Audio recordings featuring classical, jazz, contemporary, pop, seasonal, R and B, soul, world, zydeco, reggae, rock, folk and show tunes music; downloadable music via a global computer network and wireless devices; vending machines
- 11 Electrical appliances, namely, espresso makers and coffee makers for domestic or commercial use
- 16 Publications and printed materials, namely, newsletters and magazines featuring information about coffee and coffee drinkers, pens, ball point pens, stationery, posters, paper napkins, paper coasters, and paper bags
- 21 Hand operated coffee grinders and coffee mills, insulated coffee and beverage cups, non-paper coasters, insulated vacuum bottles, coffee cups, tea cups and mugs, glassware, dishes, plates and bowls, trivets, storage canisters, non-electric drip coffee makers, non-electric plunger-style coffee makers, and decorative storage containers for food, non-electric tea kettles, tea infusers, tea pots, tea strainers, ceramic figurines, porcelain figurines; paper cups and insulated sleeves for beverage cups
- 25 T-shirts, polo shirts, sweatshirts, caps, hats, jackets, shorts, and aprons
- 29 Milk, flavored milk, milkshakes and milk based beverages; fruit jams, jellies, spreads, and preserves
- 30 Ground and whole bean coffee, cocoa, herbal and non-herbal tea, coffee, tea, cocoa and espresso beverages, and beverages made with a base of coffee and/or espresso, beverages made with a base of tea, powdered chocolate; sauces to add to beverages; chocolate syrup, flavoring syrups to add to beverages, baked goods, namely, muffins, scones, biscuits, cookies, pastries and breads, sandwiches, granola, ready-to-drink coffee, ready-to-drink tea, and frozen confections; chocolate, candy and chocolate confections; and sauces
- 32 Water and other non-alcoholic drinks, namely, soft drinks, fruit drinks and fruit juices, fruit drinks and soft drinks containing fruit juices, powdered beverage mixes, flavoring syrups for making beverages, flavored and unflavored bottled waters, fruit juices, sparkling fruit and juice based beverages and soda beverages; frozen fruit beverages and frozen fruit-based beverages

And combine it with your image search strategy

www.wipo.int/branddb/en/#

Global Brand Database

Perform a trademark search by text or image in brand data from multiple national and international sources, including trademarks, appellations of origin and official emblems. V: 2016-10-27 15:48

Data from Spain available Over 740,000 records added	2016-10-11	Data from Mongolia available Over 15,000 records added	2016-05-10	Data from Malaysia available Over 450,000 records added	2016-07-05	Data from Jordan available Over 58,000 records added	2016-05-17	Data from Georgia available Over 26,000 records added	2016-04-27	Data from Papua New Guinea available Over 23,000 records added	2016-02-16	Reports v. NEWS PDF and HTML reports include embedded images
---------------------------------------------------------	------------	-----------------------------------------------------------	------------	------------------------------------------------------------	------------	---------------------------------------------------------	------------	----------------------------------------------------------	------------	-------------------------------------------------------------------	------------	--------------------------------------------------------------

SEARCH BY

Brand Names Numbers Dates Class Country

Text = e.g. wipo OR ompl, "intel", ompl-

Image Class = e.g. 05.07.13, apple AND tree

Goods (All) = e.g. footwear, comput*

search

FILTER BY

Source Image Status Origin App. Year Expiration

Pick an image:  delete

Pick a strategy:

- Shape
- Color
- Texture
- Composite

Pick an image type:

- Verbal 0
- Nonverbal 0
- Combined 8,011,697
- Unknown 0

filter

CURRENT FILTER: ITY: Combined IMAGE: Texture

1 - 100 / 8,011,697 TMview Display: 100 per page

Sort by Relevance - desc



...for more relevant results

WIPO
WORLD INTELLECTUAL PROPERTY ORGANIZATION

Contact Us | My account | English ▾

Home | Reference | Global Brand Database

searches ▾ records ▾ help ▾

Global Brand Database

Perform a trademark search by text or image in brand data from multiple national and international sources, including trademarks, appellations of origin and official emblems. V: 2016-10-27 15:48

Data from Spain available Over 740,000 records added 2016-10-11	Data from Mongolia available Over 15,000 records added 2016-08-10	Data from Malaysia available Over 450,000 records added 2016-07-05	Data from Jordan available Over 58,000 records added 2016-05-17	Data from Georgia available Over 26,000 records added 2016-04-27	Data from Papua New Guinea available Over 23,000 records added 2016-02-16	Reports w/ NEWS PDF and HTML reports include embedded images
-----------------------------------------------------------------------	-------------------------------------------------------------------------	--------------------------------------------------------------------------	-----------------------------------------------------------------------	------------------------------------------------------------------------	---------------------------------------------------------------------------------	-----------------------------------------------------------------

SEARCH BY

Brand | Names | Numbers | Dates | Class | Country

Text = e.g. wipo OR omp, *ntel*, omp-

Image Class = e.g. 05.07.13, apple AND tree

Goods (All) = e.g. footwear, comput*

search

CURRENT SEARCH
GS:coffee ✕

FILTER BY

Source | Image | Status | Origin | App. Year ✕ | Expiration ✕

Pick an image:  delete

Pick a strategy: Shape, Color, **Texture**, Composite

Pick an image type: Verbal 0, Nonverbal 0, **Combined 131,761**, Unknown 0

filter

CURRENT FILTER
ITY:Combined ✕ | IMAGE:Texture ✕

1 - 100 / 131,761 | TMview | Display: 100 per page options | 1 / 1,318

Sort by: Relevance - desc



Global Design Database

The screenshot shows the WIPO website header with navigation links: Media, Meetings, Contact Us, My Account, and English. Below the header is a search bar labeled 'Search WIPO'. The main content area features the title 'Global Design Database' and a description: 'Via a single, intuitive interface, the Global Design Database enables free, simultaneous searches of more than industrial designs registered under the WIPO-administered Hague System and/or in participating national collections.' A button labeled 'Access the Global Design Database' is prominently displayed. To the right, a 'Links' box contains 'Help' and 'Contact us'. Below this is a 'News' section with two items: 'WIPO adds more than 1 million new documents to Global Design Database' dated August 5, 2015, and 'Global Dissemination of IP Data Initiative' dated May 12, 2015. An 'All news' button is located at the bottom right of the news section.

<http://www.wipo.int/designdb>

- Launched in 2015
- Simultaneous search of more than 1,6 million industrial designs registered in the available national collections or under the Hague System

Global Design Database and



Global Design Database

A world-wide collection of industrial designs data; including WIPO Hague registrations and information from participating national offices.

SEARCH BY

Design Names Numbers Dates Country

Holder =

Creator =

Representative =

CURRENT SEARCH

FILTER BY

Source Designation Locarno Class Reg. Year ✕

CA Designs	121	ES Designs	17	JP Designs	1
NZ Designs	18	US Designs	683	WO Designs	55

Display: List Sort: Value - asc

	Reg. No	Source	Holder	Reg. Date	Locarno CI	National CI	Ind. Prod.	Designations	Designs	Image
<input type="checkbox"/>	D0752671	USID	GoPro, Inc.	2016-03-29	16-01	US.D16-200	Camera housing	US	1	
<input type="checkbox"/>	D0752672	USID	GoPro, Inc.	2016-03-29	16-01	US.D16-200	Camera housing	US	1	
<input type="checkbox"/>	D0751133	USID	GoPro, Inc.	2016-03-08	16-05	US.D16-219	Camera housing	US	1	
<input type="checkbox"/>	D0751131	USID	GoPro, Inc.	2016-03-08	16-01	US.D16-218	Camera	US	1	
<input type="checkbox"/>	D0751135	USID	GoPro, Inc.	2016-03-08	16-05	US.D16-237	Lens cover	US	1	

Geographical distribution of industrial designs portfolio

Global Design Database

A world-wide collection of industrial designs data; including WIPO Hague registrations and information from participating national offices.

SEARCH BY

Design | Names | Numbers | Dates | Country

Holder =

Creator =

Representative =

search 🔍



CURRENT SEARCH

HOL:go pro *



FILTER BY

Source | Designation | Locarno Class | Reg. Year *

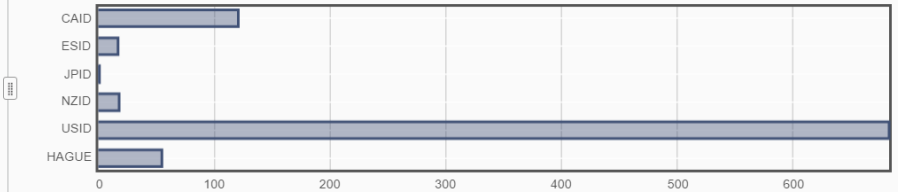

Display: Chart ▾ | Sort: Value - asc ▾

filter ▾

1 - 10 / 895

edit columns <>

10 ▾ per page

1 / 90

Reg. No	Source	Holder	Reg. Date	Locarno Cl	National Cl	Ind. Prod.	Designations	Designs	Image
D0752671	USID	GoPro, Inc.	2016-03-29	16-01	US.D16-200	Camera housing	US	1	
D0752672	USID	GoPro, Inc.	2016-03-29	16-01	US.D16-200	Camera housing	US	1	
D0751133	USID	GoPro, Inc.	2016-03-08	16-05	US.D16-219	Camera housing	US	1	
D0751131	USID	GoPro, Inc.	2016-03-08	16-01	US.D16-218	Camera	US	1	
D0751135	USID	GoPro, Inc.	2016-03-08	16-05	US.D16-237	Lens cover	US	1	

Registration strategy and age of portfolio

Global Design Database

A world-wide collection of industrial designs data; including WIPO Hague registrations and information from participating national offices.

SEARCH BY

Design | Names | Numbers | Dates | Country

Holder =

Creator =

Representative =

CURRENT SEARCH

FILTER BY

Source | Designation | Locarno Class | Reg. Year *

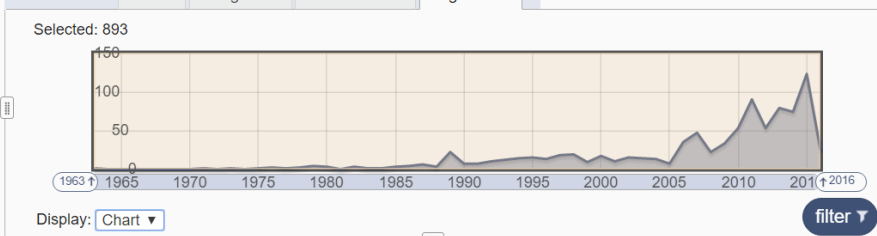

1 - 10 / 895 10 per page 1 / 90

	Reg. No	Source	Holder	Reg. Date	Locarno Cl	National Cl	Ind. Prod.	Designations	Designs	Image
<input type="checkbox"/>	D0752671	USID	GoPro, Inc.	2016-03-29	16-01	US.D16-200	Camera housing	US	1	
<input type="checkbox"/>	D0752672	USID	GoPro, Inc.	2016-03-29	16-01	US.D16-200	Camera housing	US	1	
<input type="checkbox"/>	D0751133	USID	GoPro, Inc.	2016-03-08	16-05	US.D16-219	Camera housing	US	1	
<input type="checkbox"/>	D0751131	USID	GoPro, Inc.	2016-03-08	16-01	US.D16-218	Camera	US	1	
<input type="checkbox"/>	D0751135	USID	GoPro, Inc.	2016-03-08	16-05	US.D16-237	Lens cover	US	1	

An example of a database entry

WIPO
WORLD INTELLECTUAL PROPERTY ORGANIZATION

Contact Us | My account | English ▾

Home | Reference | Global Design Database

Global Design Database

A world-wide collection of industrial designs data; including WIPO Hague registrations and information from participating national offices.

← back

4 / 895

US Industrial Design

To ensure the most reliable and accurate search results of U.S. applications and registrations, users - particularly those filing applications with the USPTO - should access the USPTO Patent Database at www.uspto.gov and search U.S. application and registration data using the available assisted search forms and other search tools available on the USPTO website.

D0751131 - Camera

(11) **International Registration Number**
D0751131

Filing Date of the Application
2014-12-16

(15) **Date of the international registration**
2016-03-08

(54) **Indication of products**
Camera

(51) **Class and subclass of the Locarno Classification**
16-01

(52) **National classification**
D16-218

(72) **Name and address of creator of designs**
[Inventor] Woodman; Nicholas D. (Sausalito, CA US)

(72) **Name and address of creator of designs**
[Inventor] Bould; Fred (Half Moon Bay, CA US)

(72) **Name and address of creator of designs**
[Inventor] Beck; Kristen (San Mateo, CA US)

(72) **Name and address of creator of designs**
[Inventor] Northway; David Christophe (San Carlos, CA US)

(72) **Name and address of creator of designs**
[Inventor] ... David Andrew (San Mateo, CA US)

(55) **Description of images**
FIG. 1 is a front, top and right side perspective view of a camera showing our new design;
FIG. 2 is a front, bottom and left side perspective view thereof;
FIG. 3 is a rear, top and left side perspective view thereof;
FIG. 4 is a rear, bottom and right side perspective view thereof;
FIG. 5 is a front elevational view thereof;
FIG. 6 is a rear elevational view thereof;
FIG. 7 is a right side elevational view thereof;
FIG. 8 is a left side elevational view thereof;
FIG. 9 is a top plan view thereof; and,
FIG. 10 is a bottom plan view thereof.
The broken lines depict portions of the camera in which the design is embodied and form no part of the claimed design.

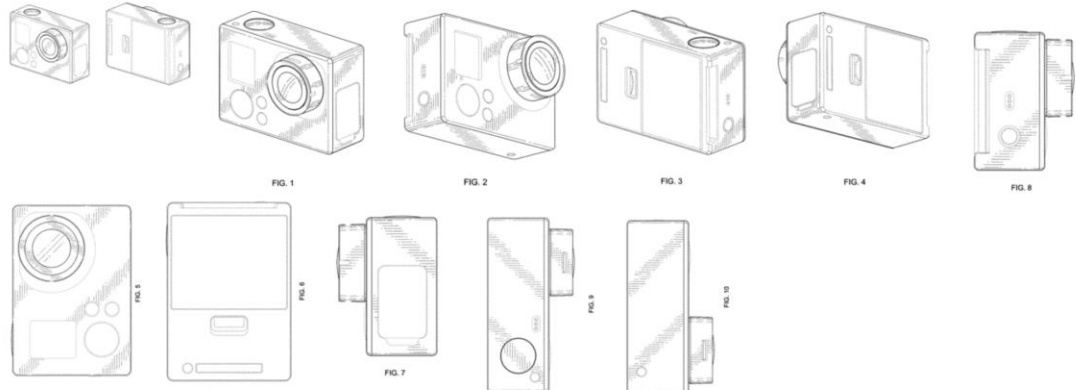

FIG. 1 FIG. 2 FIG. 3 FIG. 4 FIG. 5 FIG. 6 FIG. 7 FIG. 8 FIG. 9 FIG. 10

Search by national/Locarno Classification

Global Design Database

A world-wide collection of industrial designs data; including WIPO Hague registrations and information from participating national offices.

SEARCH BY

Design Names Numbers Dates Country

Indication of Products ▾ =

Design class ▾ =

Description ▾ =

CURRENT SEARCH
DC:16-01 ✕

FILTER BY

Source Designation Locarno Class Reg. Year ✕

CA Designs	0	ES Designs	38	JP Designs	5,468
NZ Designs	20	US Designs	2,725	WO Designs	90

Display: List ▾ Sort: Value - asc ▾

1 - 10 / 8,341 10 per page 1 / 835

Reg. No	Source	Holder	Reg. Date	Locarno Cl	National Cl	Ind. Prod.	Designations	Designs	Image
DM/092671	Hague	SAMSUNG ELECTRONICS CO., LTD	2016-09-22	16-01		1.-2. Cameras	EM	2	
1559824	JPID	キヤノ株式会社	2016-09-02	16-01	JP.J3-231, JP.J3-231B	デジタルカメラ	JP	1	
1559822	JPID	キヤノ株式会社	2016-09-02	16-01	JP.J3-231, JP.J3-231A	デジタル一眼レフカメラ	JP	1	
1559825	JPID	キヤノ株式会社	2016-09-02	16-01	JP.J3-231, JP.J3-231B	デジタルカメラ	JP	1	

Search by national/Locarno Classification



[Contact Us](#) | [My account](#)

Home
Reference
Global Design Database

Global Design Database

A world-wide collection of industrial designs data; including WIPO Hague registrations and information from participating national offices.

SEARCH BY

Design | Names | Numbers | Dates | Country

Indication of Products =

Design class =

Description =

search

FILTER BY

Source | Designation | Locarno Class | Reg. Year

CA Designs	157,875	ES Designs	96,234	JP Designs	509,968
NZ Designs	45,686	US Designs	751,450	WO Designs	46,274

1 - 10 / 1,607,487 edit columns <>

Reg. No	Source	Holder	Reg. Date	Locarno Cl	Name
422055	NZID	Scania CV AB	2016-10-26	12-16	Camera cases
422054	NZID	Scania CV AB	2016-10-26	12-16	Cine-camera cases

Lookup individual design classes

1 - 50 / 76 1 / 2

Description	Type	Code
Camera cases	LC	03-01
Cine-camera cases	LC	03-01
PHOTOGRAPHIC, VIDEO EQUIPMENT AND APPLIANCES cameras, lights and flash, photocopying machines	CA	084
Still-Picture Cameras	CA	084-02
Motion Picture Cameras	CA	084-03
Video Cameras, Motion-Picture Cameras, Camcorders, Home Movie (8mm) Cameras	CA	084-03-01
Camera Parts	CA	084-04
Cinematographic cameras	LC	16-01
Photographic cameras	LC	16-01
Surveillance cameras	LC	16-01
Television cameras	LC	16-01
Photographic cameras [digital/numerical]	LC	16-01
Stands for photographic or cinematographic cameras	LC	16-05

WIPO Digital Access System (DAS)

- DAS (Digital Access System) used by 14 IPOs
- A System that allows IPOs and applicants to securely exchange or submit a digital copy of priority documents to multiple IPOs

Participating Offices

The digital libraries of the following offices are participating in the WIPO Digital Document Access Service (DAS), established under the [Framework Provisions for the Digital Access Service](#).

There are two different types of notification possible:

- **Depositing Office** (paragraph 10 of the Framework Provisions): The Office, which is usually acting as the Office of first filing, allows applications to be made available to the Service;
- **Accessing Office** (paragraph 12 of the Framework Provisions): The Office, acting as an Office of second filing, allows the applicant to request that a priority document be retrieved from the Service instead of having to file a certified copy.

At present, the service is operational for patent documents only. One office is ready to deposit and retrieve patent and utility model documents. Documents relating to other IP rights, such as industrial Designs and trademarks will be exchanged through the system once the participating offices have made the necessary operational and technical changes.

The main effects of the notifications, as well as information on digital libraries which have been designated, are summarized in the table below. For more information, refer to the [complete notifications](#).

WIPO DAS

Why use this service?

Applicants

Easy

- Simply ask the office of first filing to add the priority document into the system, and request offices of second filing to use the service for obtaining access.

Secure

- Use of an access code to authorize access;
- Documents exchanged via secure channels;
- Service hosted and administered by WIPO.

Quick

- No need to provide a certified copy of a priority document separately to each office of second filing.

Inexpensive

- No need to pay for multiple copies of paper priority documents;
- No charges by WIPO. Offices can charge, but it is expected that most will not.

WIPO Lex

WIPO

Home > Reference > WIPO Lex

WIPO Lex

WIPO Lex is a one-stop **search facility** for national laws and treaties on intellectual property (IP) of WIPO, WTO and UN Members. It also features related information which elaborates, analyzes and interprets these laws and treaties. It provides streamlined access to reference material of key importance for optimal information on the global IP System.

[Members' Profiles](#)
[Treaty Secretariat](#)
[WIPO-WTO Common Portal](#)
[Glossary](#)

- [About WIPO Lex](#)
- [Disclaimer and Copyright Notice](#)
- [Contact us](#)

IP Legislation

Treaties

Full Text Search

WIPO/WTO/UN Members

United Arab Emirates (26)
United Kingdom (296)
United Republic of Tanzania (26)
United States of America (165)
Uruguay (55)
Uzbekistan (94)
Vanuatu (35)

Subject Matter

Select a Topic

Search WIPO Lex

News on IP Laws

All news

Email updates

www.wipo.int/wipolex

WIPO
WORLD
INTELLECTUAL PROPERTY
ORGANIZATION

United States of America (168 texts)

Quick Access: [Laws \(90 texts\)](#) | [Implementing Rules/Regulations \(77 texts\)](#) | [Treaty Approvals \(1 texts\)](#) | [IP Legal Literature \(14 texts\)](#) | [Treaty Membership \(114 texts\)](#) | [Relevant links](#)



Outline of the Legal and Regulatory Framework for Intellectual Property in the United States of America

Laws

Constitution / Basic Law

- [The Constitution of the United States of America \(1787\)](#)

Main IP Laws: enacted by the Legislature

- [Defend Trade Secrets Act of 2016 \(Public Law No. 114-153\) \(2016\)](#)
- [U.S. Patent Law, 35 U.S.C. §§ 1 et seq. \(consolidated as of May 2015\) \(2015\)](#)
- [U.S. Trademark Law: Rules of Practice in Trademark Cases, 37 C.F.R. 2 et seq. & Federal Statutes; Trademark Act, 15 U.S.C. §§ 1051 et seq. & Patent Act, 35 U.S.C. Part 1 \(Consolidated Trademark Law and Regulation as of July 11, 2015\) \(2015\)](#)
- [Act to Correct and Improve Certain Provisions of the Leahy-Smith America Invents Act and Title 35, United States Code \(Public Law No. 112-274, 126 Stat. 2456\) \(2013\)](#)
- [Patent Law Treaties Implementation Act of 2012 \(Public Law 112–211, 126 Stat. 1527\) \(2012\)](#)
- [Act to Amend the Trademark Act of 1946 to Correct an Error in the Provision](#)
- [Leahy-Smith America Invents Act \(AIA\) \(2011\)](#)
- [Stevenson – Wydler Technology Innovation Act of 1980, as amended through 3982\), 2011 \(2011\)](#)
- [U.S. Copyright Law, 17 U.S.C. §§ 101 et seq. \(Consolidated Copyright Laws](#)
- [Copyright Cleanup, Clarification, and Corrections Act of 2010 \(2010\)](#)
- [Trademark Technical and Conforming Amendment Act of 2010 \(Public Law](#)
- [Prioritizing Resources and Organization for Intellectual Property Act of 2008](#)
- [Vessel Hull Design Protection Amendments of 2008 \(Public Law 110-434, 1](#)
- [Copyright Royalty Judges Program Technical Corrections Act \(Public Law 1](#)
- [Plant Variety Protection Act, 7 U.S.C. §§ 2321 et seq. & Plant Variety Protect](#)

IP-related Laws: enacted by the Legislature

- [Small Business Act \(as amended through Public Law 113–76, 128 Stat. 5 on January 17, 2014\) \(2014\)](#)
- [Unlocking Consumer Choice and Wireless Competition Act \(Public Law 113-144, 128 Stat. 1751\), 2014 \(2014\)](#)
- [Communications Act of 1934, \(as amended through Public Law 112–96, enacted February 22, 2012\), Title 47 U.S.C., Section 151 et seq \(2013\)](#)
- [U.S. Crimes and Criminal Procedure, 18 U.S.C. §§ 1 et seq. \(2013\)](#)
- [Code of Federal Regulations, Title 19, Customs Duties \(Revised as of April 1, 2012\) \(2012\)](#)
- [America Competes Reauthorization Act of 2010 \(Public Law 111-358, 124 Stat. 3982\) \(2011\)](#)
- [National Defense Authorization Act for Fiscal Year 2012 \(2011\)](#)
- [United States– Panama Trade Promotion Agreement Implementation Act \(Public Law 112-43, 125 Stat. 497\) \(2011\)](#)
- [United States–Colombia Trade Promotion Agreement Implementation Act \(2011\)](#)
- [United States - Korea Free Trade Agreement Implementation Act \(2011\)](#)
- [28 U.S.C Chapter 91-United States Court of Federal Claims \(2011\)](#)
- [Section 355 of the Federal Food, Drug, and Cosmetic Act, 21 U.S.C. § 355 \(2010\)](#)
- [U.S. Code: Title 47 - Telecommunications \(Revised as of October, 2010\) \(2010\)](#)
- [Satellite Television Extension and Localism Act of 2010 \(2010\)](#)

Implementing Rules/Regulations

Intellectual Property

- [U.S. Trademark Law: Rules of Practice in Trademark Cases, 37 C.F.R. 2 et seq. & Federal Statutes; Trademark Act, 15 U.S.C. §§ 1051 et seq. & Patent Act, 35 U.S.C. Part 1 \(Consolidated Trademark Law and Regulation as of July 11, 2015\) \(2015\)](#)
- [Extension of the Extended Missing Parts Pilot Program; Notice \(2014\)](#)
- [37 CFR Part 201 - Changes to Recordation Practices, Final Rule \(2014\)](#)
- [Elimination of Patents Search Templates; Notice \(2014\)](#)
- [37 CFR Part 1- Revisions to Implement the Patent Term Adjustment Provisions of the Leahy-Smith America Invents Act Technical Corrections Act; Final Rule \(2014\)](#)

B. Tools facilitating access to, understanding and use of IP information

- Patent Landscape Reports
- Guidelines for Preparing Patent Landscape Reports
- Manual on Open Source Tools for Patent Analytics

How are decisions taken in a knowledge economy?

- Cross sectoral/disciplinary effort: many aspects taken into account (Science/Policy/Economics/Business/Marketing)
 - Policy/Regulations
 - Relevant market definition and analysis
 - Competitors activity and analysis
 - Economic/financial aspect
 - Risk
- Data-driven decisions
- Patent Information: important source of:
 - Technical
 - Business information
 - Legal

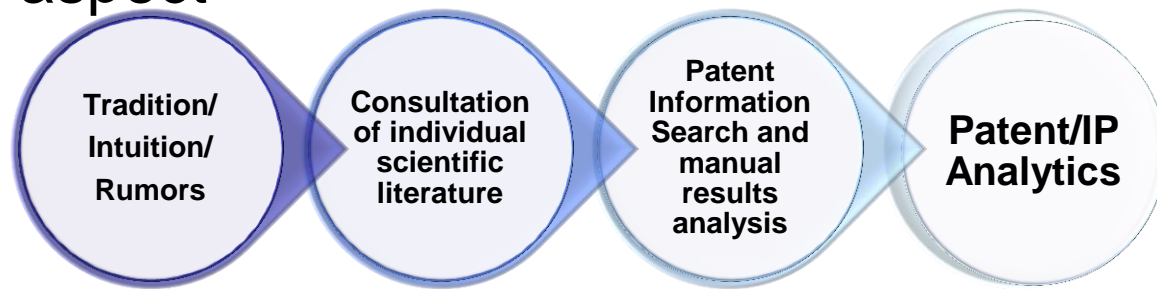

What is a Patent Landscape Report (PLR)?

- Research and analysis of **innovation patterns** and **patenting trends** in a specific **technological field/geographical area** using patent information
- Transformation of **raw patent data** through **patent search** (patent databases) into **comprehensive for non-experts patent analysis** (breakdown and analysis of the results, visualization, conclusions)



- Facilitates dialogue between various stakeholders, creating easily understood by non-experts data

What kind of questions can a PLR answer?



(The Answer to The Ultimate Question of Life, the Universe, and Everything, The Hitchhiker's Guide to the Galaxy, Douglas Adams)

- Which **technology trends** exist in which **geographical areas** and how have they developed **over time**?
- Are there gaps or **white spaces**, i.e. areas with little patent protection, that permit business opportunities or give them an added value?
- Which **players** are the **most active** in a said technical area and what is their specific focus and strategy?
- Which **other patents** are **relevant** for a **company's activities** or a **product development/commercialization**? (Infringement/FTO, licensing-in, collaborations)
- Which **patents** are **about to expire** ? Which technologies move in the **public domain** and provide **business opportunities** ?
- What is the **patent portfolio of competitors** and what is the **impact on the company's portfolio** and activities? **Correlation** and **effect on value**

WIPO Patent Landscape Reports Topics

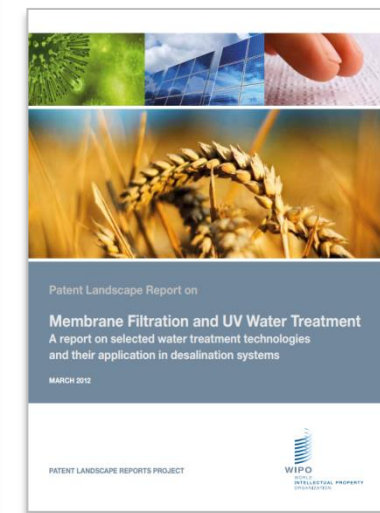
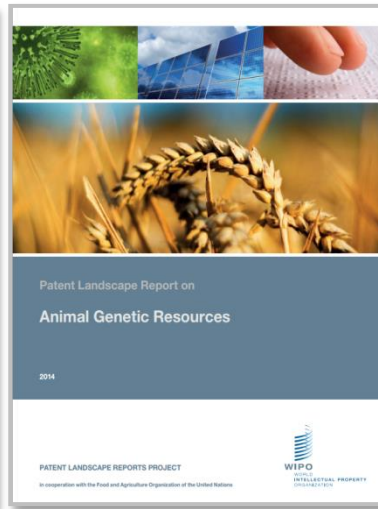
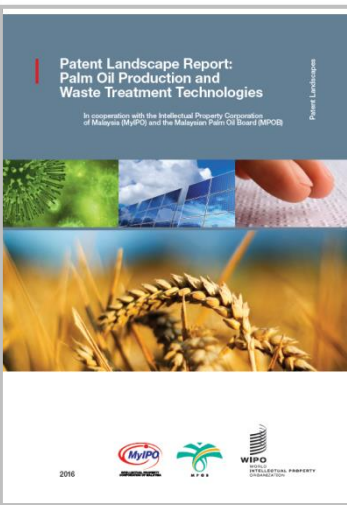

Unique compilation of PLR prepared by other organizations

WIPO
WORLD INTELLECTUAL PROPERTY ORGANIZATION

Media | Meetings | Contact Us | My Account

IP Services | Policy | Cooperation | Reference | About IP | Inside WIPO

Search WIPO

Home | Reference | PATENTSCOPE | Patent Landscapes

Patent Landscape Reports by Other Organizations

On this page: [Public health/life sciences](#) | [Climate change/energy](#) | [Food & agriculture](#) | [Other areas of technology](#) |

Larger patent landscape collections, technology bulletins & other relevant links

The following patent landscape reports - published by international organizations, national intellectual property offices, non-governmental organizations and private sector entities - are freely available or can be obtained upon request, either free of charge or for a fee.

This list, compiled by WIPO, is not exhaustive and we are continuing to extend the list with recommendations you have for other reports to be included.

Shortcuts
WIPO's patent landscape reports

Over 170 PLR
available (July 2016)

Title	Author	Date	Language
Wearable Technology PDF	LexInnova	2016	English
Worldwide Innovation Filing Trends 1995-2015	PatSeer	2015	English
The Australian Mining Industry: More than Just Shovels and Being the Lucky Country PDF	IP Australia	2015	English
Patent Landscape Study on Polyethylene Furanoate (PEF) PDF	IIPRD India	2015	English
Research Performance of University Patenting in Australia: A Pilot Assessment PDF	IP Australia	2014	English
Kestävä kaivostoilinta. Kaivosten ja louhinnan koneet – Patentti- ja innovaatiomaisema (Sustainable mining. Machines for mining and rock breaking - Patent and Innovation Landscape) PDF	VTT Technical Research Centre of Finland Ltd.	2013	Finnish
Nanofabrics Patent Search and Analysis Report PDF	Patent INSIGHT Pro	2013	English
Buckypaper PDF	LexInnova	2013	English
Termografía de impresión (Thermography printing)	Superintendency of Industry and Commerce, Colombia	2013	Spanish
Papel electrónico (Electronic paper)	Superintendency of Industry and Commerce, Colombia	2013	Spanish

Guidelines for Preparing Patent Landscape Reports

- Published in September 2015 and available on http://www.wipo.int/patentscope/en/programs/patent_landscapes
- Structure:
 - Background information on patent information
 - Objectives and motivations for preparing PLRs
 - Different types of patent analysis
 - Tasks associated with the preparation of PLRs
 - Stages in the preparation of PLRs
 - Examples and experience from WIPO's work in

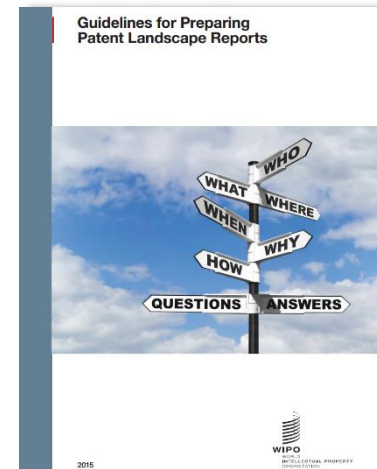

The Manual on Open Source Tools for Patent Analytics

- Project launched in May 2015, funded by FIT-JP
- Aimed at exploring:
 - various free and open source tools which could be used for various patent analysis tasks by users in developing countries
 - Includes walkthrough for using selected software for various analytics tasks

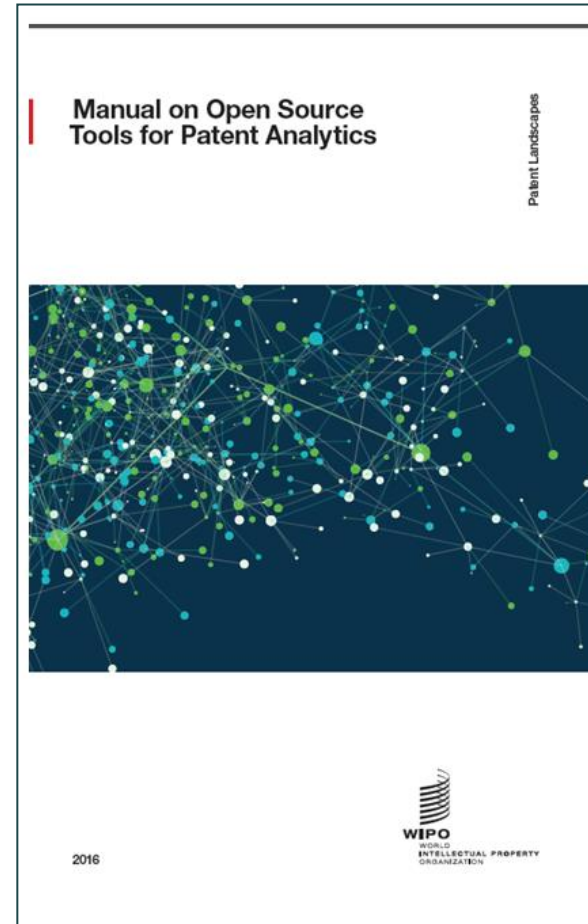

Which analytics tasks, databases and tools does the Manual cover?

■ Obtaining Data

rplos

ROpenSci
This package is part of the rOpenSci project.
To learn more, visit [rOpenSci.org](https://ropensci.org)

PATENTSCOPE

Espacenet

IO Lens



■ Cleaning Data



■ Visualizing Data

Gp Gephi

+tableau++public

■ Sharing Data

GitHub



infogr.am

What can the users produce when using these tools?

História 1 Overview publication countries search titles search phrases

The rise of the drones

There has been a dramatic rise in patent activity for drones.
The data is dominated by aircraft and computing including weapons.
The top applicants and Thales and Elwha.
The US is the top country for publications with China emerging.
Search the data and click on a title.
Click to lookup activity for Drones using key terms from titles.

trends

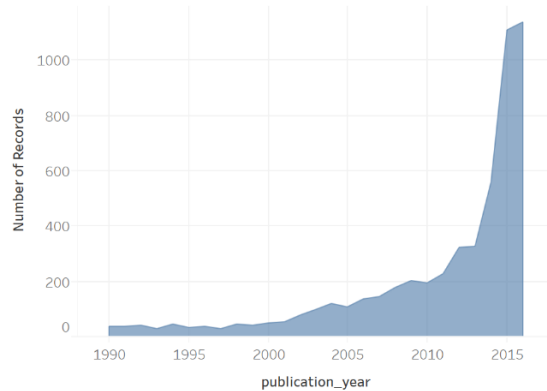

technology areas

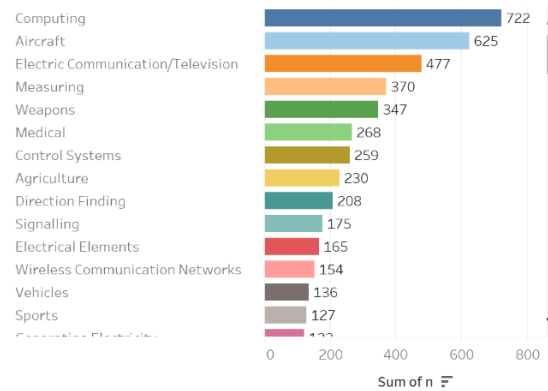

organisations

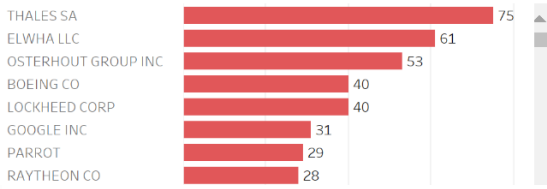

inventors

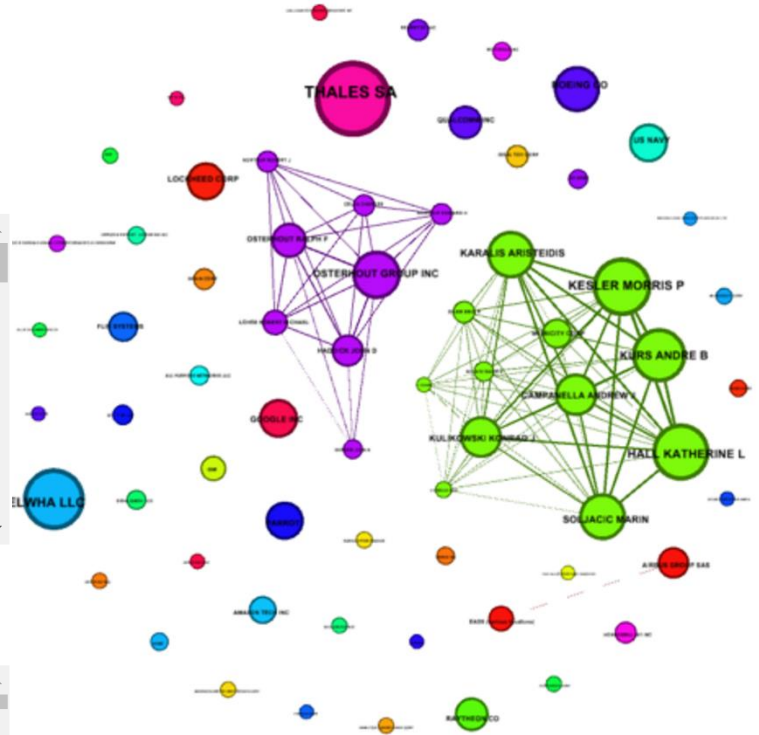

Gephi

C. Multi-stakeholder Platforms

WIPO GREEN

The screenshot shows the homepage of WIPO GREEN. The header features the WIPO GREEN logo and navigation links for Contact Us, My Account, and WIPO. Below the header is a green navigation bar with links for Home, Database, Network, About Us, and Join Us, along with a search bar. The main content area is titled "WIPO GREEN – The Marketplace for Sustainable Technology" and includes a sub-header "On this page: Database | Network | Join us | The challenge | Related links". The text describes WIPO GREEN as an interactive marketplace for green technologies. A section titled "Find an expert" features an image of two colorful pinwheels and text explaining the upcoming WIPO GREEN Experts Database. At the bottom, there are three columns: "Database" (search for green technology products), "Network" (facilitate commercial relationships), and "Join us" (become a partner or user).

WIPO Re:Search

The screenshot shows the homepage of WIPO Re:Search. The header features the WIPO Re:Search logo and navigation links for Contact Us and WIPO. Below the header is a green navigation bar with links for Home, Database, Collaborations, Supporting Services, and About Us, along with a search bar. The main content area is titled "WIPO Re:Search" and includes a sub-header "On this page: Activities | The challenge | Related links". The text describes WIPO Re:Search as a platform for medical products for neglected tropical diseases. A section titled "Why WIPO Re:Search?" and "What are the benefits of WIPO Re:Search?" are visible. On the right side, there is an image of a laboratory with a caption: "Learn about how WIPO Re:Search is contributing to the fight against neglected tropical diseases."

WIPO Match



WIPO Green

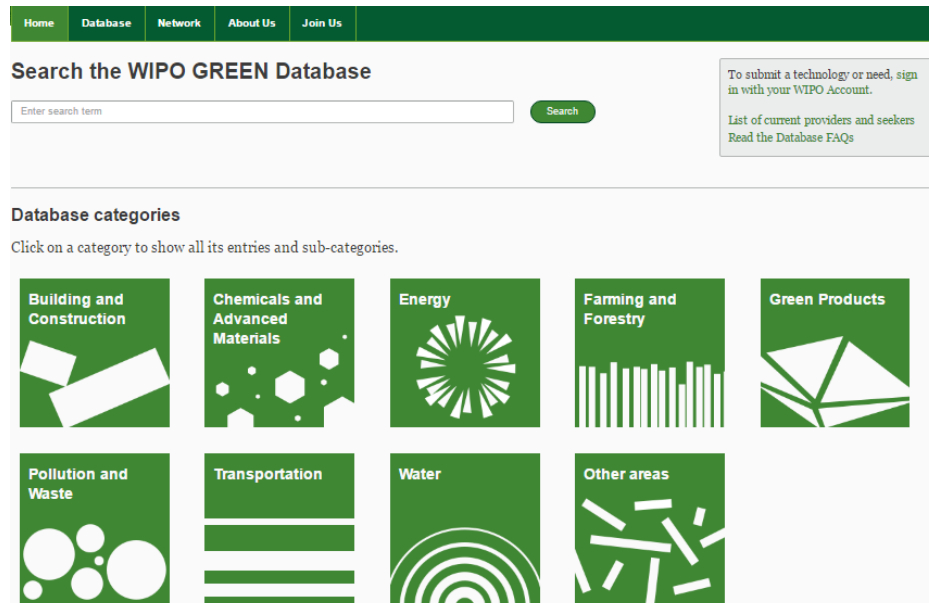

<https://www3.wipo.int/wipogreen>

- The marketplace for sustainable technology: search functionality for technology providers and seekers
- Network of green technologies stakeholders
- Grouped in 9 technology areas

WIPO Green example: Energy



Search the WIPO GREEN Database

To submit a technology or need, [sign in with your WIPO Account](#).

[List of current providers and seekers](#)
[Read the Database FAQs](#)

Results per page: ▾

All Results

[Technologies \(1220\)](#)
[Needs \(30\)](#)

All Categories

[Energy \(1250\)](#)
 [Solar \(327\)](#)
 [Biomass/Bioenergy \(217\)](#)
 [Energy efficiency \(152\)](#)
 [Energy storage \(149\)](#)
 [Energy generation \(Others\) \(134\)](#)
 [Fuel cells \(98\)](#)
 [Other \(53\)](#)
 [Wind \(48\)](#)
 [Waste to energy \(35\)](#)
 [ICT in energy \(31\)](#)
 [Energy distribution \(24\)](#)

Showing 1-10 of 1250 results > Database Search > Energy

[1- 10](#) [11- 20](#) [21- 30](#) [31- 40](#) [41- 50](#) [51- 60](#) [61- 70](#) [71- 80](#) [81- 90](#) [91- 100](#) ... [1241-1250](#) »

Powerful New Enzyme for Transforming Biomass

Background:

Converting plant cellulose and hemicellulose into fermentable sugars is a major bottleneck in the biofuel industry. Chemical pretreatment and enzyme hydrolysis (breakdown) usually are required.

Among chemical pretreatments, ammonia fiber expansion (AFEX) alkaline pretreatment has many advantages.

Last updated: December 21, 2015

Submitted by: Wisconsin Alumni Research Foundation (WARF)

Simplified Daylight Harvesting

WIPO Re:Search

- Initiative aiming at promoting the development of medicines for neglected diseases, malaria and TB
- Includes a database with information on availability of IP rights and other information
- Voluntary contribution

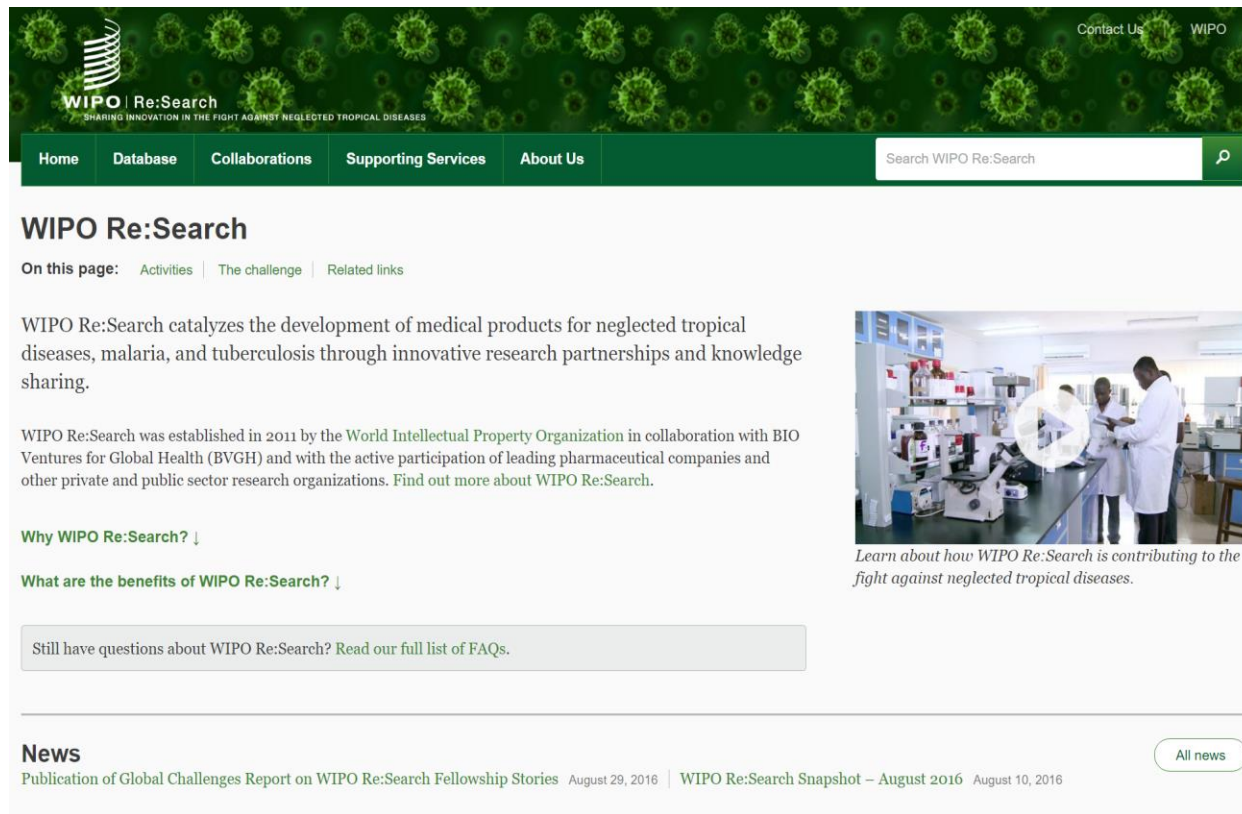

The screenshot shows the homepage of the WIPO Re:Search website. The header features the WIPO Re:Search logo with the tagline "SHARING INNOVATION IN THE FIGHT AGAINST NEGLECTED TROPICAL DISEASES" and a navigation menu with links for Home, Database, Collaborations, Supporting Services, and About Us. A search bar is located in the top right corner. The main content area includes a section titled "WIPO Re:Search" with sub-links for "On this page: Activities | The challenge | Related links". Below this is a paragraph describing the organization's mission: "WIPO Re:Search catalyzes the development of medical products for neglected tropical diseases, malaria, and tuberculosis through innovative research partnerships and knowledge sharing." A second paragraph states: "WIPO Re:Search was established in 2011 by the World Intellectual Property Organization in collaboration with BIO Ventures for Global Health (BVGH) and with the active participation of leading pharmaceutical companies and other private and public sector research organizations. Find out more about WIPO Re:Search." There are two expandable sections: "Why WIPO Re:Search? ↓" and "What are the benefits of WIPO Re:Search? ↓". A grey box contains the text: "Still have questions about WIPO Re:Search? Read our full list of FAQs." On the right side, there is a photograph of a laboratory with a white play button overlay. Below the photo is the caption: "Learn about how WIPO Re:Search is contributing to the fight against neglected tropical diseases." At the bottom, there is a "News" section with a link to "Publication of Global Challenges Report on WIPO Re:Search Fellowship Stories August 29, 2016" and "WIPO Re:Search Snapshot – August 2016 August 10, 2016". An "All news" button is also present.

<http://www.wipo.int/research>

What can you search for?

Structured Search | Full Text Search

Provider:

- Aberystwyth University
- African Institute of Biomedical Sciences and Technology (AIBST)
- Alnylam
- Caltech
- Center for Infectious Disease Research
- Center for World Health and Medicine (CWHM)
- Centre of Excellence for Malaria Diagnosis, University of Lagos
- Drugs for Neglected Diseases initiative (DNDi)
- Eisai
- Eskitis Institute
- GlaxoSmithKline (GSK)
- Infectious Disease Research Institute (IDRI)
- International Centre for Genetic Engineering and Biotechnology (ICGEB)
- International Vaccine Institute (IVI)
- Kumasi Centre for Research in Tropical Medicine (KCRTM)
- Liverpool School of Tropical Medicine (LSTM)
- Massachusetts Institute of Technology (MIT)
- McGill University (McGill)
- Medical Research Council of South Africa (MRC)
- Medicines for Malaria Venture (MMV)
- Merck (MSD)
- National Institute of Parasitic Diseases, China
- National University of Singapore
- NIH (USA)
- Northeastern University (NEU)
- Novartis
- PATH
- Pfizer
- Sanofi
- Stanford University
- Swiss Tropical and Public Health Institute
- Theodor Bilharz Research Institute - (TBRI)
- Trypanosomiasis Research Centre at the Kenya Agriculture Research Institute (KARI)
- University of Bamako, Mali
- University of British Columbia
- University of Buea, Cameroon
- University of California Berkeley
- University of Dundee, UK
- University of Edinburgh, UK
- University of South Florida
- University of Ibadan, Nigeria
- University of Kansas (KU)
- University of Washington, Seattle
- Walter Reed Army Institute of Research (WRAIR)

Disease:

- Unknown or Others
- Buruli Ulcer
- Chagas disease (American trypanosomiasis)
- Cysticercosis
- Dengue/dengue hemorrhagic fever
- Dracunculiasis (guinea-worm disease)
- Echinococcosis
- Endemic treponematoses (Yaws)
- Foodborne trematode infections (Clonorchiasis, Fascioliasis, Human African trypanosomiasis)

Type of data:

- Screening, Hits Data
- Hit-to-Lead
- Lead Series
- Pre-Clinical Candidate
- Clinical Candidate
- Marketed Product
- Enabling Technology (platform)
- Intellectual Property (patents)
- Formulation
- Diagnostic Tool
- Vaccine Technology
- New Biological Entity
- Other Data, Know-how, Services, Resources

WIPO Match

WIPO Match Leveraging IP for Development

A free online tool that brings people and organizations together to harness the power of intellectual property for economic and social development



www.wipo.int/dmd

- On-line market place to match specific IP Technical Assistance needs with resources offered by potential providers/donors.

WIPO Match

Who can join?

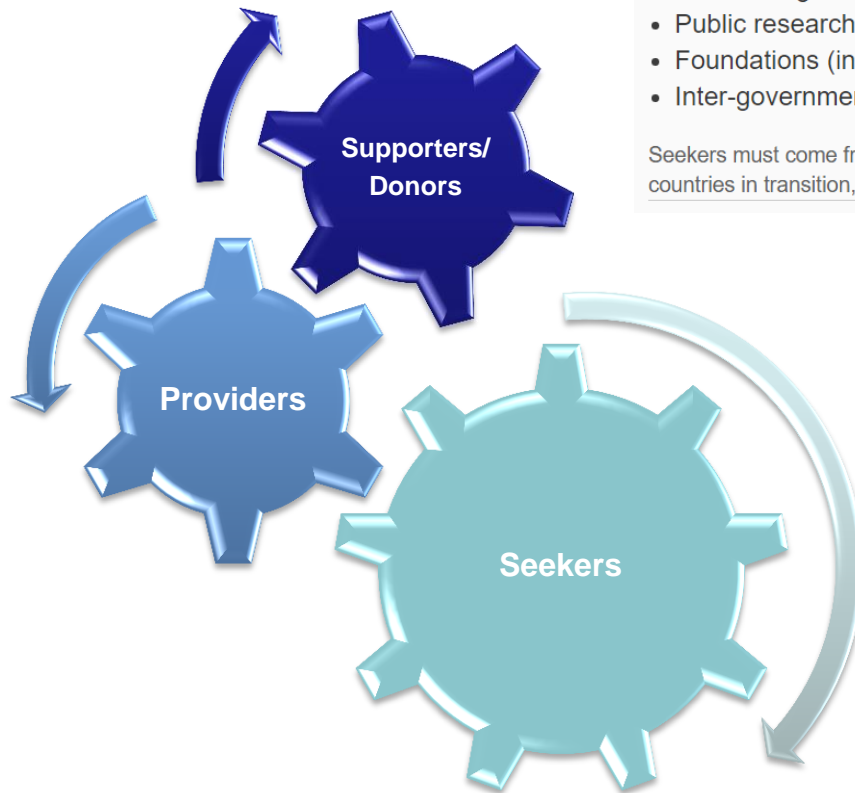

Seekers

- IP offices
- IP-related government bodies
- Public research institutions, universities
- Foundations (inc. research foundations)
- Inter-governmental organizations

Seekers must come from developing countries, countries in transition, or least developed countries.

Providers

- Governments
- Non-governmental organizations, Inter-governmental organizations
- Foundations (inc. research foundations)
- Companies
- Universities

WIPO Match

Search existing Offers or Needs

Search Criteria

Interested in searching: Offers (by Donor) Needs (by Member states) All

Title:

(Use % for wild card search)

Institution/Organization Name:

(Use % for wild card search)

Search tags

Interest Area:

Funds in Trust
IP Office Automation & Modernization
IP Training & improving technical expertise
Legislative Advice

Interested in which field of IP:

Select

Interested Regions:

Select region(s)
African Countries (Including Arab)
African Portuguese Speaking Countries (LUSOPHON)
Arab (Some African, Some Asian) Member Of LAS

Interested Country Groups:

Select country group (s)
Developing Countries
Least Developed Countries LDC's

Success stories?

WIPO Match Success Stories



African Regional Intellectual Property Organization (ARIPO) had posted in WIPO Match the requirement to develop a web based Database for Copyright . The above requirement was matched by International Federation of Reproduction Rights Organization (IFFRO) from Belgium who has shown interest to study and provide a Database for Copyright .



In the context of CDIP Project on IP and Tourism WIPO Match was able to Partner The Ecuadorian Government & Regional Latin American Development Bank (CAF)

Thank you!

Irene.Kitsara@wipo.int