



WIPO | HAGUE

The International
Design System

The Hague System for the International Registration of Industrial Designs

Päivi Lähdesmäki
Senior Advisor
The Hague Registry
Brands and Designs Sector
World Intellectual Property Organization

Athens

April 9, 2019



Class 21: Toy

CHRISTOS FRAGKOS, Athens
INTERNATIONAL REGISTRATION NO. 096375



Class 4: Dental
brush for dental
technician

1



AKOVOS CHATZIDIMITRIOU, Athens
INTERNATIONAL REGISTRATION NO. 095 013

Class 21:3D-sliding spherical puzzle-toy

1.1



1.2



1.3



1.4



1.5



1.6



KAINOTOMIES VERDE KYVIKA LOGIKA PAIGNIDIA A.E.B.E.(VERDES INNOVATIONS SA),
Korinthos,
ILIAS CHRONOPOULOS, Kifissia Attiki
ANASTASIA CHRONOPOULOU, Kifissia Attiki
KALLIOPI CHRONOPOULOU, Kifissia Attiki (GR)

INTERNATIONAL REGISTRATION NO. 093 553

Why Protect Industrial Designs?

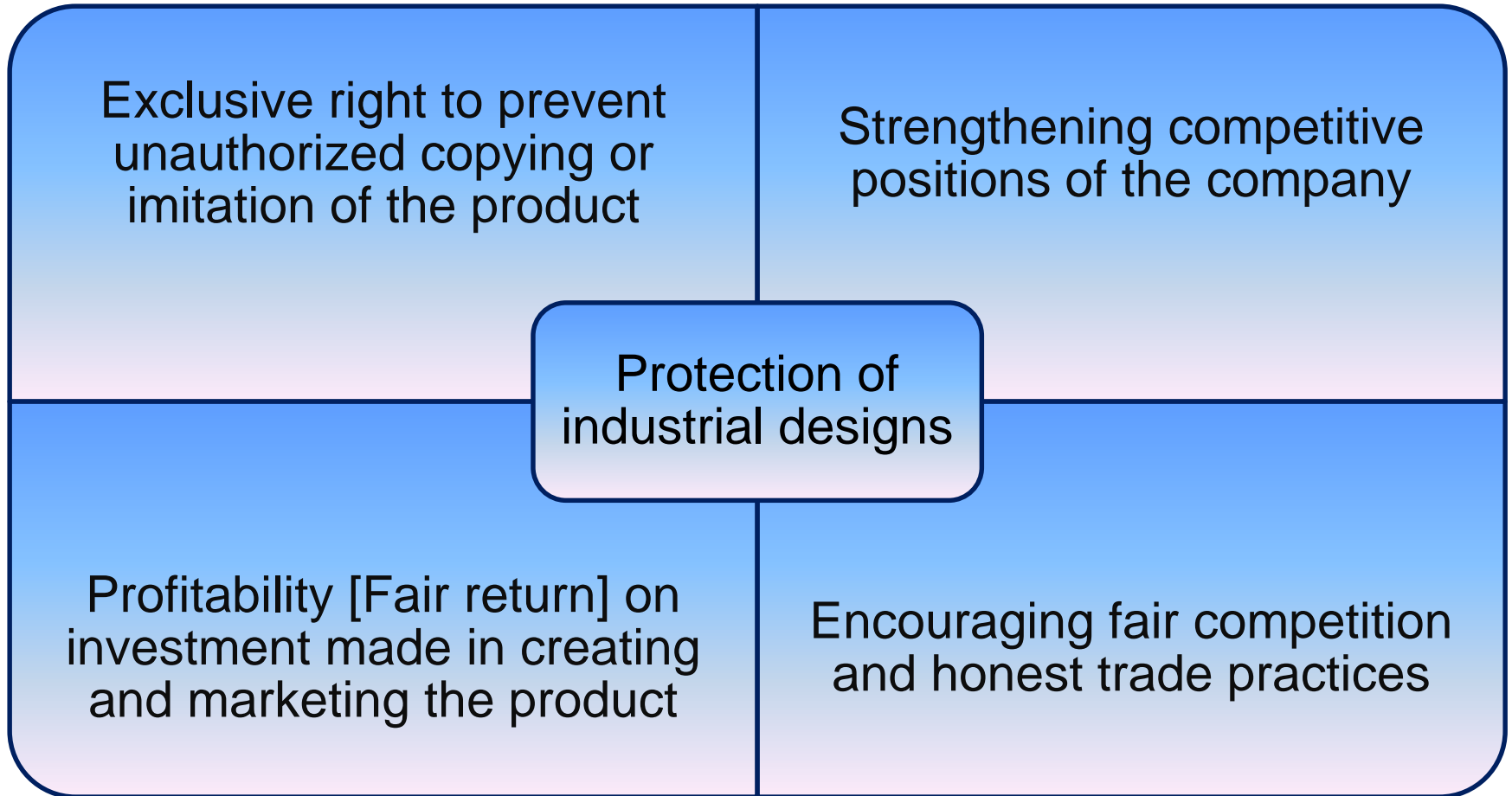

I. PALEOHORINOS FOTISTIKA A.B.E.E., GEFIRA ANCHIALOS-THESSALONIKI (GR)

INTERNATIONAL REGISTRATION NO. 101 619
Class 24 “Luminous decorations”

26

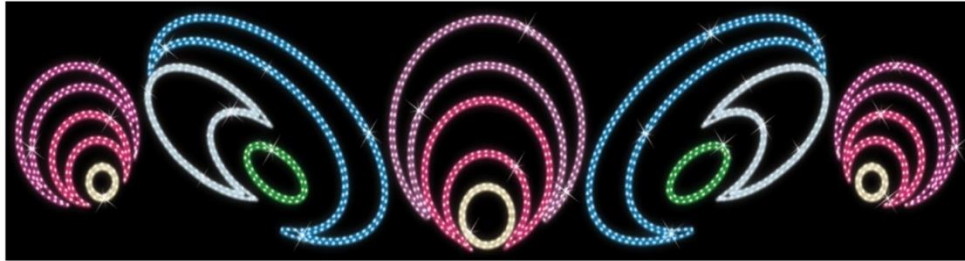

Description: 2D and 3D illuminated decorations made of aluminium, plexiglas, pvc net, pvc carpet, artificial branches, strip light, rope light, light strings and with or without powder coated frames; the designs are used for indoor or outdoor decoration.





Basic Features and Advantages of the Hague System

Independent filings vs. Hague Route

Direct/Paris Route

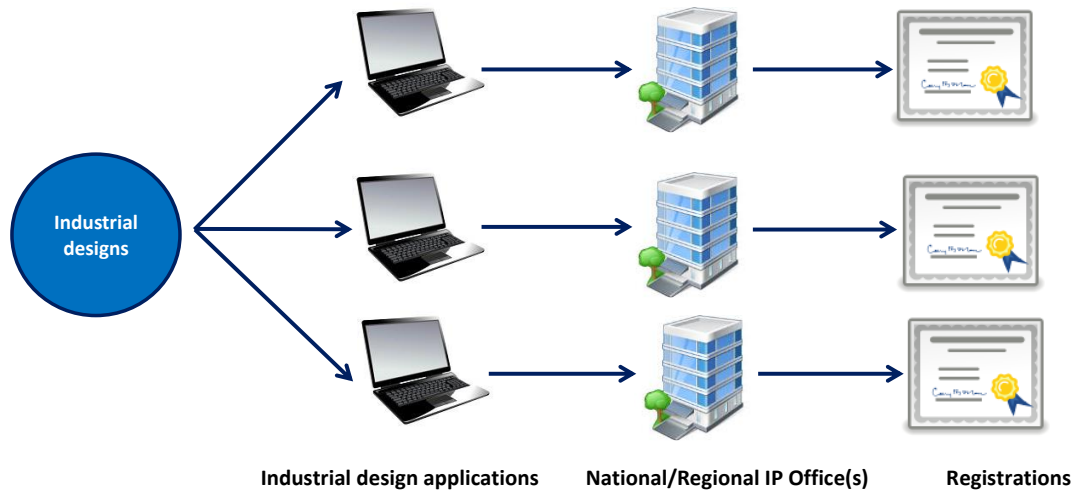

The Hague System



Who Can Use the System?

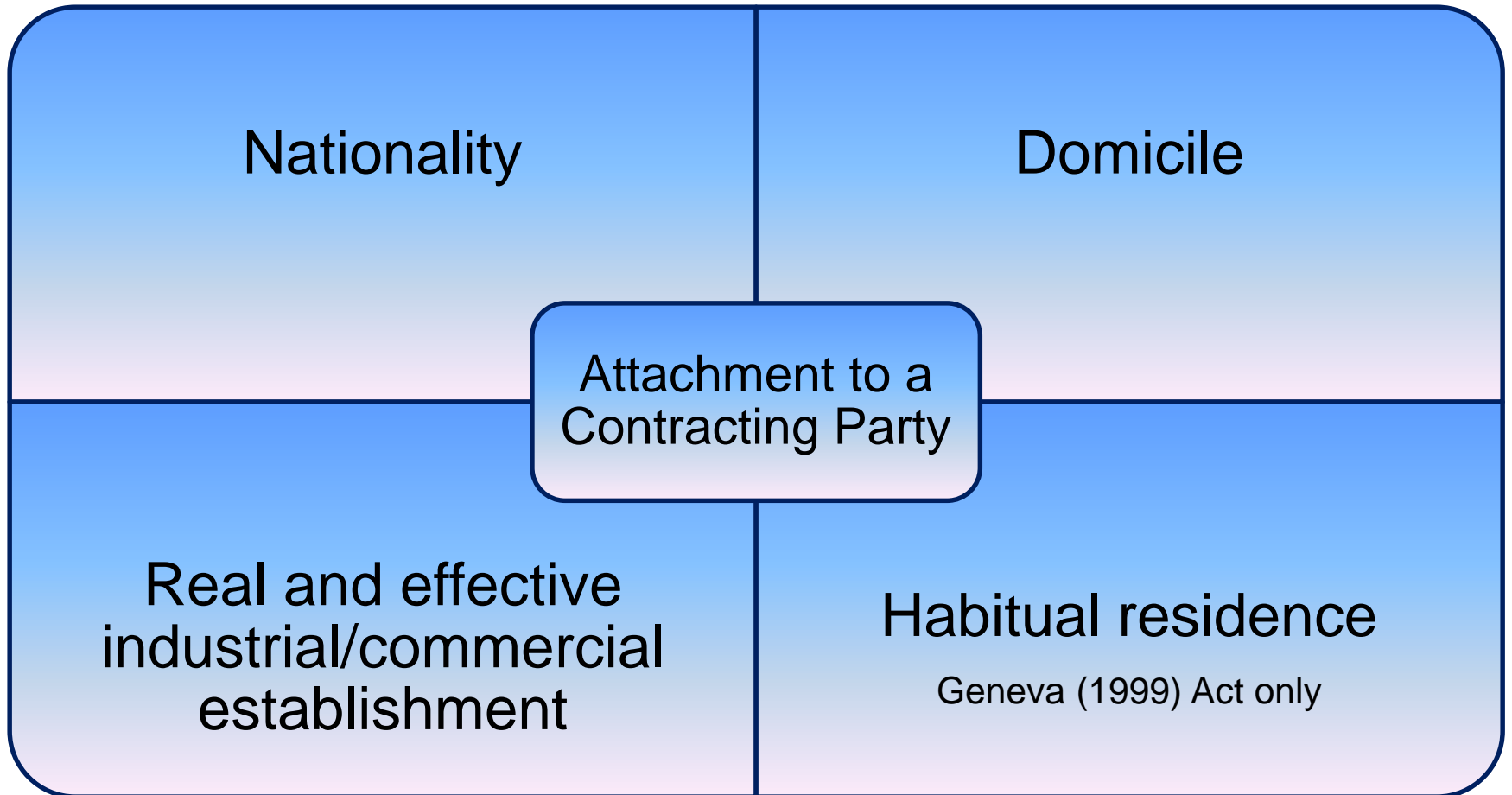

Main Features of the Hague System



Simplicity

The Hague System enables holders to obtain protection for their designs with a minimum of formality



Cost-effectiveness

Payment of a single set of fees in one currency



Efficiency

Considerable facilitation of the subsequent management of the registration



Flexibility

Right holders have more opportunities in targeting national, regional or global markets

What is the Hague System?

One to many relationships

- File a single international application for a single international registration in which one or more Contracting Parties are designated

“Bundle of rights”

- If no refusal, the resulting international registration has the effect of a grant of protection in each designated Contracting Party

The Hague System is a Procedural Arrangement

Issues such as:



the conditions for protection



the refusal procedure to be applied when deciding whether a design may be protected



the rights which result from protection

are governed by the law of each Contracting Party designated in an international registration

The International Application

In English, French or Spanish

May be filed directly with the International Bureau through the E-filing interface but also on paper

May comprise several different designs up to a maximum of 100 if they belong to the same class of the International Classification (Locarno)

One set of fees (in CHF) is to be paid

The Hague System Procedure: Role of the International Bureau

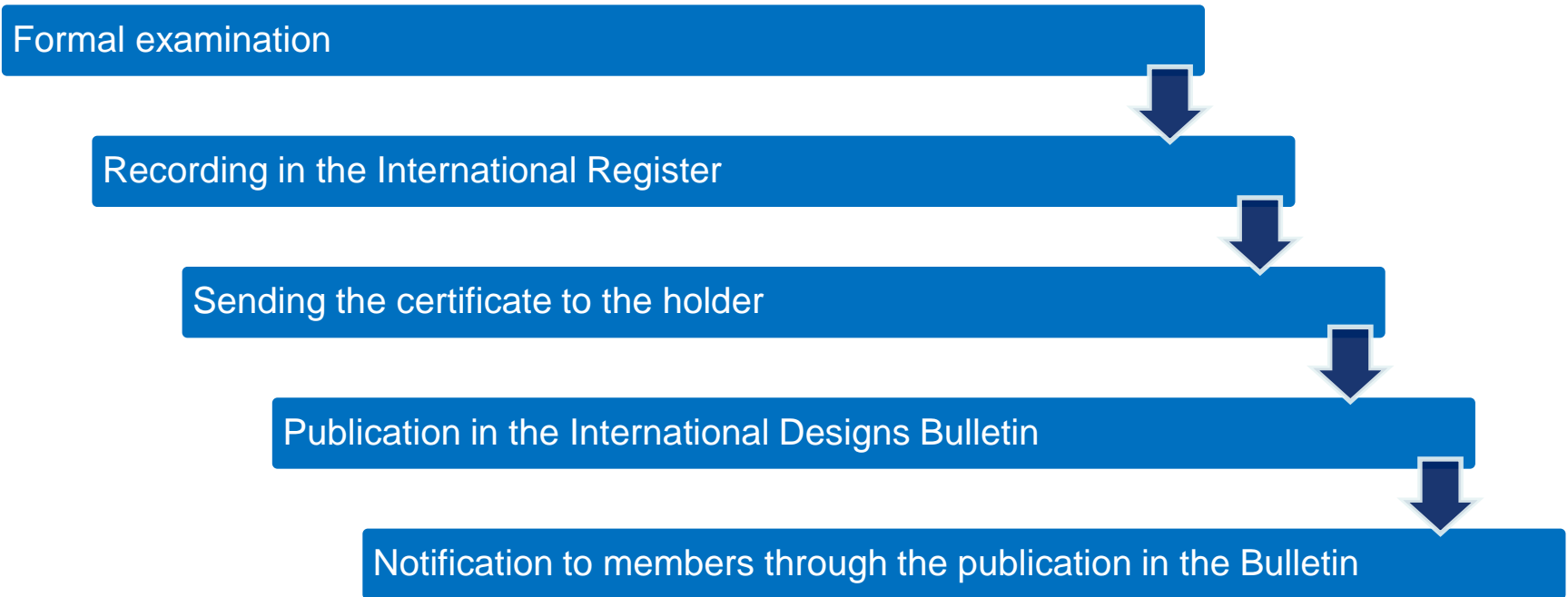

If the International Bureau finds that the international application does not fulfill the applicable requirements, it invites the applicant to make the required corrections within three months from the date of invitation sent by the International Bureau.

International registration has the same effect as a regularly-filed application in all designated Contracting Parties.

The Hague System Procedure (II)

Refusal by a designated Contracting Party

on same substantive grounds as for national/regional filings

must be communicated within time limit

effect limited to territory of the member that has refused

International registration (where not refused)

no refusal = same rights as a local design registration



a bundle of independent national/regional rights

advantages of central management



The Hague System Procedure (III)

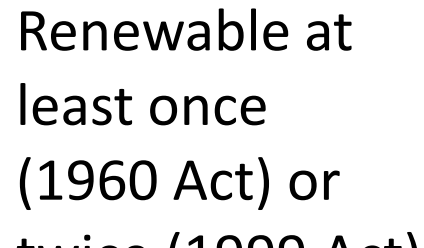

Duration of protection:
five years

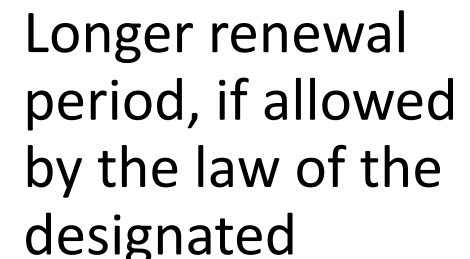

Renewable at least once (1960 Act) or twice (1999 Act)



Longer renewal period, if allowed by the law of the designated Contracting Party

General Advantages of the Hague System



Hague System (international route)

one Office for filing
one language
one currency
one international registration
one renewal
one modification
foreign attorney or agent
(first needed if refused)

National/regional route

many Offices for filing
many languages
many currencies
many registrations
many renewals
many modifications
foreign attorney or agent
(first needed at filing)



Legal Framework

Hague Agreement

```
graph TD; A[Hague Agreement] --- B[Hague Act (1960)]; A --- C[Geneva Act (1999)];
```

Hague Act (1960)

Geneva Act (1999)

- **Common Regulations, last revised: January 1, 2019**
- **Administrative Instructions, last revised: January 1, 2019**
- **National Laws and Regulations**



Going Global – Geographical Scope of the Hague System

Hague Union

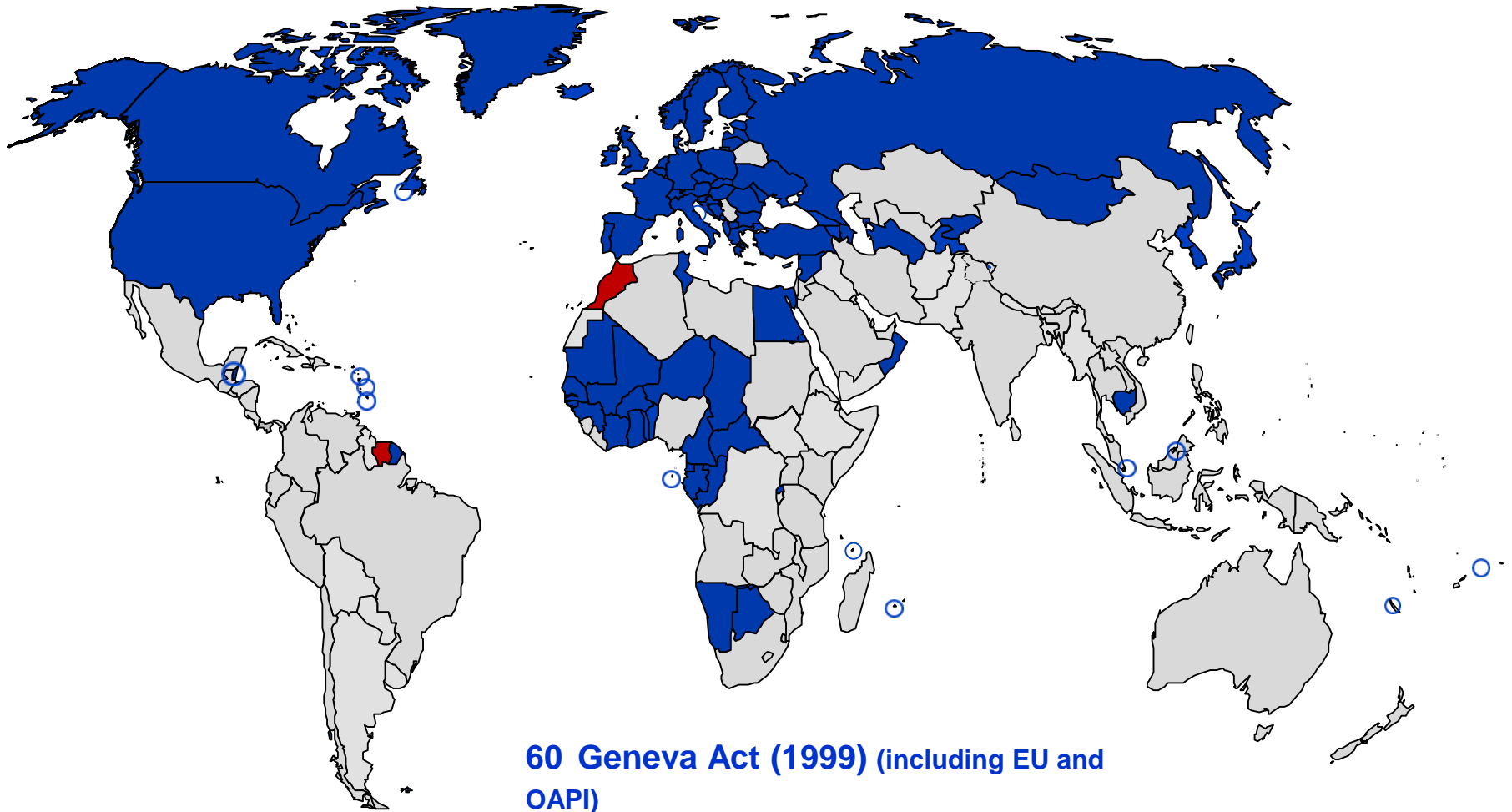

60 Geneva Act (1999) (including EU and OAPI)

10 Hague Act (1960)

70 Contracting Parties

Hague Union Members According to the Most Recent Applicable Act

Geneva Act (1999)
60 members

•African Intellectual Property Organization, Albania, Armenia, Azerbaijan, Belgium, Belize, Bosnia and Herzegovina, Botswana, Brunei Darussalam, Bulgaria, Cambodia, Canada, Croatia, D.P.R. of Korea, Denmark, Egypt, Estonia, European Union, Finland, France, Georgia, Germany, Ghana, Hungary, Iceland, Japan, Kyrgyzstan, Latvia, Liechtenstein, Lithuania, Luxembourg, Monaco, Mongolia, Montenegro, Namibia, Netherlands, North Macedonia, Norway, Oman, Poland, Republic of Korea, Republic of Moldova, Romania, Russian Federation, Rwanda, San Marino, Sao Tome and Principe, Serbia, Singapore, Slovenia, Spain, Syrian Arab Republic, Switzerland, Tajikistan, Tunisia, Turkey, Turkmenistan, Ukraine, United Kingdom and the United States of America (60)

Hague Act (1960)
10 members

•Benin, Côte d'Ivoire, Gabon, Greece, Italy, Mali, Morocco, Niger, Senegal and Suriname (10)

Geneva Act (1999)

Recent Accessions

	Belize (November 9, 2018)
	San Marino (October 26, 2018)
	Benelux Union (December 18, 2018)
	Canada (July 16, 2018)
	United Kingdom (March 13, 2018)
	Russian Federation (November 30, 2017)
	The Kingdom of Cambodia (November 25, 2016)
	D.P.R. of Korea (June 13, 2016)

Potential Accessions in 2019

	China
	Morocco
	Israel
	Mexico
	Madagascar
	Jordan
	Vietnam
	Indonesia
	Samoa
	Suriname
	Eurasian Patent Organization

Hague Union

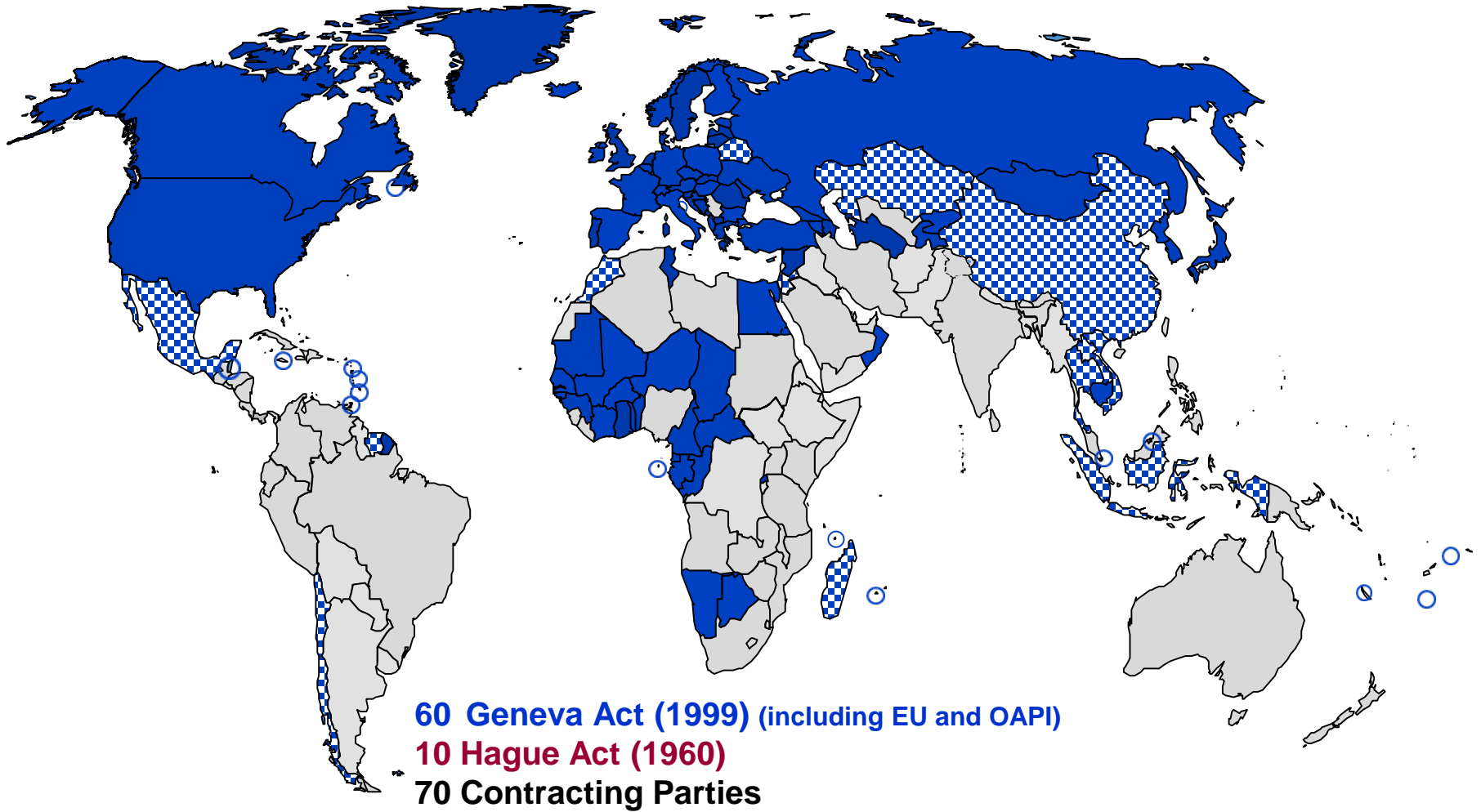

60 Geneva Act (1999) (including EU and OAPI)
10 Hague Act (1960)
70 Contracting Parties



Potential Contracting Parties of Geneva (1999) Act



Some Statistics

International Applications - 2018



5,404 international applications were received containing 19,296 designs (max. 100 designs / application)



3.7 % increase compared to the respective period in 2017 in the number of applications



-0.7% decline compared to the respective period in 2017 in the number of designs

Designations under the Hague System, in 2018

- The EU is the most designated Hague Member
 - (2018: 3,265 international registrations designated EU, containing 13,268 designs).
- The designation of the EU in an international registration covers all its Member States, including Greece.
- By comparison, Greece was only designated 45 times in 2018, since it can only be designated under the 1960 Act.

Who filed most in 2018?

- Germany: 3,964 designs
- Switzerland: 2,510 designs
- Republic of Korea: 1,547 designs
- France: 1,454 designs
- Netherlands: 1,382 designs (+71.3%)
- Italy: 1,261 designs
- United States of America: 1,293
- Japan: 1,268 (+52.6%)
- Turkey: 478
- Greece: 410

Top applicants in 2017 (design count)

(2018 complete statistics not yet available: Paleohorinos Fotistika A.B.E.E in top ten)

■ Samsung Electronics	762
■ LG Electronics	668
■ Fonkel Meubelmarketing	490
■ Procter and Gamble	488
■ Volkswagen	369
■ I. Paleohorinos Fotistika A.B.E.E.	357
■ Drylock Technologies	315
■ Kronoplus Limited	294
■ Swatch	285
■ Wenko-Wenselaar	250

International Applications Originating from Greece in 2018

- International applications :
 - **10** (in 2017: 9), which contained **410 designs** (in 2017: 371)

- I. PALEOHORINOS FOTISTIKA A.B.E.E., GEFIRA ANCHIALOS-THESSALONIKI:
 - **5** international applications, which contained **322** designs

I. PALEOHORINOS FOTISTIKA A.B.E.E. GEFIRA ANCHIALOS-THESSALONIKI (GR)

INTERNATIONAL REGISTRATION NO. 103775
Class 24 “Luminous decorations”

14





Latest Developments

Latest Developments



Guidance on reproductions (last updated November 2018)



Improvement of the E-filing interface



New Hague Information tools



Developments in the legal framework

Guidance on Reproductions

Disclosure criteria may differ depending on jurisdiction. This new Guidance is a useful tool to help applicants forestall possible refusals on the ground of insufficient disclosure of an industrial design by Examining Offices.

Prepared in consultation with Examining Offices under the Hague System and several user organizations

Detailed guidance on how to prepare and provide reproductions to overcome the most common refusal issues

- Not enough views
- Unclear representations of the claimed design
- Unclear relief or contours of surfaces of a three-dimensional product
- Difference in form/color between the representations of the claimed design

Information on which guidance should be taken into account when designating specific Contracting Parties

Not self-sufficient or all inclusive

Industrial Designs



DM/099943

SOCIÉTÉ NOUVELLE ROSSIGNOL

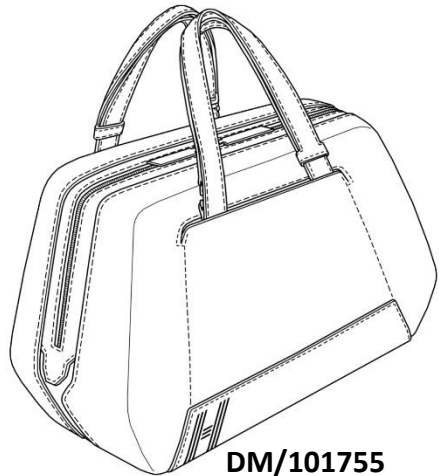

DM/101755
HERMES SELLIER



DM/100835

HERIS SERAMIK VE TURIZM SANAYI A.S.



DM/101844

LENTO OBJEKT
GMBH

1.1



DM/101165

SAMSUNG ELECTRONICS CO.,LTD.

WIPO | HAGUE
The International
Design System

Reproduction Examples That Have Passed the Disclosure Test Before All Concerned Offices (1)

1.1



1.1) Perspective

1.2



1.2) Perspective

D089713 – Hilti Aktiengesellschaft

1.3

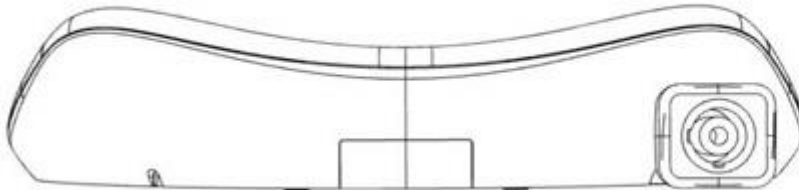

1.3) Back

1.4

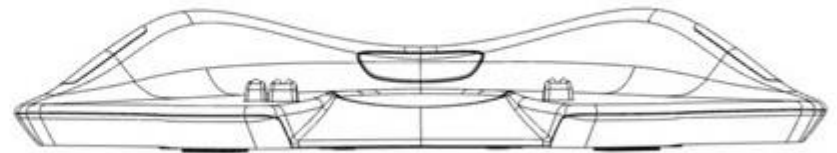

1.4) Front

D087535 – Softbank Robotics

Reproduction Examples That Have Passed the Disclosure Test Before All Concerned Offices (2)

1.2



1.2) Back

1.3



1.3) Left

1.4



1.4) Right

D089858 – Ninebot (Beijing) Tech

1.1

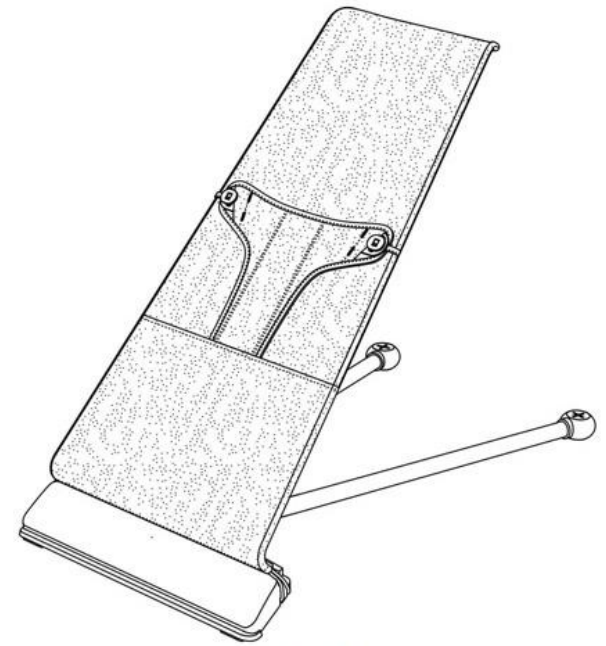

1.1) Perspective

D086974 – Babybjörn AB

Improvement of the E-Filing Interface



Receive and download notifications from the IB relating to international applications



Send corrections to irregularities or defects

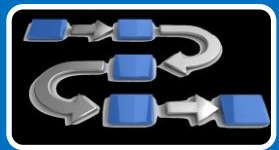

Retrieve in real-time current status of international application



New payment options in the E-filing interface



Indication of access code obtained from the IP office of first filing, so that the IP office of the designated Contracting Party is able to access the priority document via the WIPO Digital Access Service (DAS)

EHague

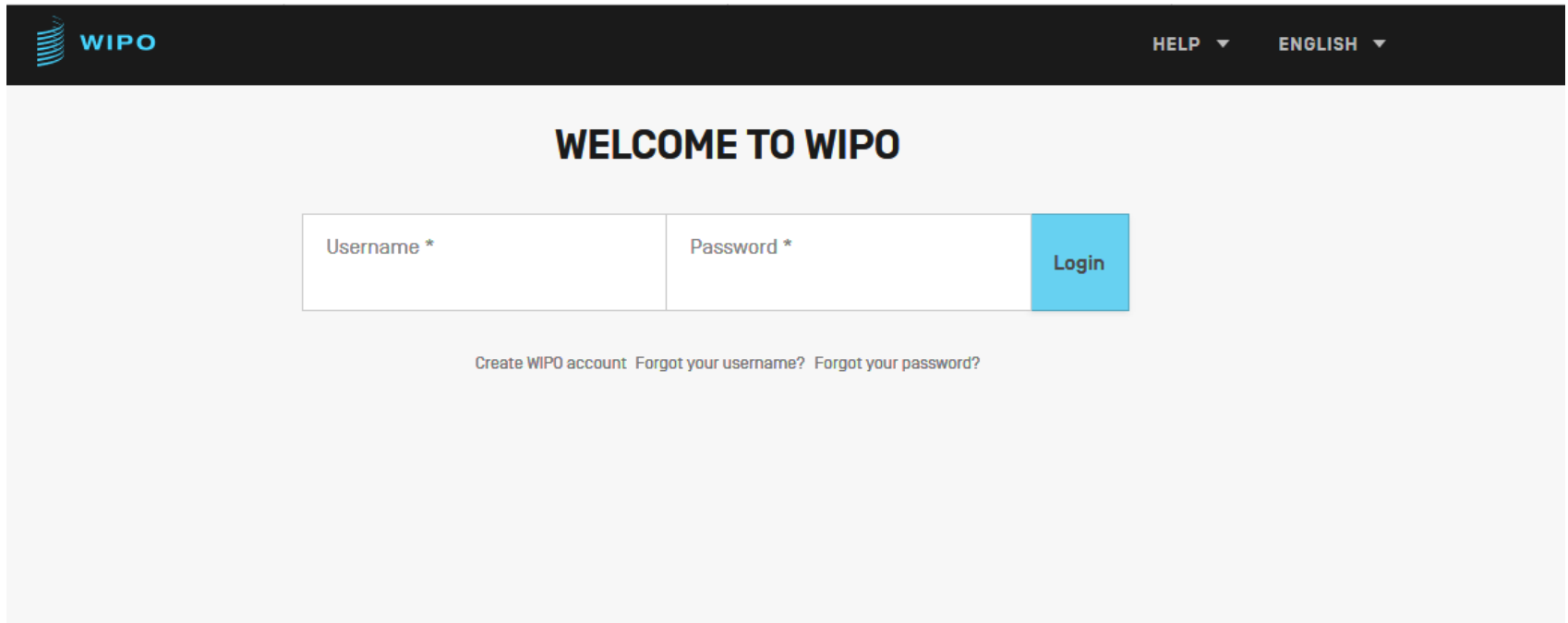

The screenshot shows the top navigation bar with the WIPO logo on the left and 'HELP' and 'ENGLISH' dropdown menus on the right. The main heading is 'WELCOME TO WIPO'. Below this is a login form with two input fields: 'Username *' and 'Password *'. To the right of these fields is a blue 'Login' button. Below the form are three links: 'Create WIPO account', 'Forgot your username?', and 'Forgot your password?'.

- Login at: <https://www3.wipo.int/HagueEFilingWeb/>
- WIPO account required

Workbench

E-HAGUE

1 New	2 Filed application[s] [21]	3 Draft[s] [12]	4 E-filing communication [3 unread]	5 E-filing tutorial
----------	--------------------------------	--------------------	--	------------------------

- New application
- New application using data from a filed application
- New application from a draft

Warning

It is a requirement under the law of the United States of America that, for designs created in the United States of America, the applicant first obtains a license from the United States Patent and Trademark Office [USPTO] before filing outside of the United States of America.

It is a requirement under the law of the Russian Federation that designs created in the Russian Federation by Russian legal entities or nationals are subject to a security clearance procedure by the Federal Service for Intellectual Property [ROSPATENT] to ensure that the designs do not contain state secrets.

Confirm

- 1 – Create a new application
- 2 – List of applications filed with the IB
- 3 – Draft applications not yet filed with the IB
- 4 – Communications from the IB
- 5 – An online tutorial

Workbench

WIPO | HAGUE E-HAGUE 6 SUPPORT 7 ENGLISH 8 JONAH 9 LOGOUT 10

E-HAGUE

New Filed application[s] (21) Draft[s] (12) E-filing communication [3 unread] E-filing tutorial

- New application
- New application using data from a filed application
- New application from a draft

Warning

It is a requirement under the law of the United States of America that, for designs created in the United States of America, the applicant first obtains a license from the United States Patent and Trademark Office [USPTO] before filing outside of the United States of America.

It is a requirement under the law of the Russian Federation that designs created in the Russian Federation by Russian legal entities or nationals are subject to a security clearance procedure by the Federal Service for Intellectual Property [ROSPATENT] to ensure that the designs do not contain state secrets.

Confirm

- 6 – Top navigation bar
- 7 – Support
- 8 – Language settings
- 9 – Your account settings
- 10 – Logout

A Modern Interface and New Payment Options

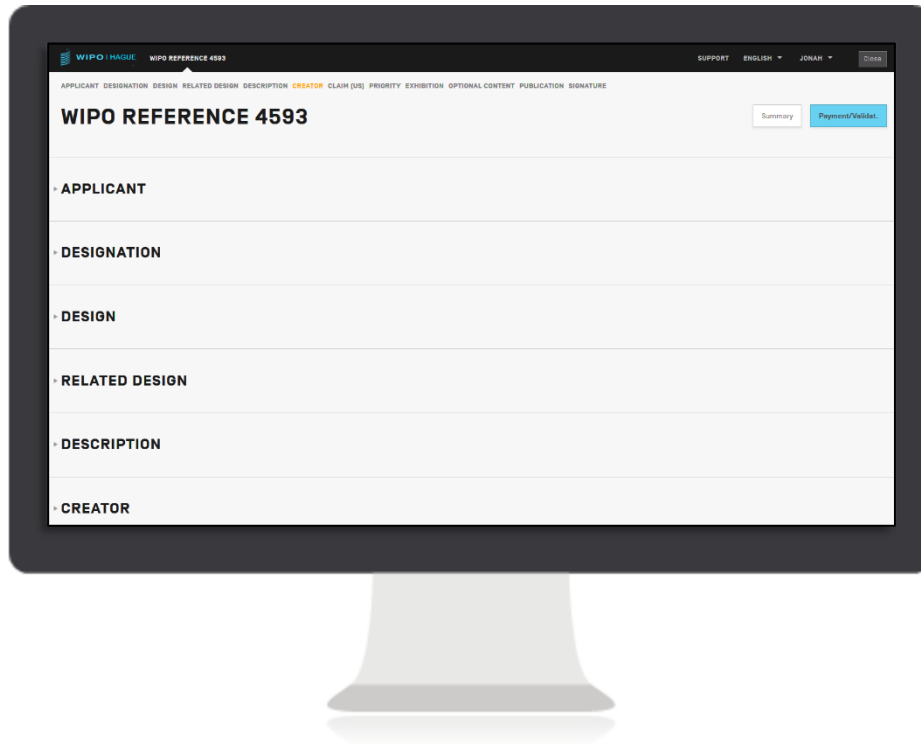

One page design for easy navigation and use

Credit card, debit card, Paypal, current account, or bank transfer

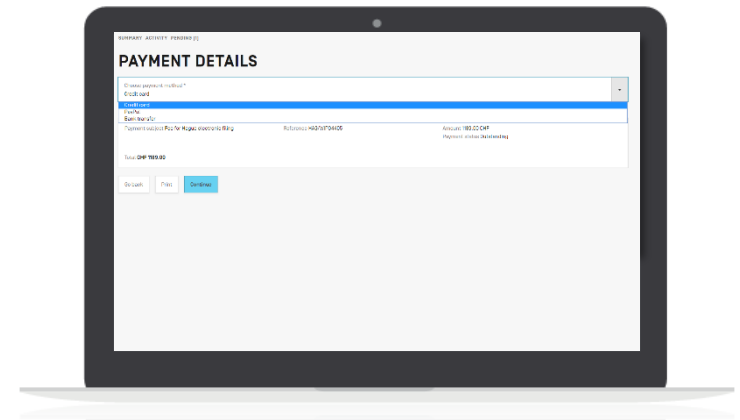

New Hague Information Tools

- New E-service and E-instrument available at www.wipo.int/hague

- **Contact Hague Form**

- Single point of contact for users, while making enquiries, submitting documents or to request a priority document

- **Hague Member Profiles Database**

- Compilation of data;
- Search tool

Contact Hague Form

[Home](#) › [Inside WIPO](#) › [Contact Us](#) › [Hague System](#)

Contact Hague

Use this form to make an enquiry, submit documents or to request a priority document.

Please note: Before selecting "Submit", you must provide an answer for **all** fields (except for "optional" fields).

The International Bureau will **only** provide information concerning a pending application or unpublished international registration to the applicant, holder, or representative.

I'm contacting you to:

- Ask a question
- Request a priority document
- Submit documents

Submit

Hague System Document Upload

Contact Hague

Use this form to make an enquiry, submit documents or to request a priority document.

Please note: Before selecting "Submit", you must provide an answer for **all** fields (except for "optional" fields).

The International Bureau will **only** provide information concerning a pending application or unpublished international registration to the applicant, holder, or representative.

I'm contacting you to:

- Ask a question
- Request a priority document
- Submit documents 1

To submit documents with this form:

- Check the confirmation box below.
- Click the "Upload Documents" button.
- Login to the upload interface with your [WIPO account](#).
- After you login, use the interface to attach and send documents.
- Make sure your reproductions are less than 2MB in size, 300dpi, and in jpg or tiff format.

After you log in:

- All fields are required unless stated they are optional.
- Click the "Upload a form" button.
- Select a document type. If your type is not listed, choose "Reply to an Irregularity".
- Enter your IRN. If you do not have an IRN, enter "000000".
- Enter an optional internal reference.
- If you would like to attach any optional instructions or documents, you may do so.
- Select your user type.
- Enter and confirm your email address.
- If you would like a separate confirmation email for each document you send, check the box.
- Click on the "Submit" button.

Tip: If you do not have a WIPO account, you can easily [create one](#).

Important: Documents will only be accepted in one of the Hague Registry's official languages (English, French, or Spanish).

To correct an irregularity please use the [E-Filing Workbench](#), this form, or the mailing address indicated in the irregularity letter.

I confirm I have read and understand the directions above. 2

3

Access via Contact Hague at:

<https://www3.wipo.int/contact/en/hague>

WIPO account required

WIPO

Home > IP Services > Hague System > Contact Hague Upload

Submit Documents to WIPO

Select user type

Natural person Legal entity

Email address

Send separate email confirmations for each form submitted.

Hague member Profiles Database

[Home](#) › [IP services](#) › [Hague System](#) › [Members](#) › [Hague Member Profiles](#)

Hague Member Profiles

Access a wide range of information on the practices and procedures of [Hague System](#) members. Simply select the member(s) or groups of members of interest to you, and choose the type of information you want to see.

Resources

- [Contracting parties](#) PDF
- [Declarations made under the Hague Agreement](#) PDF
- [User Guide](#)
- [Hague System News](#)

Tip: Select Groups of Members for a fast track to find members which do not allow deferment of publication or allow it for a limited period.

Which member(s) are you interested in?

What type(s) of information are you looking for?

Search

Reset

All members

Groups of Members

- No Deferment
- Limited Deferment

- African Intellectual Property Organization (OA)
- Albania (AL)
- Armenia (AM)
- Azerbaijan (AZ)

All available information

- General Information
- Information on Designated Contracting Party
- Information on Applicant's Contracting Party (Indirect Filing)

Global Design Database

Global Design Database

A world-wide collection of industrial designs data; including WIPO Hague registrations and information from participating national offices.

[Join us for free webinars in 2019](#)

SEARCH BY

Design | Names | Numbers | Dates | Country

Indication of Products ▾ =

Design class ▾ =

Description ▾ =

search ↗

FILTER BY

Source | Designation | Locarno Class | Reg. Year *

CA Designs	171,379	CN Designs	4,944,447	DE Designs	1,152,269	ES Designs	422,943
FR Designs	759,185	GE Designs	2,384	JP Designs	571,482	JO Designs	2,193
MD Designs	10,390	MK Designs	974	MN Designs	2,768	NZ Designs	49,130
US Designs	836,784	ID Designs	48,853	EM Designs	1,194,272	WO Designs	99,304

Display: List ▾ | Sort: Value - asc ▾

filter ↗

1 - 10 / 10,268,757

Display: 10 per page options

1 / 1,026,876

Sort by Reg. Date - desc ▾

NZID
424550
POST OR PILE DRIVER BLOCK
2019-01-16
FARMGEAR LIMITED



NZID
424549
POST OR PILE DRIVER BLOCK
2019-01-16
FARMGEAR LIMITED



NZID
424548
POST OR PILE DRIVER BLOCK
2019-01-16
FARMGEAR LIMITED



Hague Express Database

Hague Express

The Hague Express Database, updated weekly, includes bibliographical data and, as far as international registrations governed exclusively or partly by the 1999 and/or by the 1960 Act(s) of the Hague Agreement are concerned, reproductions of industrial designs relating to published bearing a registration date as from January 3, 1985. International registrations that have lapsed are not removed from the database.

SEARCH BY

Design | Names | Numbers | Dates | Country

Indication of Products ▾ =

Locarno Class =

Description ▾ =

[search](#)

FILTER BY

Designation | Locarno Class | Reg. Year * | Contracting Party * | Expiration *

CH	71,543	BE	57,176	LU	57,173	NL	57,169	BX	57,167	FR	55,740	DE	55,401	IT	51,415	ES	37,830	^
EG	36,015	TN	35,872	MA	32,843	ID	31,029	VA	29,879	AN	28,012	EM	23,802	MC	22,899	LI	22,241	
HU	15,234	TR	12,228	GR	11,700	RO	9,265	SI	9,233	ME	8,338	UA	8,328	RS	8,063	MK	8,054	
KP	7,741	SG	7,653	DD	7,357	MD	7,254	VN	6,291	US	6,288	NO	5,881	BG	5,282	MN	4,657	
SN	4,587	SR	4,480	HR	4,469	BJ	3,831	BQ	3,719	CW	3,719	SX	3,718	GE	3,583	KR	3,453	
JP	3,337	CI	3,015	YU	2,916	KG	2,904	AL	2,447	BZ	2,365	BA	2,305	OM	2,147	AM	2,015	
AZ	1,609	OA	1,077	IS	974	EE	716	TJ	654	LV	601	LT	500	DK	486	NA	463	
SY	448	GA	417	BW	381	GH	338	RU	328	PL	291	FI	284	ST	221	BN		

Display: List ▾ Sort: Count - desc ▾ [filter](#)

1 - 10 / 99,304 [edit columns](#)

10 per page 1 / 9,931

	Reg. No	Holder	Reg. Date	Locarno Cl.	Ind. Prod.	Designations	Image
<input type="checkbox"/>	DM/103839	PIAGGIO & C. S.P.A.	2018-11-15	26-06	1-3. Motorcycle lamps	CH,KR,NO,SG,TR	
<input type="checkbox"/>	DM/103870	SCOTT MUIR	2018-11-14	21-02	1. Folding mountain bike/skate ramp with extension	CA,CH,EM,GB,NO,OA,OM,SG,TR,U	
<input type="checkbox"/>	DM/103841	MP GROUP NV	2018-11-14	30-99	1. Litter box for pets	EM,US	
<input type="checkbox"/>	DM/103799	SAVIAS PLASTIK SANAYI VE TICARET ANONIM SIRKETI	2018-11-14	06-01	1. Chair [seat]	EM	
<input type="checkbox"/>	DM/103838	DK NAVAL TECHNOLOGIES SDN BHD	2018-11-13	12-06	1. Tanker [ship]	SG	
<input type="checkbox"/>	DM/103837	DK NAVAL TECHNOLOGIES SDN BHD	2018-11-13	12-06	1. Tanker [ship]	SG	

Developments in the Legal Framework



Amendments to the Common Regulations Under the 1999 Act and the 1960 Act of the Hague Agreement concerning a safeguard against non-delivery of an electronic communication entered into force on 1.1.2017



The appointment of a representative may be made in the international application. The naming of the representative in the international application at the time of filing shall constitute an appointment by the applicant of such representative. The power of attorney is no longer required at the time of filing since 01.01.2019



Filing the international application via fax is not possible since 01.01.2019



Modes of payment are more flexible for the IB in accepting payments by debit cards or other new forms of payment (online payment system) since 01.01.2019



Entry into force of the twelfth edition of the Locarno Classification on 01.01.2019

Stay up to date with the Hague System

- Visit the Hague System website:

<https://www.wipo.int/hague/en/>

- Enjoy the new E-Services:

- eHague (new E-filing opportunities);
- e-Renewal (sophisticated features for renewals);
- ePay (extended opportunities to pay the fees online);
- Contact Hague (unique portal to communicate with the Hague Registry);
- Hague Member Profiles Database (wide range of information on the practices and procedures of [Hague System](#) members)

- Subscribe to [Hague Notices](#) to be aware about Hague information notices and updates on developments in the Hague System

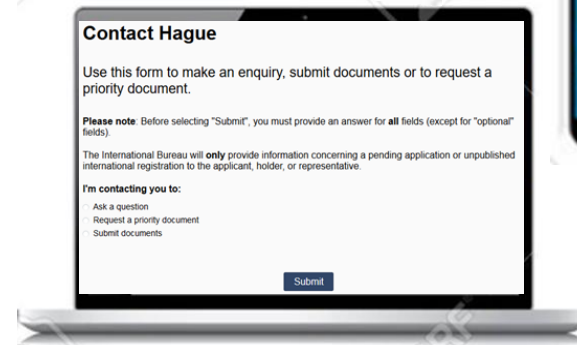

WIPO | HAGUE
The International
Design System

Thank you!

