

The Design Patent in China

**Industrial Design Examination Department,
SIPO of P.R.C.**

Establishment of Design Protection System in China

- **April 1 1985. 04.01**
- **Design is protected along with invention and utility model on the basis of Chinese Patent Law.**

Developments of the Chinese Design Protection System

China acceded to

- **the Paris Convention on November 14 1984**
- **the Locarno Agreement on September 19 1996**
- **the World Trade Organization (WTO) on December 10 2001 (undertaking the obligations of the TRIPS agreement, of course, its provisions of design protection as well).**
- **Not yet acceded to Hague Agreement**

China's Present Design Protection System

Protection Term

10 years from the date of filing.

China's Present Design Protection System

Design Examination System

The Application Documents

- Request
- Drawings or photographs
- Brief explanation
- Other relevant documents

Examination System

- Preliminary Examination
 - First-to-file Rule

Three-dimensional design



right view



front view



left view



top view



back view



Space diagram

Plane design:



front view



back view

Plane design:



front view

The applicant shall submit the orthographic projection view of the side concerned if the main points of the design of the product involve the view of one side only.

China's Present Design Protection System

Design Examination System

Design of Products in Set

- Belonging to the same subclass
- Being sold at the same time
- Being used at the same time
- Having the same designing concept

Examples:

- A set of coffee utensils consisting of coffee cup, coffee pot, milk pot and sugar pot.



The four-piece beddings consisting of bedspread, sheet, pillow case and cushion case.

Design of Products in Set :

床上用品



1 front view



2 front view



3 front view



4 front view

China's Present Design Protection System

Design Examination System

Check According to Article 5 of Law

- **No patent right shall be granted for any invention-creation that**
 - (1) is contrary to the laws of the state;**
 - (2) is contrary to the social morality;**
 - (3) is detrimental to public interest.**

Examples:

Takes the national flag or national emblem as the pattern.

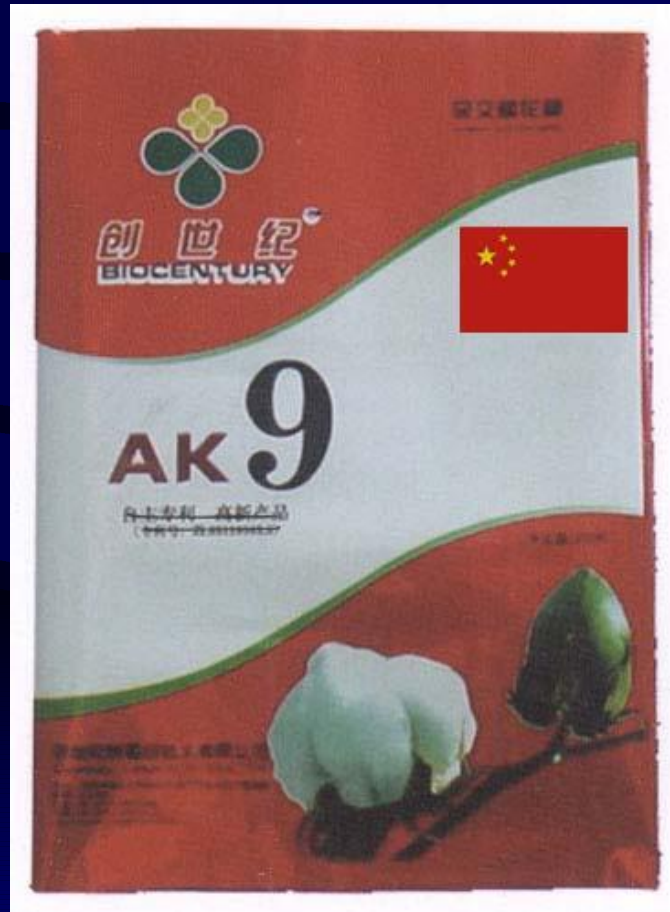

Name:
packing bag

- Takes the Olympic symbol or relevant symbols as the pattern.



front view (packing box)

Subject Matter for Which No Design Patent Shall Be Granted

- Any fixed building, bridge and the like which depends on their specific geographic conditions and cannot be rebuilt elsewhere



- **Any product which has no fixed shape, pattern or color**



decoration



cocktail

- **Any component part of the product which cannot be partitioned or sold or used separately**



handle of vase



vase

- **Any product consisting of several component parts and the component part is not a product which has any value of independent use**

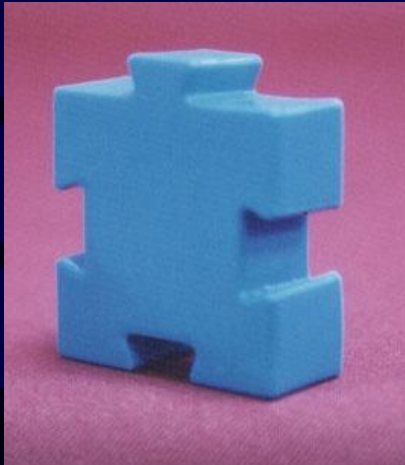

a plug-in piece



toy

- **Any product which cannot be perceived by the visual sense or the shape, pattern or color of which is difficult to be determined with the naked eye**

- **Any design for which the protection is sought is not the design of the state of normal product**



a flower made with a handkerchief



handkerchief

- **Any design the main body of which is the original shape, pattern or color of the natural object**



**a sculpture
made with root**

- **Any work which belongs wholly to the field of fine arts**



traditional Chinese painting

- **Any design which is constituted only by geometric shapes or patterns of common sight in the field of the relevant product**

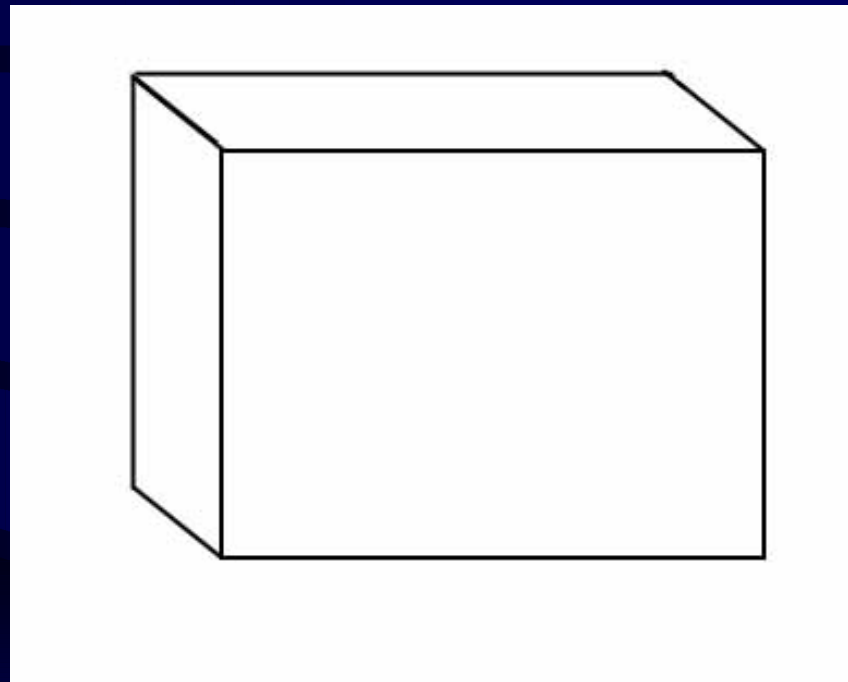

packing box

- **The sound and meanings of the words and numbers**

- The pattern of design only displays when the product is electrified



The Numbers of Applications for Patents for Industrial Design (1985-2005)

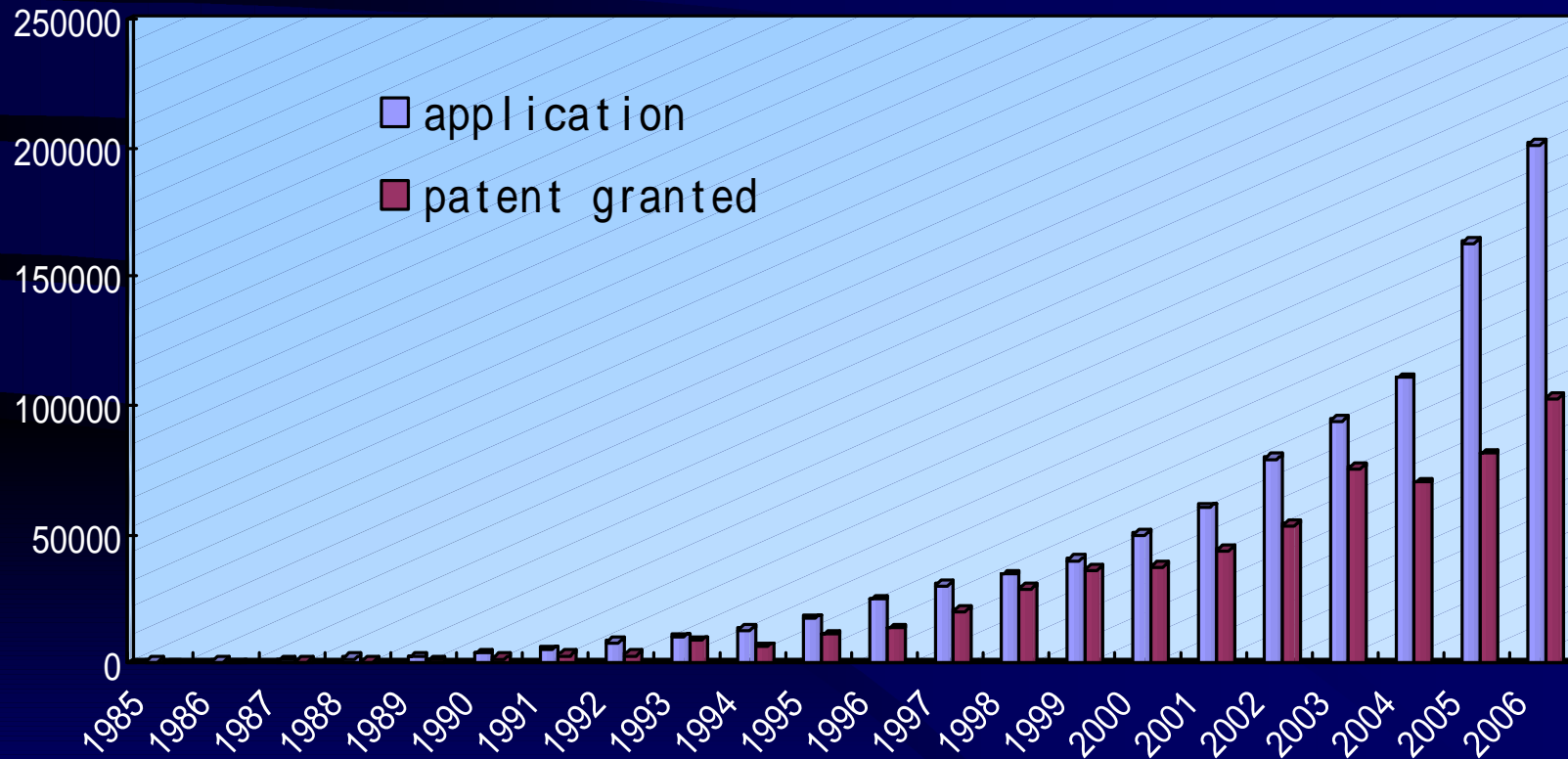

Applications for Design Received from Home and Abroad, 2005

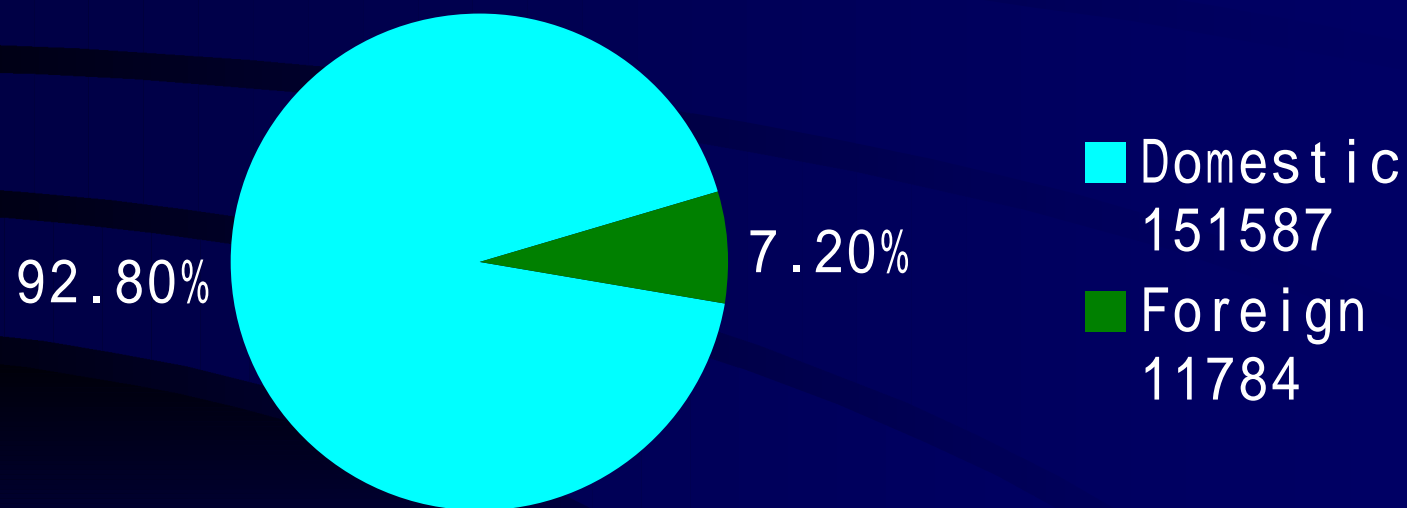

General Information of the Design Examination Department

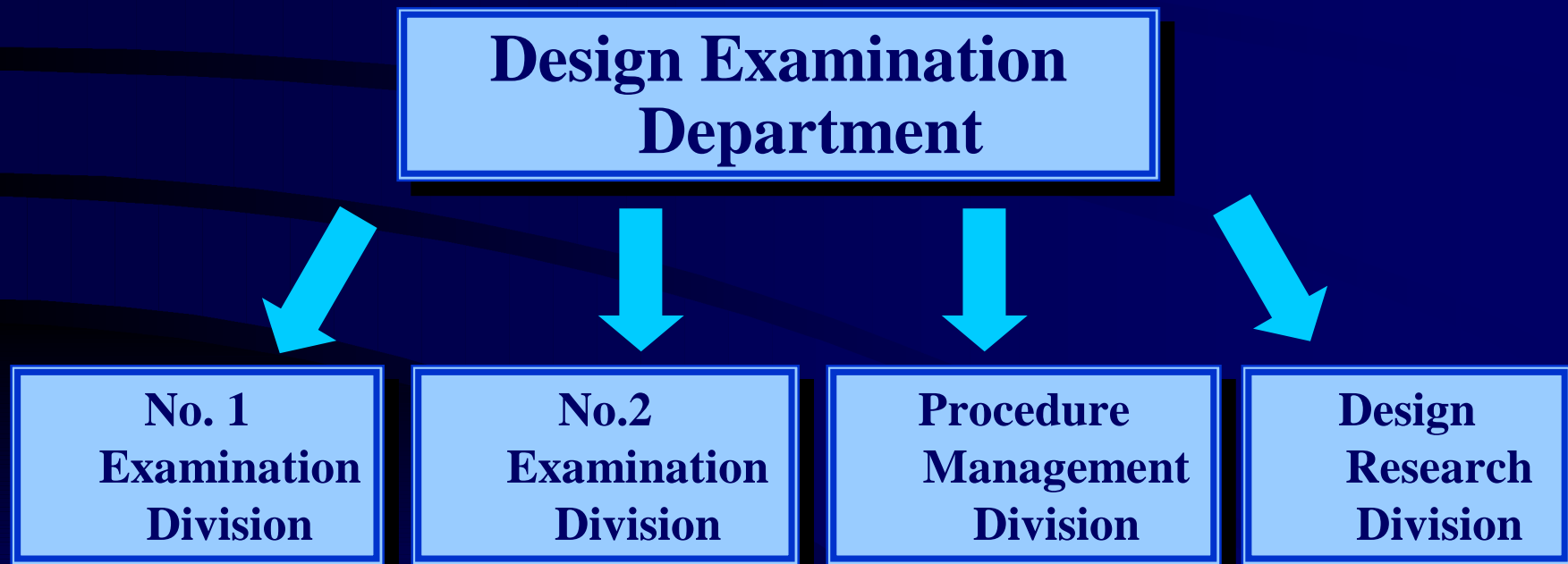

Post Grant Procedure for Design Patents

- **Reexamination Procedure**
- **Invalidation Procedure**
- **Administrative reconsideration Procedure**
- **Administrative lawsuit Procedure**
- **legal proceedings for infringement lawsuit**

Statistics of the Design Reexamination and Invalidation

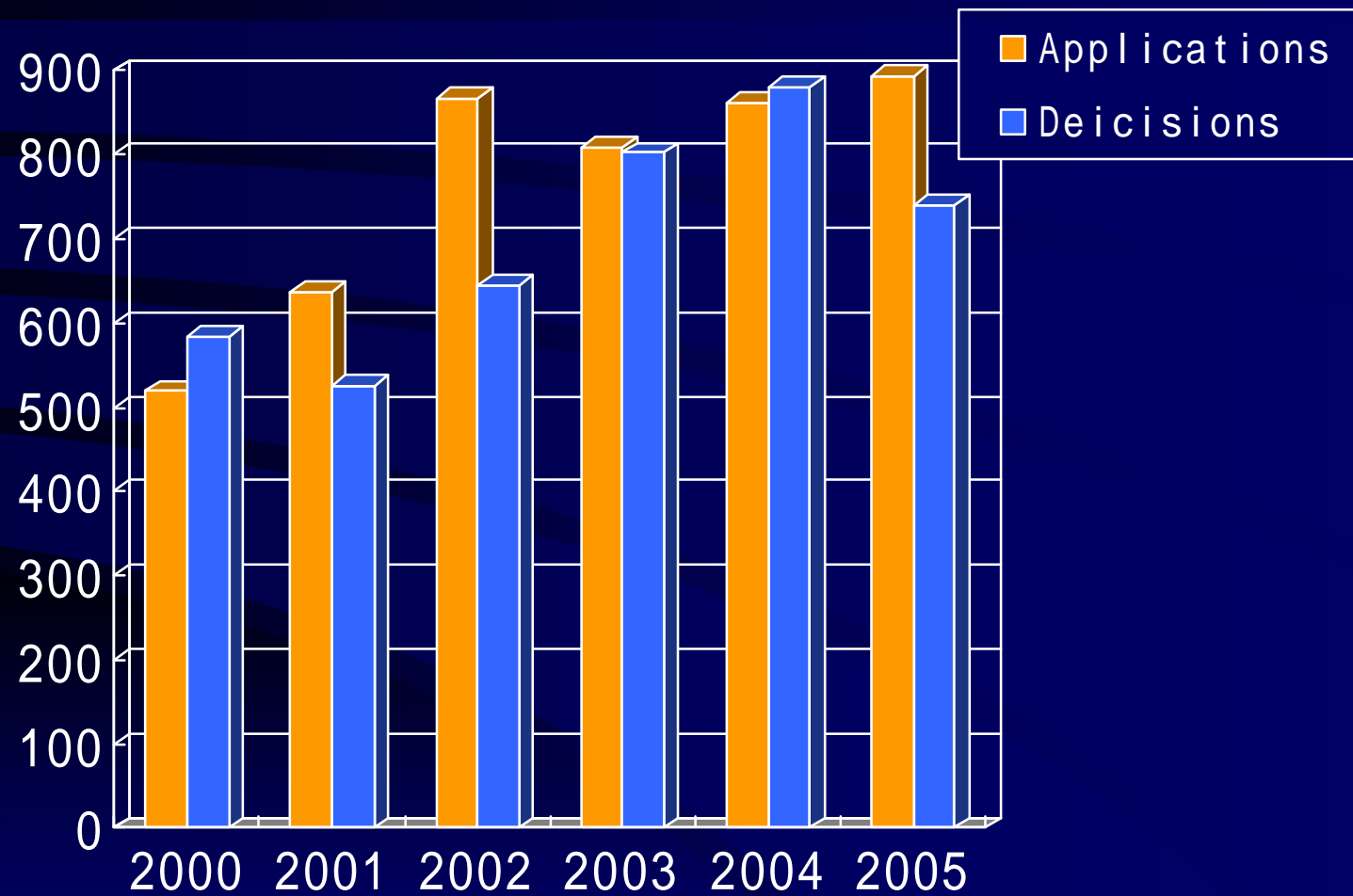

Legislative Issues and Trends for Development

- The third Amendment of Law
- Examination System
- To Establish Search Database
- Research about Hague Agreement

THANK YOU !