



WIPO | HAGUE

The International
Design System

International Application and Examination

Seminar on the Hague System for the International Registration of Industrial Designs

Geneva
November 13, 2014

Kateryna Gurinenko, Examiner
Operation Services, The Hague Registry

Content

- 1. Introduction
- 2. Preparation of the filing of an international application
- 3. Requirements concerning the reproductions
- 4. Amendments of the administrative instructions
- 5. Examples
- 6. Republic of Korea

Introduction - « Good to know »

- NO national/regional application or registration required
- It is possible to designate the applicant's Contracting Party
- NO subsequent designation
- Declarations made by the Contracting Parties to be taken into consideration

Introduction - « Good to know »

- The majority of the international applications is filed:
 - **directly** with the International Bureau (and NOT through the Offices of Contracting Parties)
 - via the *E-filing* interface

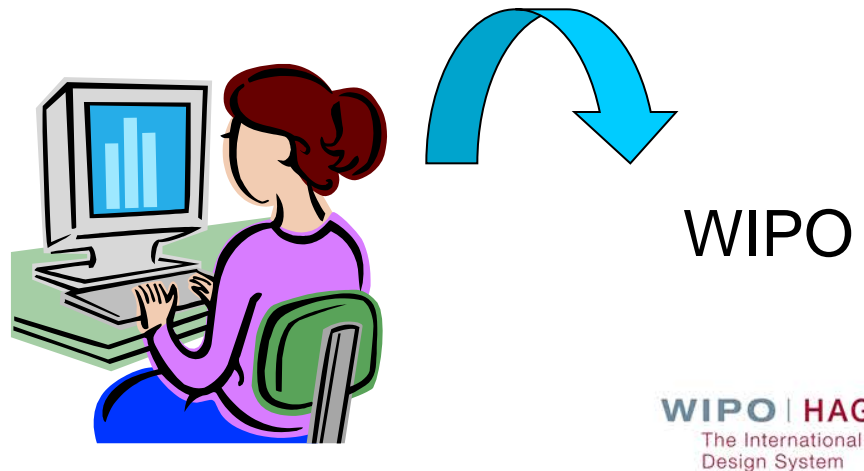

Preparation of the Filing of an International Application

- **Entitlement** to file an international application
- **Languages**
- **Representation** before the International Bureau of WIPO

Who can file an international application?

- **Hague System = « closed » system**

- **Link** with a Contracting Party (CP)
(State of origin / Applicant's Contracting Party)

- **Criteria:**

- Nationality
- Domicile
- Real and effective industrial or commercial establishment
- Habitual residence (*only* under the 1999 Act)

Acts in force

- Two Acts are currently in force:
 - Hague Act (1960)
 - Geneva Act (1999)

Hague Union

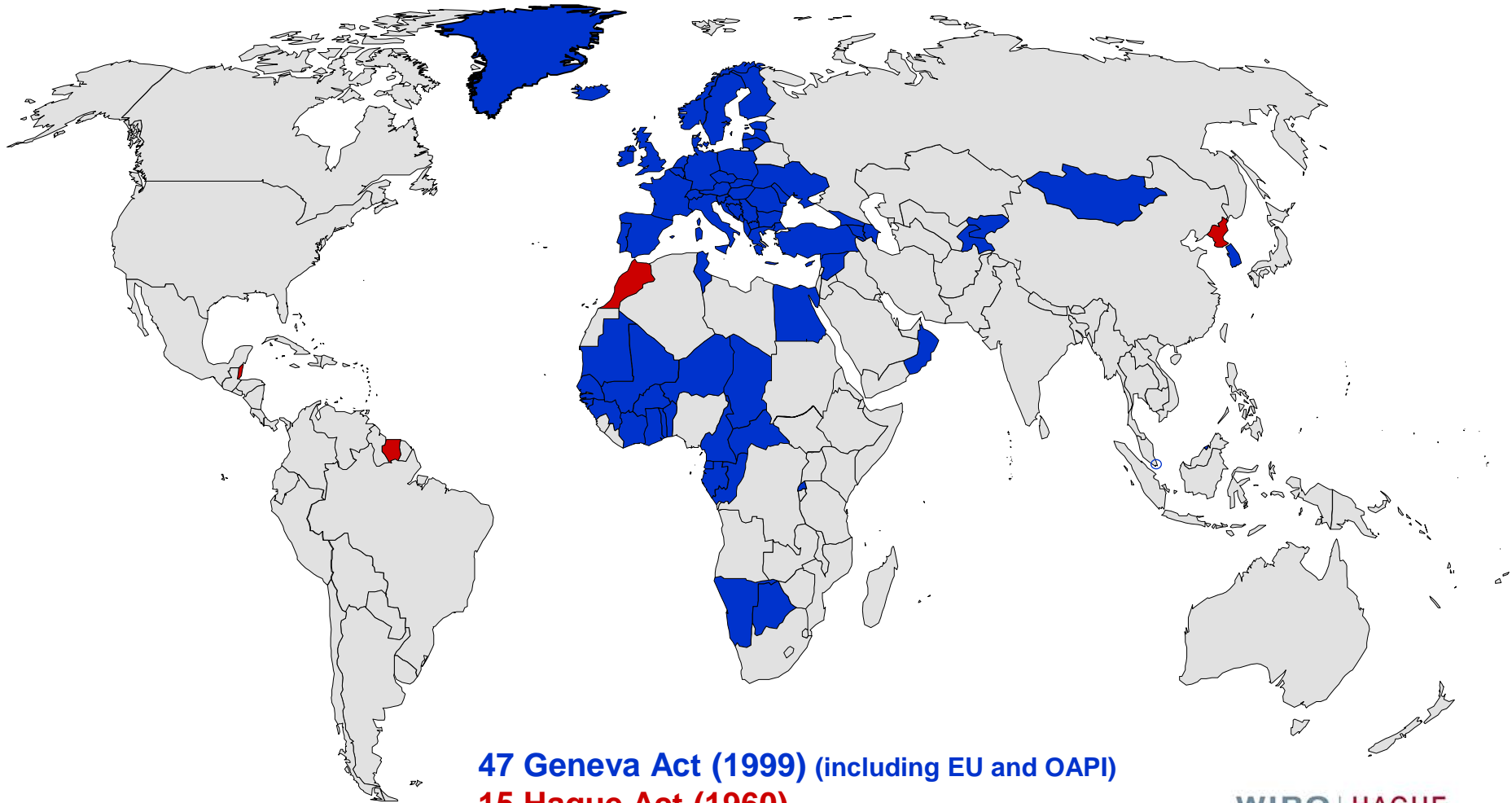

47 Geneva Act (1999) (including EU and OAPI)

15 Hague Act (1960)

62 Contracting Parties

Which act(s) govern(s) the international application?

Applicant CP

Designated CP

Denmark

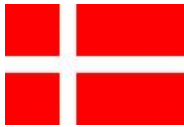

1999 Act

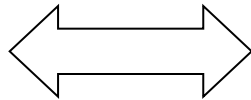

Morocco



1960 Act

IMPOSSIBLE

NO common Act

Denmark



1999 Act

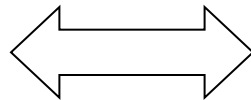

France



1960/1999 Act

POSSIBLE

- One of the advantages of the « e-filing » → The system automatically determines the Contracting Parties that may be designated taking into account the information relating to the entitlementment

Entitlements **

Nationality	UA - Ukraine (60/99)
Domicile	CH - Switzerland (60/99)
Real and effective industrial or commercial establishment	Select a Contracting Party
Habitual residence	Select a Contracting Party

(**) Indicate at least one entitlementment

Applicant's Contracting Party (ACP)

Applicant's Contracting Party

Select a maximum of 1 Contracting Party

- CH - Switzerland (60/99)
- UA - Ukraine (60/99)

Languages – General principle

- Rule 6 of the Common Regulations
- **English / French / Spanish** (since April 1, 2010)
- Languages:
 - International application
 - Communications
 - Recording and publication

Requirements concerning the reproductions

Legal Framework

- Article 5 (1960 Act) / Article 5 (1999 Act)
- Rule 9 of the Common Regulations
- Administrative Instructions – Section 401- 405

Reminder: no refusals relating to the form of the reproductions!

Requirements concerning the reproductions

Common for paper and e-filing

- Industrial design alone
- Industrial design has to be shown against a neutral/plain background
- Technical drawings, with axes and dimensions are **not** acceptable
- Explanatory text or legends (in the reproduction) are **not** acceptable
- Edges cut at right angles

Amendments of the administrative instructions

(in force on July 1, 2014)

- Section 402: Representation of the industrial design
- Section 403: Disclaimers and matter that does not form part of the industrial design or the product in relation to which the industrial design is to be used
- Section 405: Numbering of reproductions and legends

EXAMPLES

Minimum and maximum sizes of dimensions (Section 402(b))

- The dimensions of the representation of each design may not exceed 16 x 16 cm;
- for all reproductions
- One of the dimensions of the representation of each design must be at least 3 cm:
Before – for all reproductions
Now – at least for one of the reproductions

Enlarged views



1.5

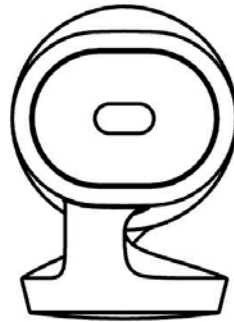

1.6



1.7

DM/084081 "Pen"

Legends (indications of views) (Sections 402(c)(ii) and 405(c))















- Legends may NOT be shown in a reproduction.
- Legends may be provided in association with the numbering of the reproduction in a specific item.

Legends (e.g., "front view", "perspective view", "enlarged view") provided in the above item will be published under INID code (55), separately from a "description (of the characteristic features of the design)" .

Legends (indications of views): E-Filing Interface

* Extensions allowed: jpg and tif

Verify Cancel

No. of repros.	File name	Legend (optional)	View	Actions
1	m001_001.jpg	Front view		
2	m001_002.jpg	Front view		
3	m001_003.jpg	Back view		
4	m001_004.jpg	Top view		
5	m001_005.jpg	Bottom view		
6	m001_006.jpg	Nothing		
7	m001_007.jpg	Nothing		

↑ ↓

Courtesy of Audi AG; DM/083775 “Motor vehicle”

Legends (indications of views): paper form

(b) Reproductions (legends) (optional)

Associate the number in the margin of your reproduction with the corresponding code:

1 Perspective; 2 Front; 3 Back; 4 Top; 5 Bottom; 6 Left; 7 Right; 8 Reference; 9 Unfolded; 10 Exploded; 11 Cross-sectional;
12 Enlarged; 00 Other (limited to 50 characters)

(example)

No.	Code	Other (indicate code 00)
1.1	1	

No.	Code	Other (indicate code 00)	No.	Code	Other (indicate code 00)	No.	Code	Other (indicate code 00)

Legends: 7 Basic views

1.1

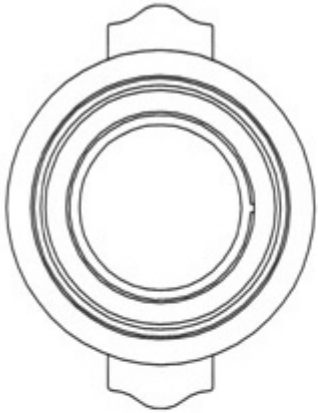

1.2

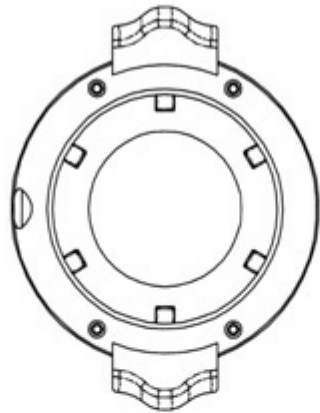

1.3

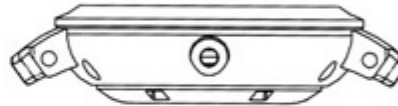

1.4



1.5

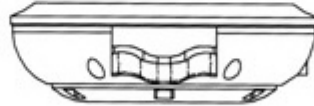

1.6

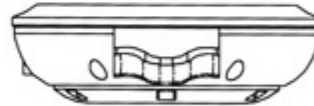

1.7



DM/083519 "Watch case"

Legends: Some example of views

Cross section view

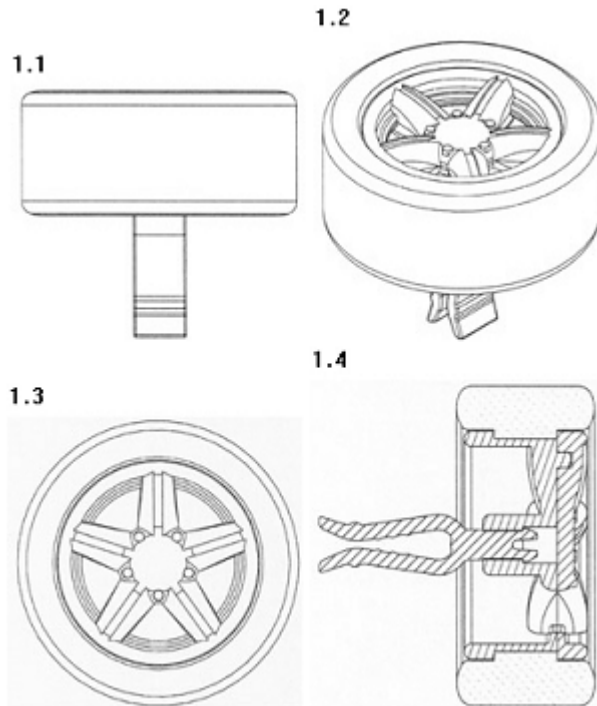

Enlarged view



DM/084170 “Air deodorizing device”

DM/084607 “Tire”

Legends: Some example of views

Exploded view

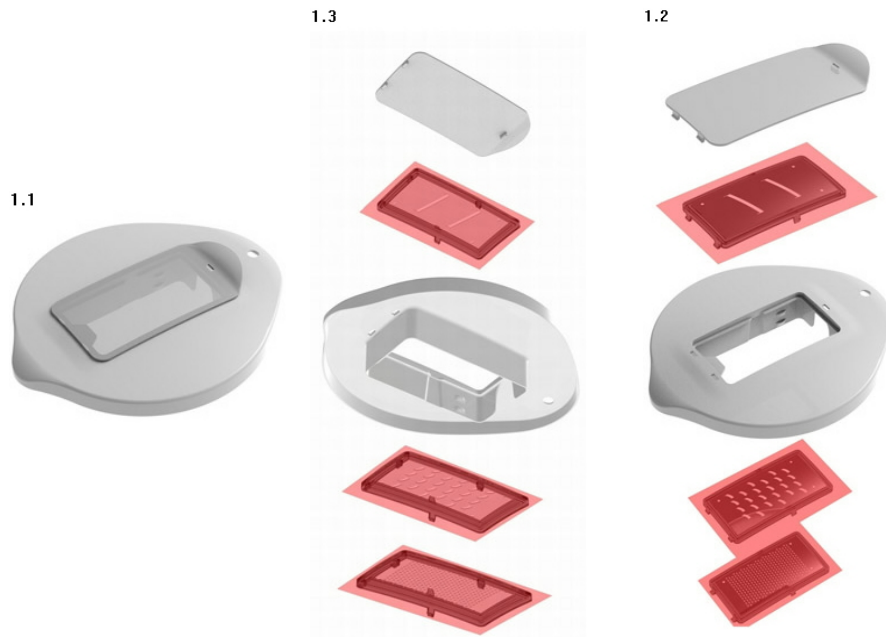

Unfolded view



DM/080877 "Lid [household]"

DM/078316 "Packaging for tea "

Disclaimer (Section 403(a))

- "Disclaimer" of protection for part of the industrial design may be indicated:
 - in the description (by text), and/or
 - by means of dotted lines, broken lines, or coloring.

Disclaimer by coloring has been accepted. The provision was modified to reflect that long-standing practice.

Disclaimer by coloring and description

2.1



2.2



2.3



“The blue marked parts of designs 2 to 4 are not coming into the scope of the industrial design (disclaimer)”

DM/080861 “Vehicle bodywork”

Disclaimer by means of dotted lines and description

1.1

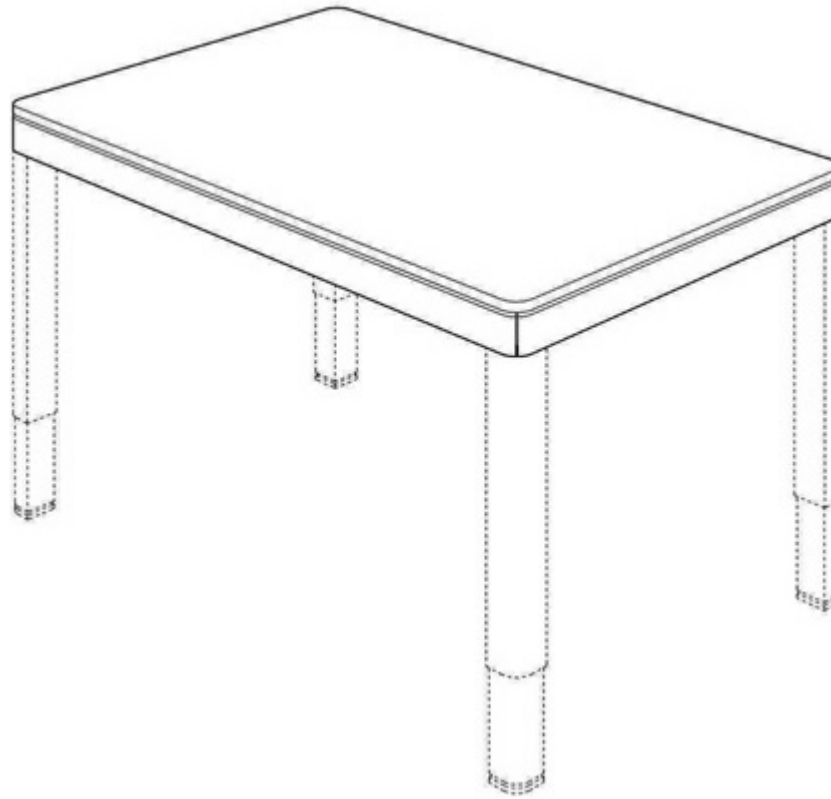

DM/081700 "Desk"

Disclaimer (Section 403(b))

(b) Notwithstanding Section 402(a), matter that does not form part of the industrial design or the product in relation to which the industrial design is to be used may be shown in a reproduction if it is indicated in accordance with paragraph (1); (in force on July 1, 2014)



DM/082846 “Bags”

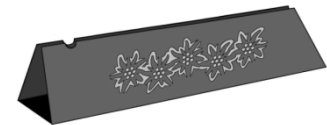
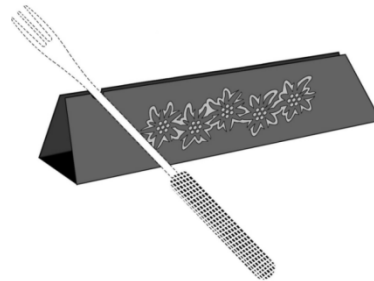

DM/080221 “Cutlery holder”

Presentation of reproductions

Color or B&W

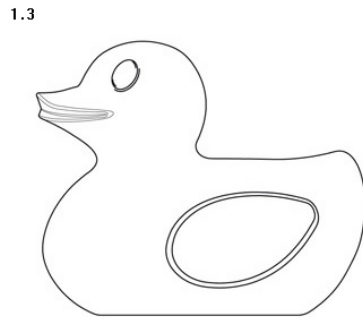

DM/084694 "Outdoor and indoor furniture with integrated lights"

Different colors different designs

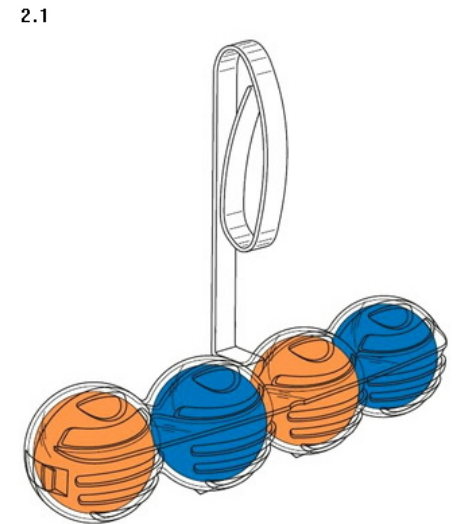
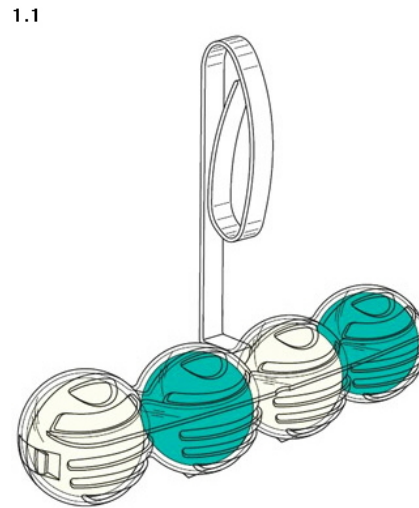

DM/078588 "Lavatory cleansing blocks"

Representation of the industrial design

■ **The following shall not be accepted:**

- Accessory, person or animal;
 - Technical drawings, particularly with axes and dimensions;
 - Explanatory text or legends in the representation
- Merging should be at least 5 millimeters
 - Cut at right angles
 - Shown against neutral background
 - Correct numbering

Representation of the industrial design



1.1

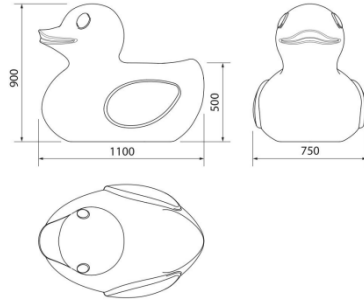

1.2

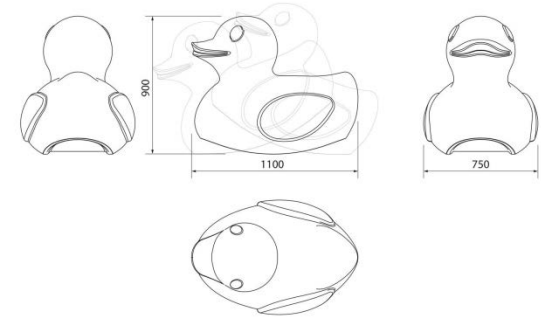

2.1



1.3

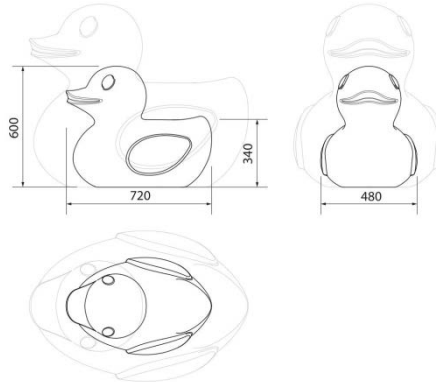

1.4

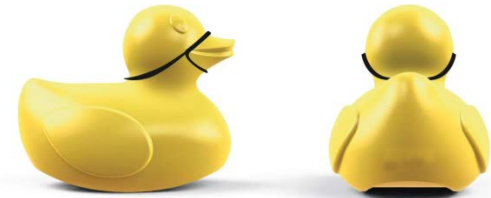

2.2



DM/084694 “Outdoor and indoor furniture with integrated lights”

Representation of the industrial design



1.1



1.2



2.1

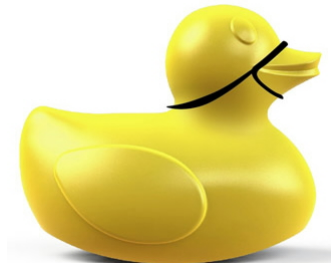

2.2

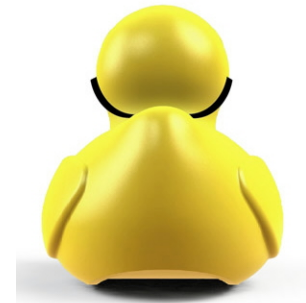

1.3

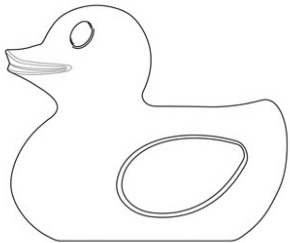

1.4

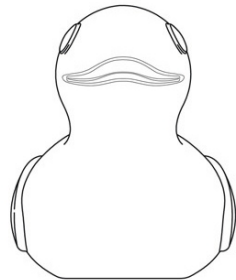

2.3



DM/084694 "Outdoor and indoor furniture with integrated lights"

Unacceptable product indication

DM/079484

~~1.-2. “Logos, graphic elements”~~

¹
NEO
TOOLS

1. Logo

2. Surface patterns

Irregularity Letter:

The indication of the product or products, which constitute the industrial designs 1. Logos, graphic elements (please specify whether the design is logo or graphic symbol) is not appropriate. In order to remedy this irregularity, please indicate in writing the identification of the product(s), preferably by using the terms appearing in the list of goods of the International Classification Note that all the products should be listed under the same class of the International Classification.

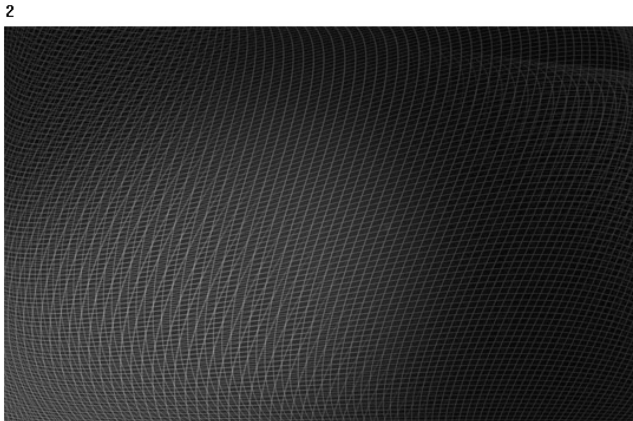

Deadline to response: 3 months

Locarno classification: Unity of class

(class 6)

2.2



“Chair”

3.1



“Cabinet”

7.1



“Dining table”

13.1



“Sofa”

21.1



“Corner table”

DM/083137

Locarno classification: No unity of class

Class 12



DM/081329

Class 6



DM/073710

Class 26



DM/084440

Republic of Korea

Hybrid national system

- Non-novelty examination
 - Class 2: clothing etc.
 - Class 5: textile etc.
 - Class 19: stationery etc.

- “*Ex-Officio*” novelty examination for all other classes
 - Designs in Class 32 cannot receive protection

Hybrid system in the Hague System

■ Designation fee

- Level 3 of Standard DF: Classes 2, 5, 19
- Individual DF: all other classes

■ Refusal period

- 6 months: Classes 2, 5, 19
- 12 months: all other classes

Related designs (Section 407)

- Indication of “principal design” in the application form
 - specifying “related designs”
 - paper form: Annex A to DM/1

- *Optional element, no examination of the contents*

Possible related designs: existing example



DM/082411 "Wristwatches"

New element: declaration concerning exception to lack of novelty (Section 408(c))

- "Declaration" in the application form
 - paper form: Annex B to DM/1
 - possible indication of designs concerned

 - "Supporting document"
 - E-filing: uploading
 - paper form: attachment to Annex B
- *Optional elements, no examination of the contents*

New trend: specific views

- Declaration under Rule 9(3)
formal requirements as to “views”

for a set of articles:

- one view showing the whole set,
- views showing each component

for typefaces:

- view showing all the characters,
- view showing a sample sentence,
- view showing typical characters

Kateryna.Gurinenko@wipo.int
<http://www.wipo.int/hague/en>