



**WIPO | HAGUE**

The International  
Design System



# The Hague System for the International Registration of Industrial Designs

# Industrial Designs



DM/074502



DM/083330



DM/081900

# Why Protect Industrial Designs?

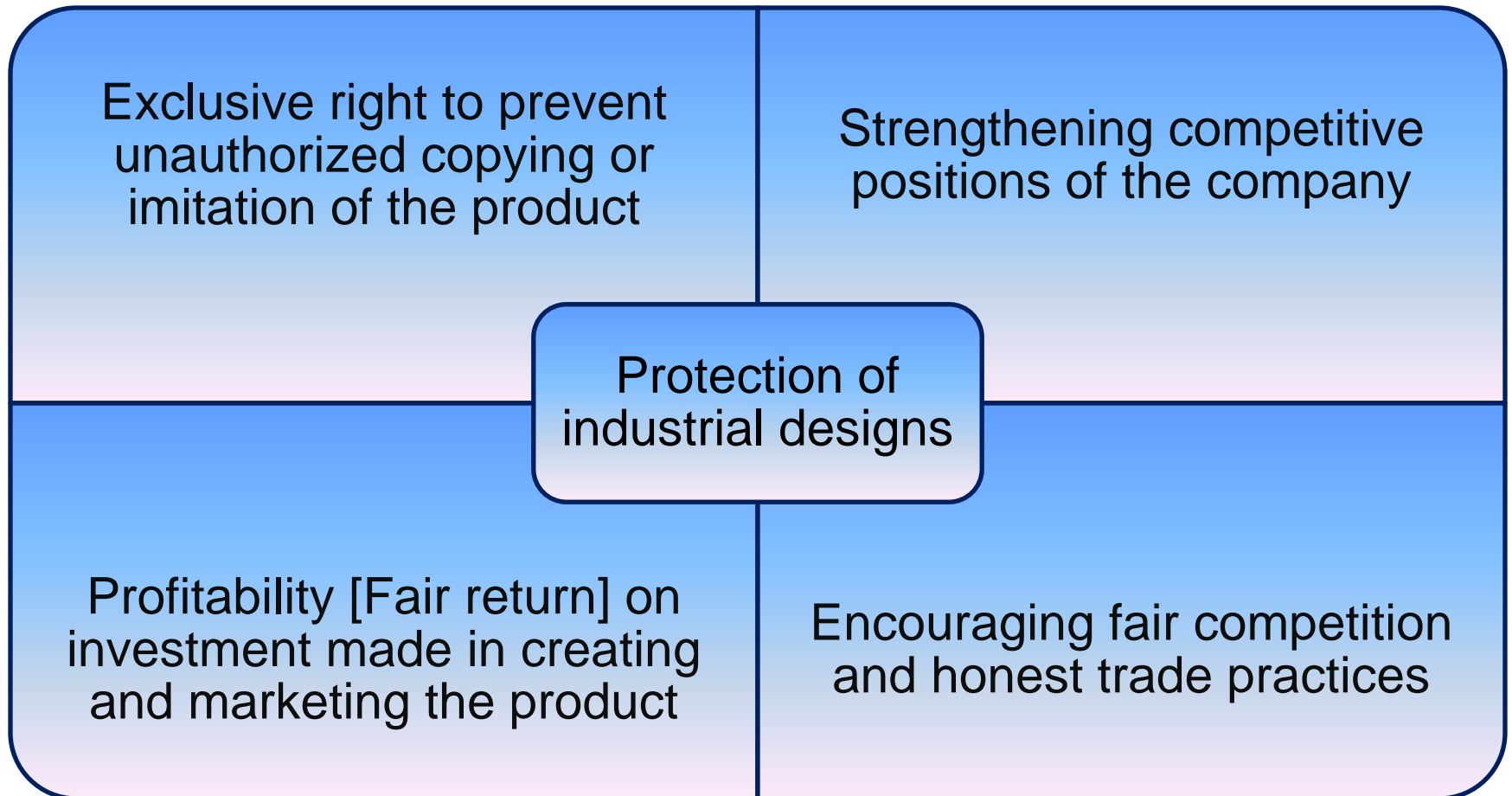

# General Overview of the Hague System



Basic features and advantages



Legal framework



Going global – geographical scope



Some statistics



Latest developments and  
upcoming features



# Basic Features and Advantages of the Hague System

# Hague System: a simple but timeless concept

The centralized acquisition and maintenance of industrial design rights by filing a single international application for a single international registration with effect in one or more designated Contracting Parties



# Independent filings vs. Hague Route

## Direct/Paris Route

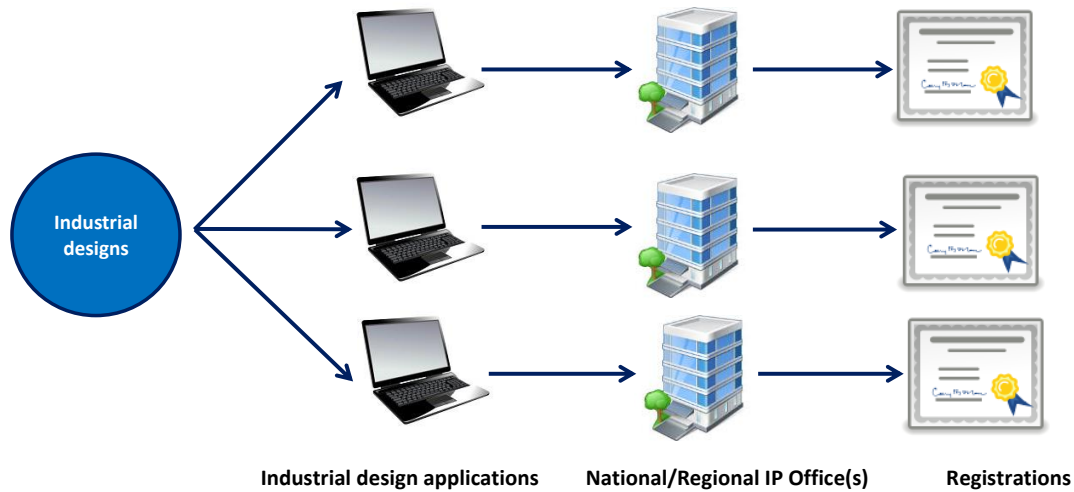

## The Hague System



# Who Can Use the System?

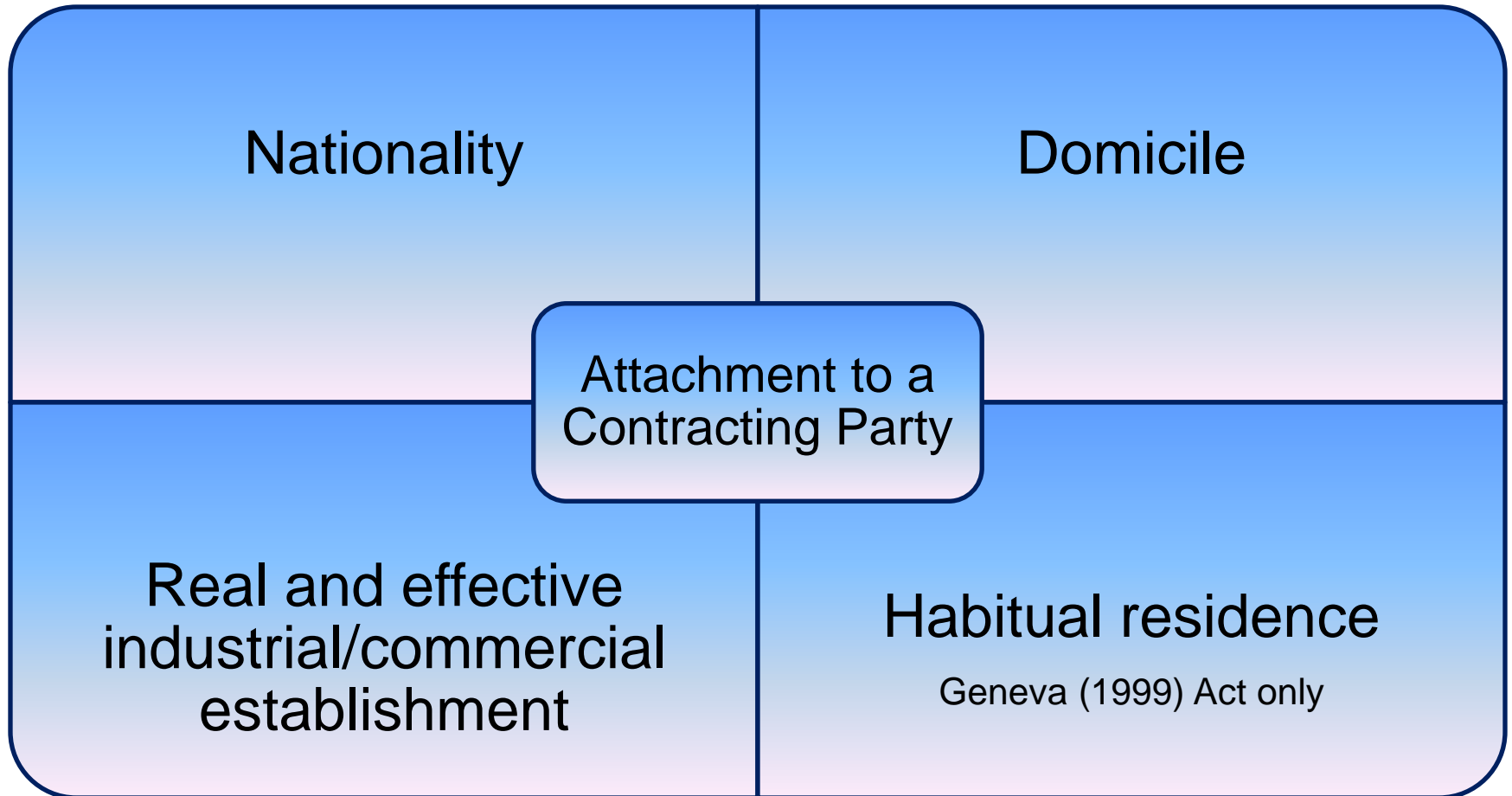



# Main Features of the Hague System



## **Simplicity**

The Hague System enables holders to obtain protection for their designs with a minimum of formality



## **Cost-effectiveness**

Payment of a single set of fees in one currency



## **Efficiency**

Considerable facilitation of the subsequent management of the registration



## **Flexibility**

Right holders have more opportunities in targeting national, regional or global markets

# What is the Hague System?

## One to many relationships

- File a single international application for a single international registration in which one or more Contracting Parties are designated

## “Bundle of rights”

- If no refusal, the resulting international registration has the effect of a grant of protection in each designated Contracting Party

# The Hague System is a Procedural Arrangement

Issues such as:



the conditions for protection



the refusal procedure to be applied when deciding whether a design may be protected



the rights which result from protection

are governed by the law of each Contracting Party designated in an international registration

# The International Application

In English, French or Spanish

May be filed directly with the International Bureau through the E-filing interface but also on paper

May comprise several different designs up to a maximum of 100 if they belong to the same class of the International Classification (Locarno)

One set of fees (in CHF) is to be paid

# The Hague System Procedure: Role of the International Bureau

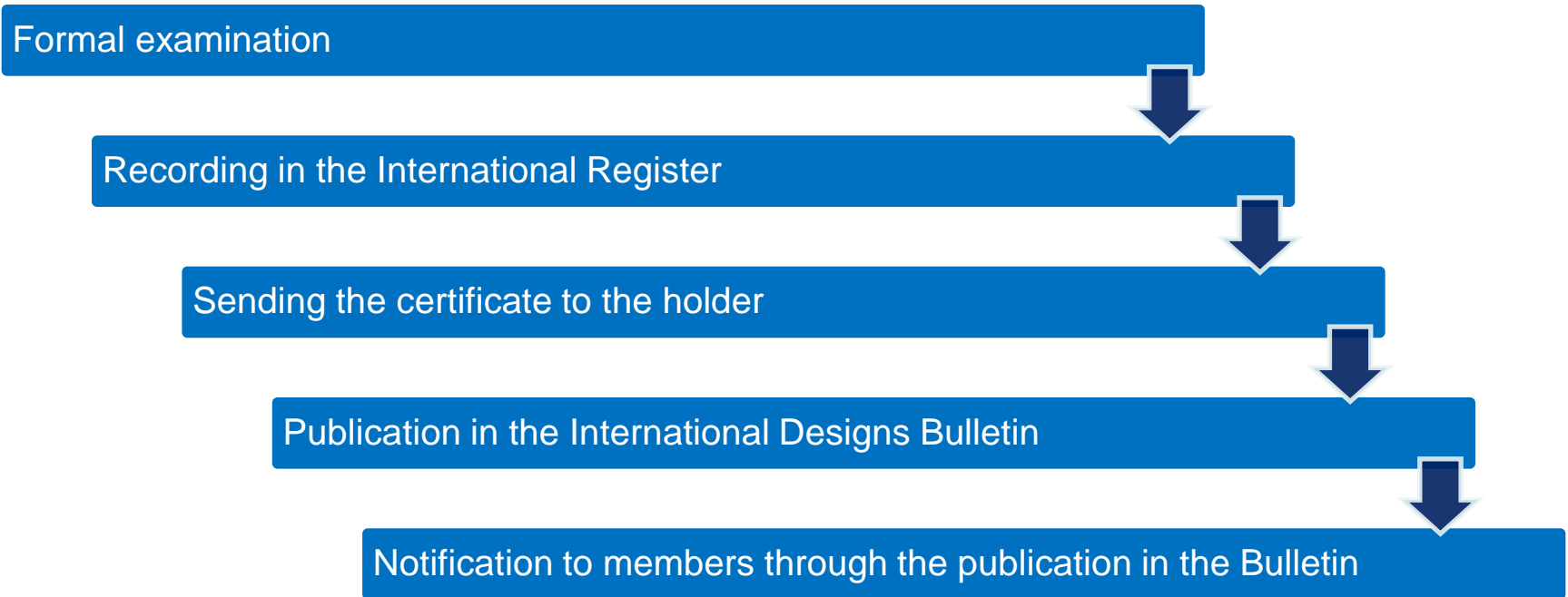

If the International Bureau finds that the international application does not fulfill the applicable requirements, it invites the applicant to make the required corrections within three months from the date of invitation sent by the International Bureau.

International registration has the same effect as a regularly-filed application in all designated Contracting Parties.

# The Hague System Procedure (II)

## Refusal by a designated Contracting Party

on same substantive grounds as for national/regional filings

must be communicated within time limit

effect limited to territory of the member that has refused

## International registration (where not refused)

no refusal = same rights as a local design registration



a bundle of independent national/regional rights

advantages of central management



# The Hague System Procedure (III)

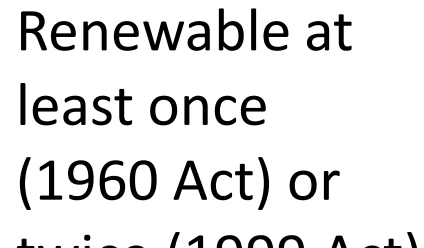

Duration of protection:  
five years

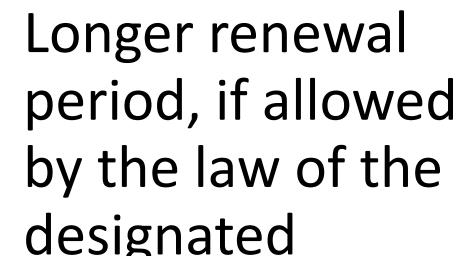

Renewable at least once (1960 Act) or twice (1999 Act)



Longer renewal period, if allowed by the law of the designated Contracting Party

# General Advantages of the Hague System



## Hague System (international route)

one Office for filing  
one language  
one currency  
one international registration  
one renewal  
one modification  
foreign attorney or agent  
(first needed if refused)

## National/regional route

many Offices for filing  
many languages  
many currencies  
many registrations  
many renewals  
many modifications  
foreign attorney or agent  
(first needed at filing)





# Legal Framework

# Hague Agreement

```
graph TD; HA[Hague Agreement] --- HA1[Hague Act (1960)]; HA --- HA2[Geneva Act (1999)];
```

Hague Act (1960)

Geneva Act (1999)

- **Common Regulations (1996), last revised: January 1, 2017 (in force)**
- **Administrative Instructions (2002), last revised: July 1, 2014**
- **National Laws and Regulations**



# Going Global – Geographical Scope of the Hague System

# Hague Union

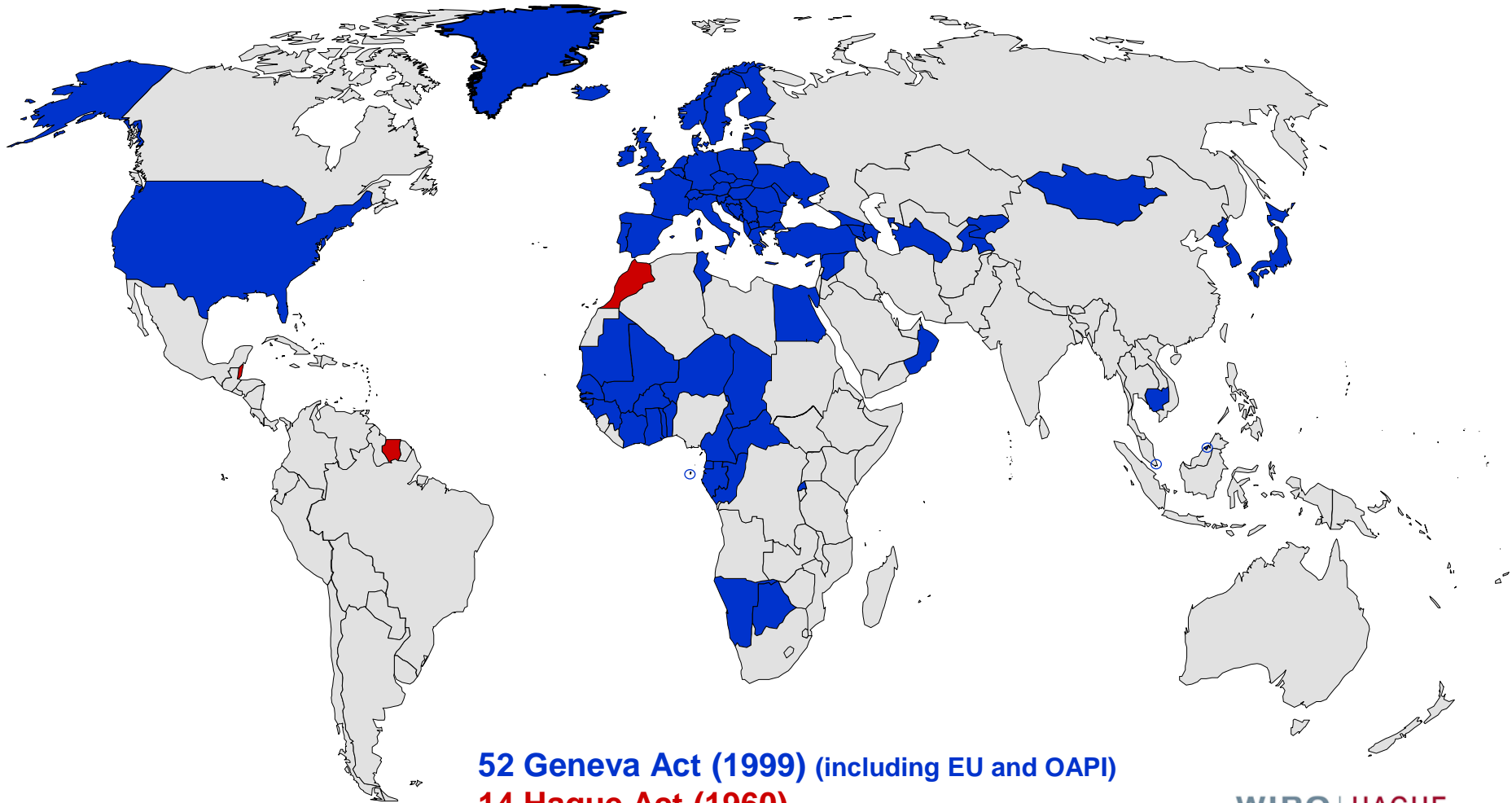

**52 Geneva Act (1999) (including EU and OAPI)**

**14 Hague Act (1960)**

---

**66 Contracting Parties**

# Hague Union Members according to the most recent applicable Act

## Geneva Act (1999)

•African Intellectual Property Organization, Albania, Armenia, Azerbaijan, Bosnia and Herzegovina, Botswana, Brunei Darussalam, Bulgaria, Cambodia, Croatia, D.P.R. of Korea, Denmark, Egypt, Estonia, European Union, Finland, France, Georgia, Germany, Ghana, Hungary, Iceland, Japan, Kyrgyzstan, Latvia, Liechtenstein, Lithuania, Monaco, Mongolia, Montenegro, Namibia, Norway, Oman, Poland, Republic of Korea, Republic of Moldova, Romania, Rwanda, Sao Tome and Principe, Serbia, Singapore, Slovenia, Spain, Syrian Arab Republic, Switzerland, Tajikistan, the former Y.R. of Macedonia, Tunisia, Turkey, Turkmenistan, Ukraine and the United States of America (52)

## Hague Act (1960)

•Belgium, Belize, Benin, Côte d'Ivoire, Gabon, Greece, Italy, Luxembourg, Mali, Morocco, Netherlands, Niger, Senegal and Suriname (14)

# Geneva Act (1999)

## Recent Accessions



The Kingdom of Cambodia  
(November 25, 2016)



D.P.R. of Korea  
(June 13, 2016)



Turkmenistan  
(March 16, 2016)



United States of America  
(February 13, 2015)



Japan  
(February 13, 2015)



Republic of Korea  
(March 31, 2014)

## Potential Accessions



China



Russian Federation



Morocco



ASEAN countries



Israel



Canada



Mexico



Madagascar



United Kingdom

# Current and Foreseen Coverage



Coming soon !



## Some Statistics



# Hague Membership Status as of December 31, 2016 (by most recent Act)

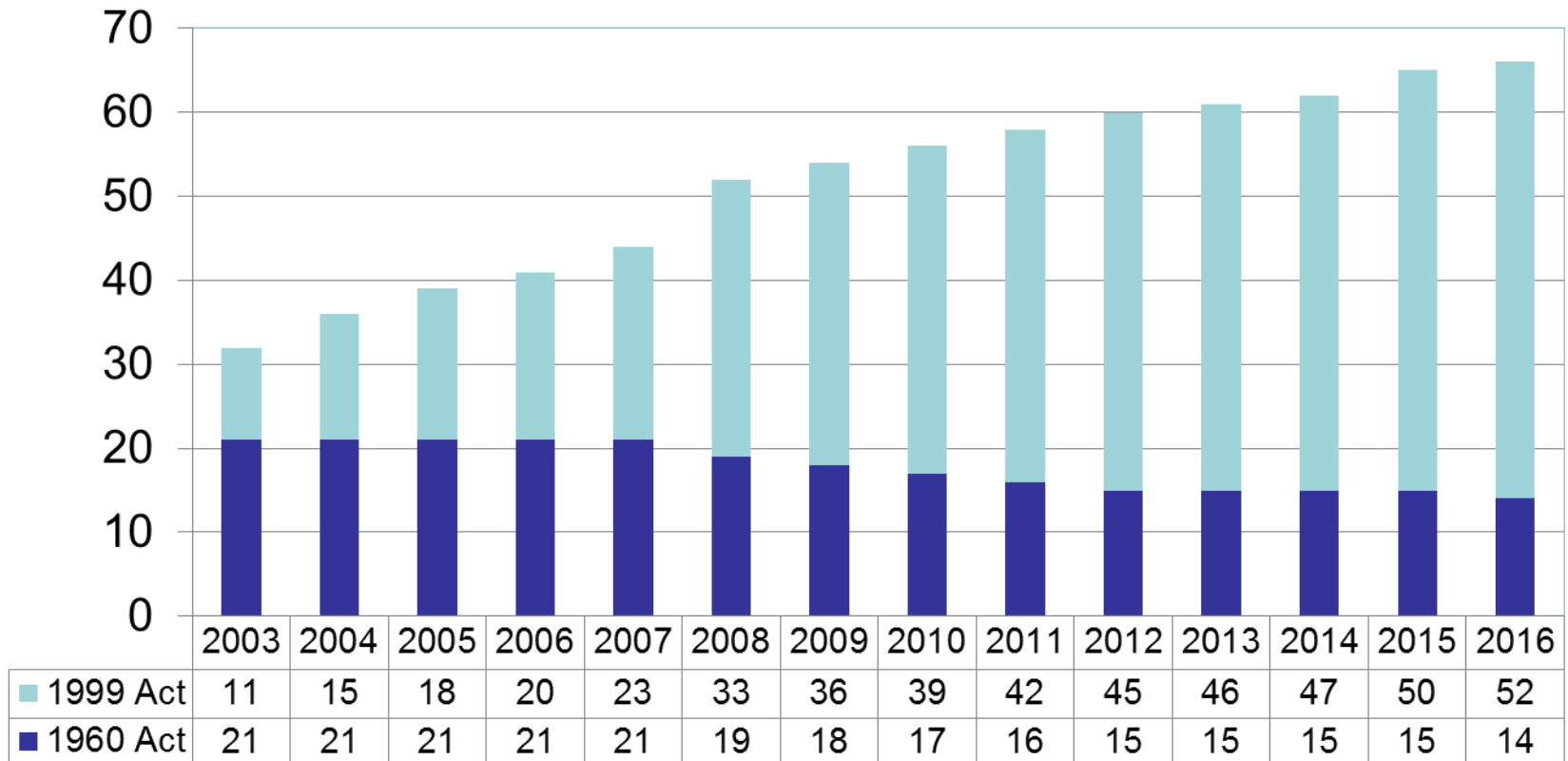

# International Registrations Recorded 2010-2016

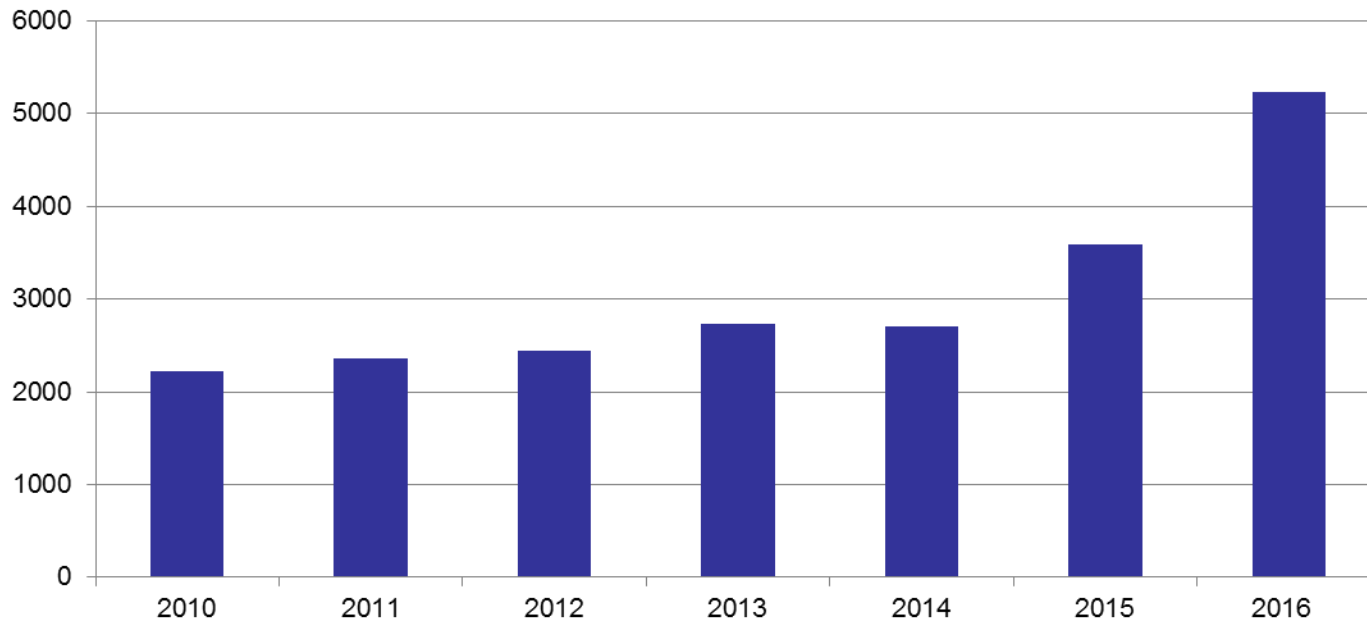

International Registrations Recorded

2216

2363

2440

2734

2703

3581

5233

Growth

11.7%

6.6%

3.3%

12.0%

-1.1%

32.5%

46.1%

# Most designated Contracting Parties in 2017 (until Sept.30) (international registrations)

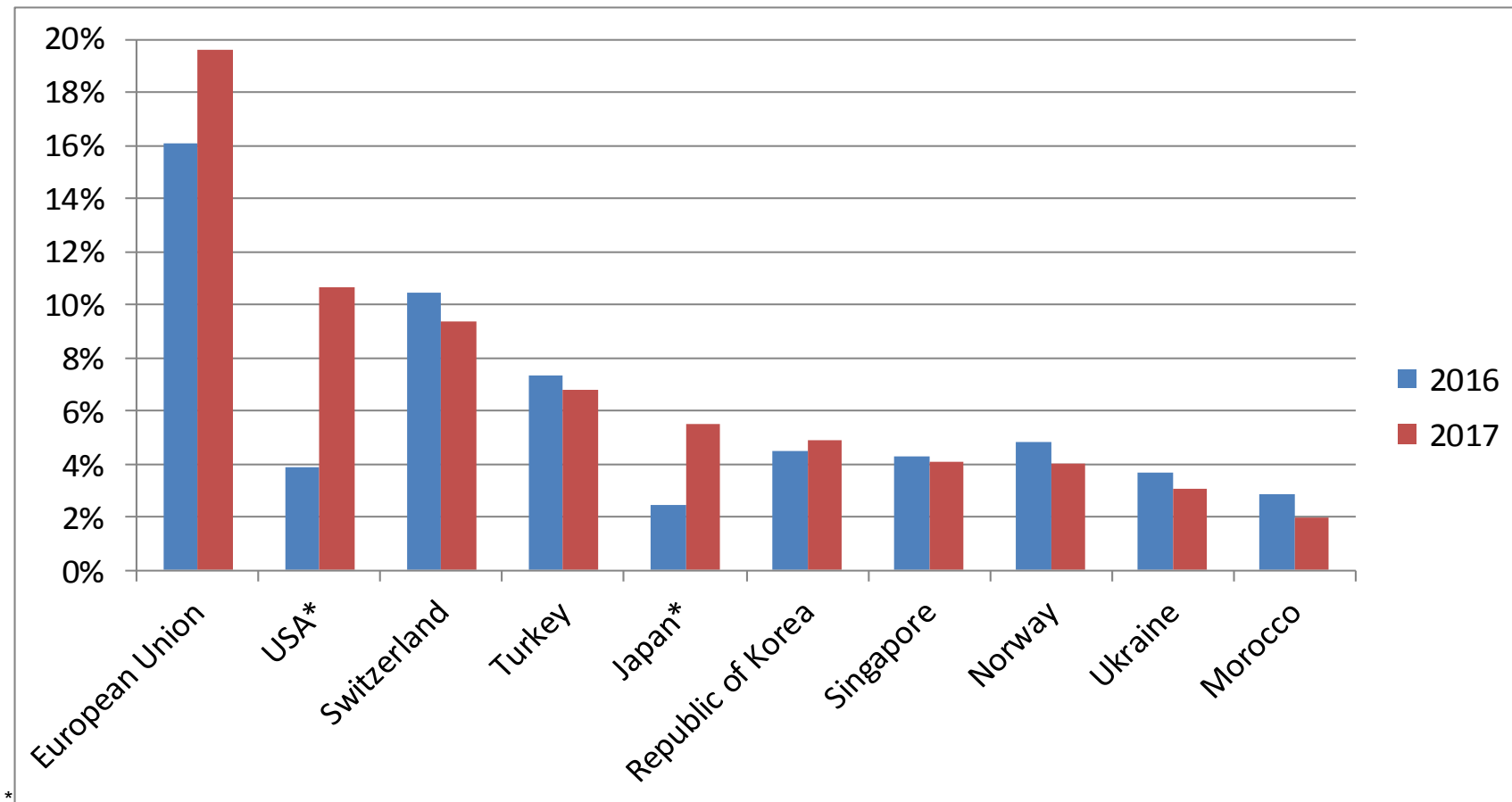

## International Applications - 2016



5,562 international applications were received containing 18,716 designs (max. 100 designs / application)



35.29% growth compared to the respective period in 2015 in the number of applications



13.9% growth compared to the respective period in 2015 in the number of designs

# International Registrations - 2016



5,233 international registrations were inscribed containing 17,601 designs



46.1% growth compared to the respective period in 2015 in the number of registrations



21.5% growth compared to the respective period in 2015 in the number of designs

# 2016 - Five Most Popular Classes in International Registrations



**Class 14**

**Recording, communication or information retrieval equipment**

**551 registrations (14.1%)**



**Class 12**

**Means of transport or hoisting**

**339 registrations (8.7%)**



**Class 15**

**Machines, not elsewhere specified**

**324 registrations (8.3%)**



**Class 10**

**Clocks and watches and other measuring instruments, checking and signaling instruments**

**266 registrations (6.8%)**



**Class 6**

**Furnishing**

**249 registrations (6.3%)**



# Latest Developments and Upcoming Features

# Latest Developments



Regularization of international applications online  
(since March 2016)



Guidance on reproductions\*



New Hague Express Database since January 2015



Global Design Database launched in 2015



Improvement of E-filing interface



Developments in the legal framework



# Hague Express Database

## Hague Express

The Hague Express Database, updated weekly, includes bibliographical data and, as far as international registrations governed exclusively or partly by the 1999 and/or by the 1960 Act(s) of the Hague Agreement are concerned, reproductions of industrial designs relating to international registrations that have been recorded in the International Register and published in the International Designs Bulletin as of issue No. 1/1999. International registrations that have lapsed are not removed from the database.

### SEARCH BY

Design Names Numbers Dates Country

Indication of Products =

Locarno =

Description =

search ↗

#### CURRENT SEARCH

PROD:watch ✕

### FILTER BY

Designation Locarno Class Reg. Date \* Contracting Party \*

CH	1,535	MC	1,131	TN	991	MA	963	LI	960
FR	894	DE	890	IT	889	EG	887	BX	851
BE	851	NL	851	LU	851	ES	813	ME	684
MK	683	GR	666	MD	642	MN	634	SG	611
TR	594	UA	591	ID	586	EM	583	KP	556
RS	523	VA	489	SI	462	CW	409	BQ	408
SX	406	GE	380	RO	378	KG	376	BZ	364



Display: List Sort: Count - desc

filter ▼

1 - 10 / 1,627

edit columns ↔

10 per page 1 / 163

Reg. No	Holder	Reg. Date	Locarno Cl	Ind. Prod.	Des.	Designs	Image
DM/046674	HYSEK JÖRG	1999-02-03	03-01	Etui pour montre	AN,EG,ES,ID,MA,TN,V	1	
DM/082429	CARTIER CREATION STUDIO SA	2013-12-13	10-02	1. Watch; 2. Watch case; 3. Watch dial; 4. Watch; 5. Watch bracelet; 6. Watch dial; 7. Watch dial	CH,EM,SG,TR	8	
DM/083367	FRANCK MULLER WATCHLAND SA	2014-04-09	10-02	1. Montre-bracelet	EM,MC,SG	1	
DM/065362	SWATCH AG (SWATCH SA) (SWATCH LTD.)	2004-05-12	10-02	1. Montre-bracelet	BQ,CW,EG,ID,SX,TN,I	1	
DM/073485	BÉDAT & CO SA	2010-03-26	10-02	Watch	BX,KP,CH,EM,LI,OA,S	1	
DM/073351	HUBLOT SA, GENÈVE	2010-03-18	10-02	Watch	CH,EM,SG	1	
DM/073317	OMEGA SA (OMEGA AG) (OMEGA LTD.)	2010-02-12	10-02	Watch	BZ,MA,MC,ME,AL,AM,I	1	
DM/072570	ALEXIS BARTHELAY (SOCIÉTÉ ANONYME)	2009-10-20	10-02	Watch	MA,CH,EG,EM,OM,SG	1	

# New Features of the E-Filing Portfolio Manager



Send corrections to irregularities or defects



Receive and download notifications from the IB relating to international applications



Retrieve in real-time current status of IA

Welcome ASTON88 →

**Portfolio Status**

Number of application(s) sent: **46**  
Number of application(s) unsubmitted: **10**



**E-Filing Manager Menu**

- E-Filing Application
- E-Filing Communications (0 unread)
- E-Filing Tutorial

File an international application | **Sent application(s)** | Unsent application(s)

**Application(s) sent to the International Bureau**













(1 of 5)    <<    1    2    3    4    5    >>

	WIPO reference ⌵	Filing date ⌵	Applicant(s) ⌵	Locarno Class ⌵	Designation(s) ⌵	Status ⌵	A.R.
1	WIPO4059	05/08/2016	Jack Smith	6	JP, KR, RS, SG, SN, SY, US	Examination	
2	WIPO4151	05/08/2016	New Designs SA	2	DE, ES, GH, JP, US	Registered	
3	WIPO4146	27/07/2016	Helen Williams	3	JP, KR, TR, UA, US	Abandoned	

# E-Filing Portfolio Manager

WIPO reference

39014

-  Applicant(s)
-  Representative Correspondence
-  Designation(s)
-  Design(s)
- Related Design(s)
- Description
-  Creator(s)
-  Priority(ies)
-  Exhibition(s)
-  More Optional Contents
-  Publication
-  Signature
-  Payment/Validat.
- Summary
-  Return to e-filing manager

Information regarding data entry

Please continue on this page if you wish to register a new applicant. Otherwise, click on the next tab on the left.

Information concerning the applicant

**Name and address**

Name \*  Telephone

Address \*  Fax

Zip/Post code  E-mail address

Town \*  Address of website

Country\*

(\*) Compulsory

**Entitlements \*\***

Nationality

Domicile

Real and effective industrial or commercial establishment

Habitual residence



(\*\*) Indicate at least one entitlement

**Applicant's Contracting Party (ACP)**

Applicant's Contracting Party

Save Cancel

Applicant(s) registered

Name	Address	Nat.	Dom.	Estab.	Res.	ACP	Act(s)	Actions
Yves Clozet	34 Ch. des Colombettes 1211 Lausanne Switzerland	BX		EM		EM	60/99	 

# Priority Documents

## Republic of Korea

- Priority documents may be attached to the IA at the time of filing.
- When failed to attach the priority documents to the IA, these documents shall be submitted directly to KIPO through a local agent within three months from the date of publication of the IR.

## Japan

- Original priority documents have to be sent directly to the JPO through a local agent within three months from the date of publication of the IR.

## United States of America

- Original priority documents have to be sent directly to the USPTO at the latest before “the date on which the issue fee is paid”.

# Guidance on Reproductions

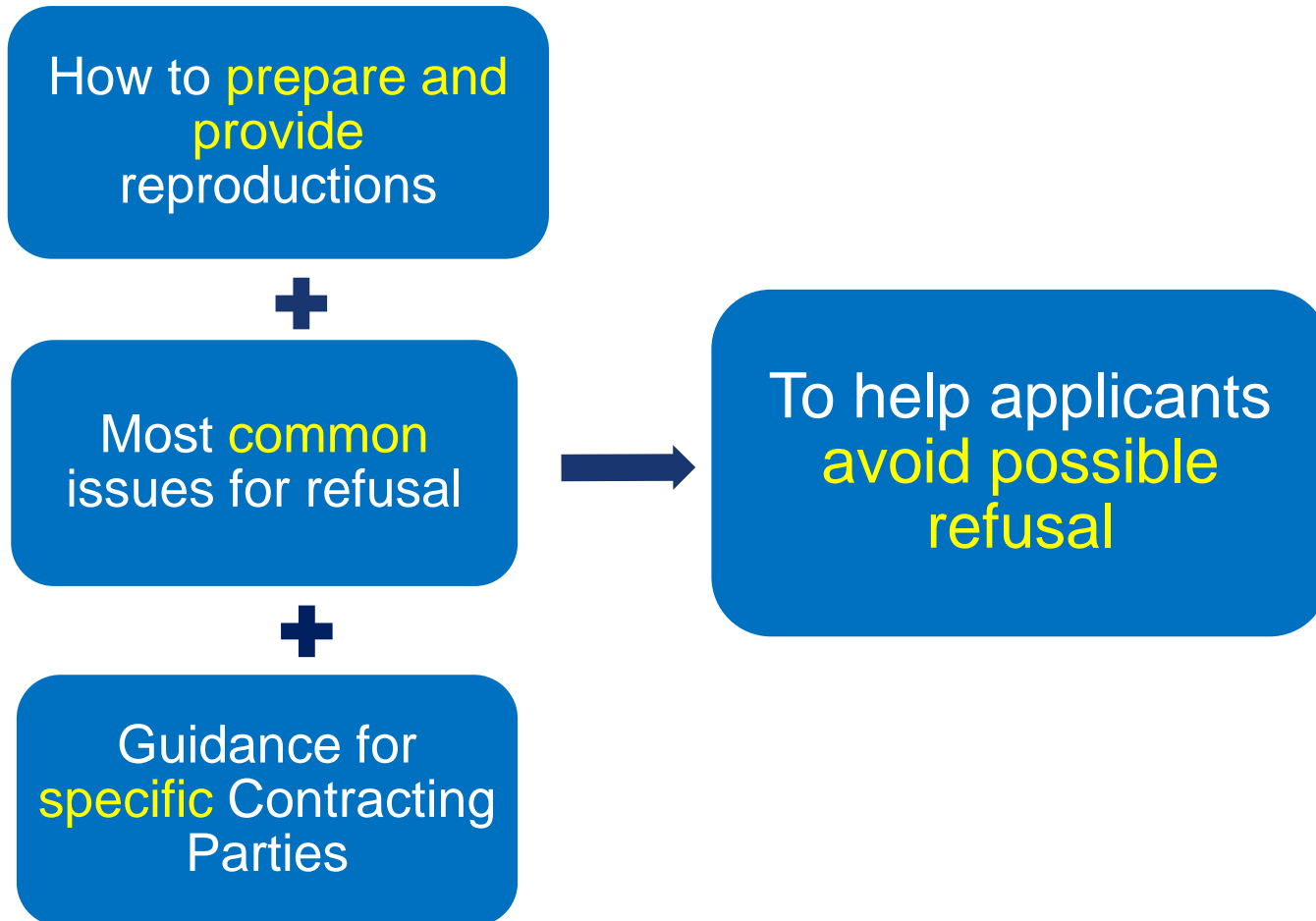

# Reproduction Examples (1)

1.1



1.1) Perspective

1.2



1.2) Perspective

D089713 – Hilti Aktiengesellschaft

1.3

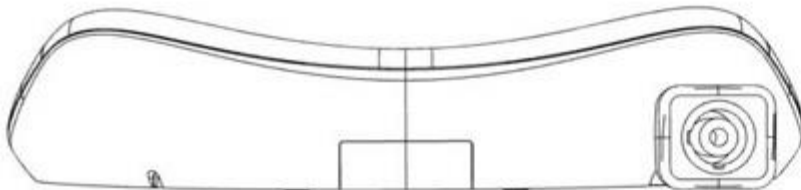

1.3) Back

1.4

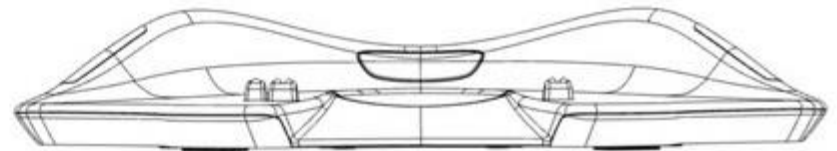

1.4) Front

D087535 – Softbank Robotics

# Reproduction Examples (2)

1.2



1.2) Back

1.3



1.3) Left

1.4



1.4) Right

D089858 – Ninebot (Beijing) Tech

1.1

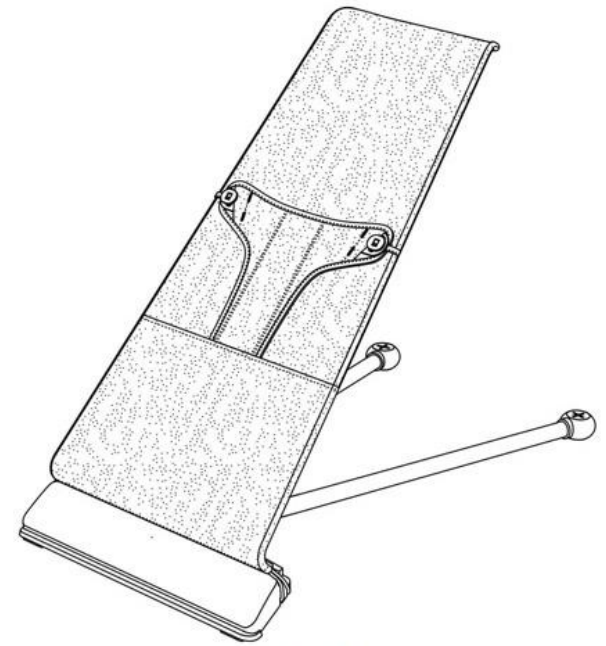

1.1) Perspective

D086974 – Babyjorn AB



**Thank You!**

[www.wipo.int/hague/en](http://www.wipo.int/hague/en)