

 **Practical Guidance to Users Designating
Japan, the Republic of Korea and the
United States of America**

**Seminar on the Hague System for the International
Registration of Industrial Designs**

Sachiko Chiba, Ho Beom Jeon,
Hiroshi Okutomi

**Geneva
November 19, 2015**

Topics Addressed

- Specific issues to the United States of America
- Specific issues to Japan and the Republic of Korea
- Priority documents
- Reproductions and other common issues

Statistics – Refusals: KR, JP, US

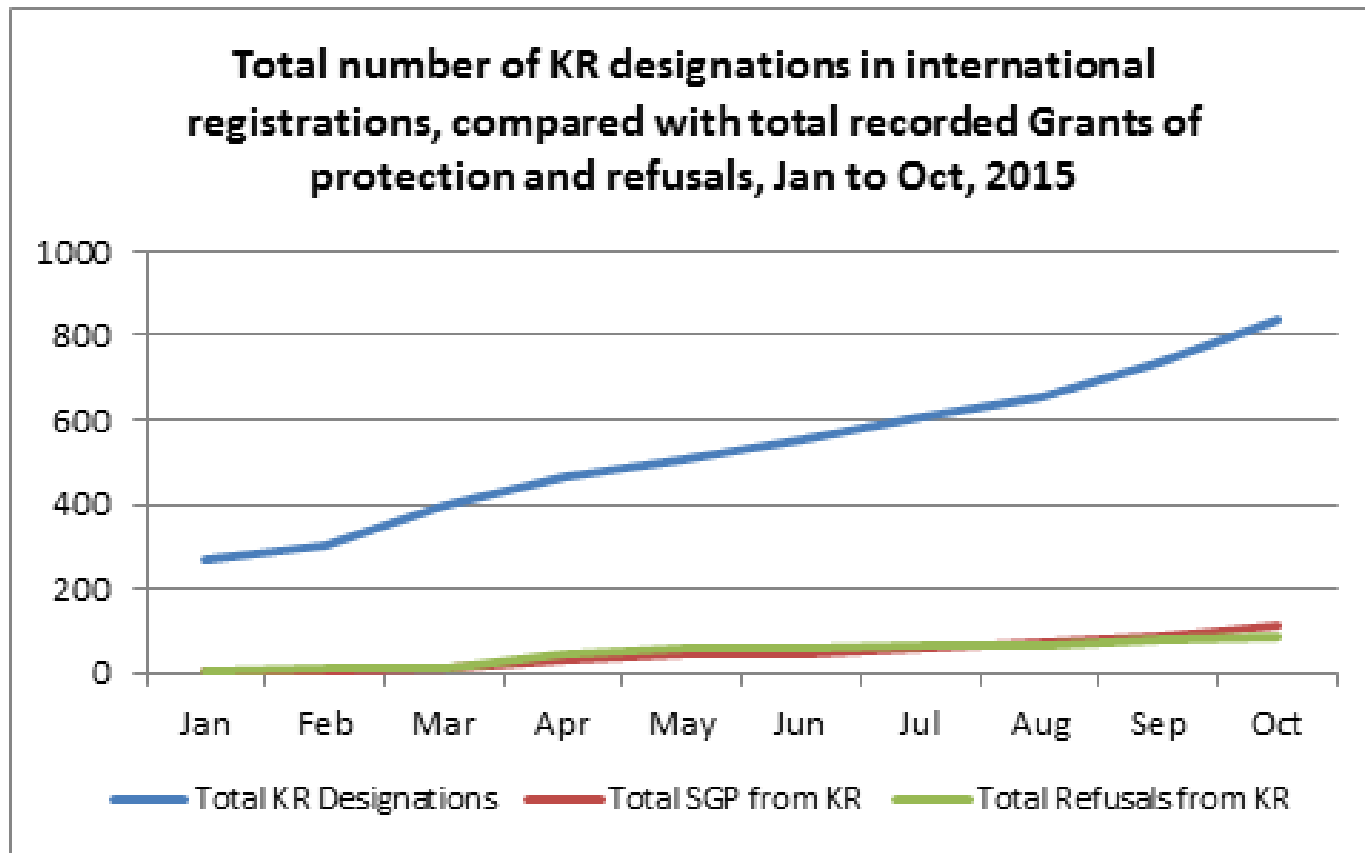

Office	Designations	Recorded refusals	Recorded grants
KIPO	836	88	110
JPO	253	0	0
USPTO	386	1	0

Source: Internal (unofficial) Statistics

■ Specific Issues to the USA

USA: Indirect filing and security clearance

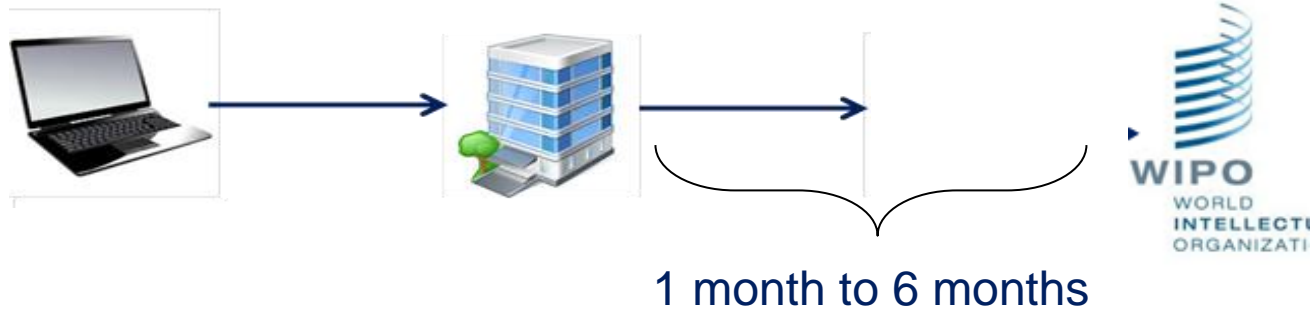

The filing date shall be the date on which the Office received the international application, provided that it is received by the International Bureau within one month from that date and the application is governed exclusively by the 1999 Act (Rule 13(3)).

The USA whose law requires security clearance made a declaration to extend the above period to six months (Rule 13(4))

USA: A single design system

■ Declaration under Article 13(1):

Only one independent and distinct design may be accepted.

- no examination by IB
- possibility of refusal by USPTO based on this condition
- any patentably distinct design should be eliminated.

■ Claim: A single claim

■ Fee (Individual designation fee):

A single fee, although different amounts apply according to the economic status of the applicant

Declaration under Article 13(1): JP, KR and US

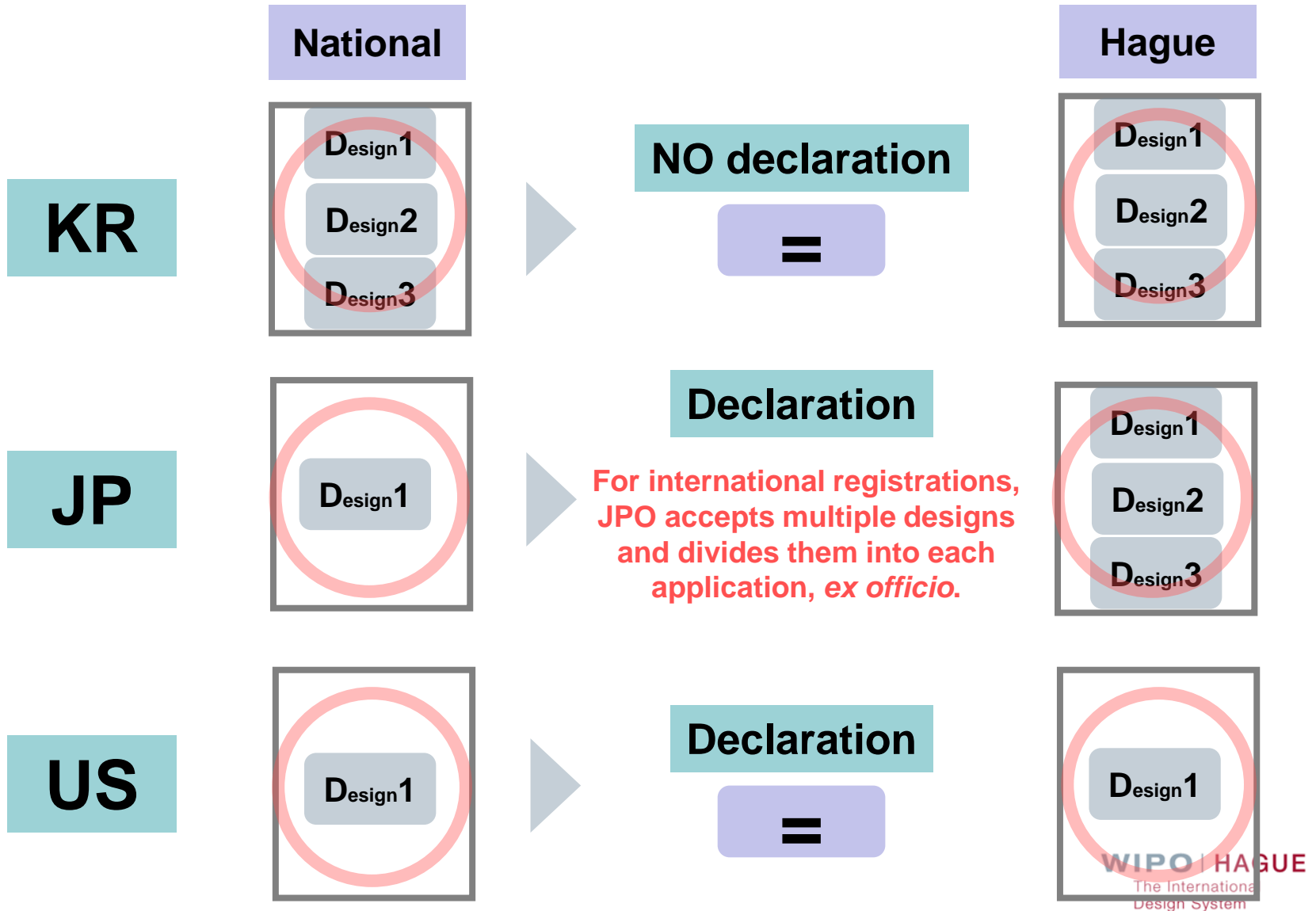

USA: Claim

- Through declaration under Article 5(2)

Date of international registration affected

- A claim must be provided in a specific wording, that is:

The ornamental design for «product indication» as shown and described.

- *Point: provide only one claim in item 12 of DM/1 or «claim» item in E-Filing Interface, even for multiple designs.*

USA: Provisional rights

- After the date of international publication

The holder may send a «cease and desist letter» to an infringer, notifying the design claimed in the published international registration; and

- After the grant of design patent

The holder may sue the infringer for design patent infringement and claim damages dating back to the cease and desist letter.

USA: Individual designation fee

- Article 7(2) for individual designation fee
 - a single fee for a single design
 - but three different amounts
 - for standard, small, or micro entity (with certification)

- Rule 12(3) for designation fee to be paid in two parts
 - first part: at the time of international application
 - second part: upon notice of allowance by USPTO
 - payment for the second part: to IB or USPTO
 - this second part covers the full period of 15 years (no renewal fee)

USA: Payment of the 2nd part of designation fee

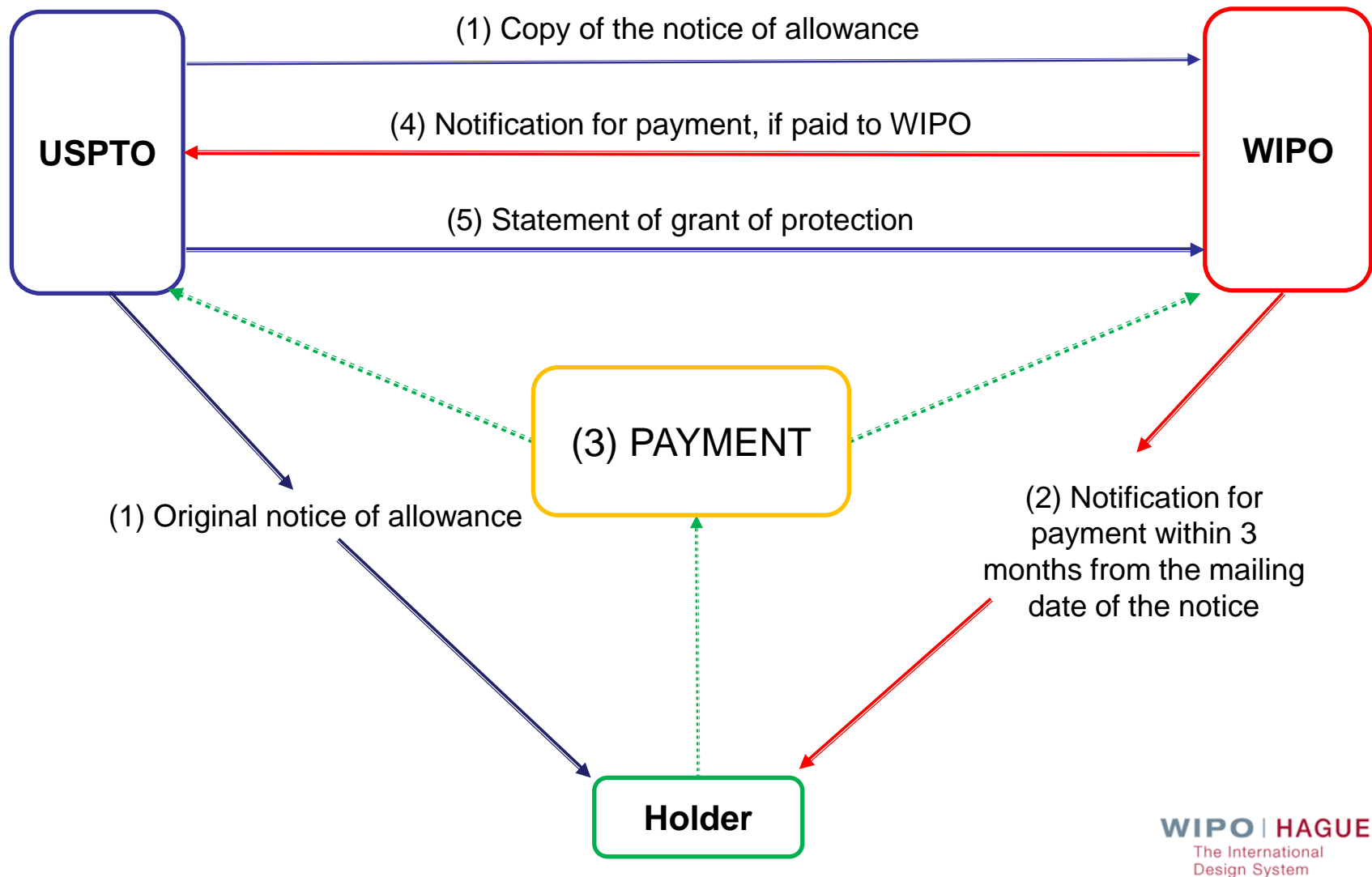

USA: Payment of the 2nd part of designation fee

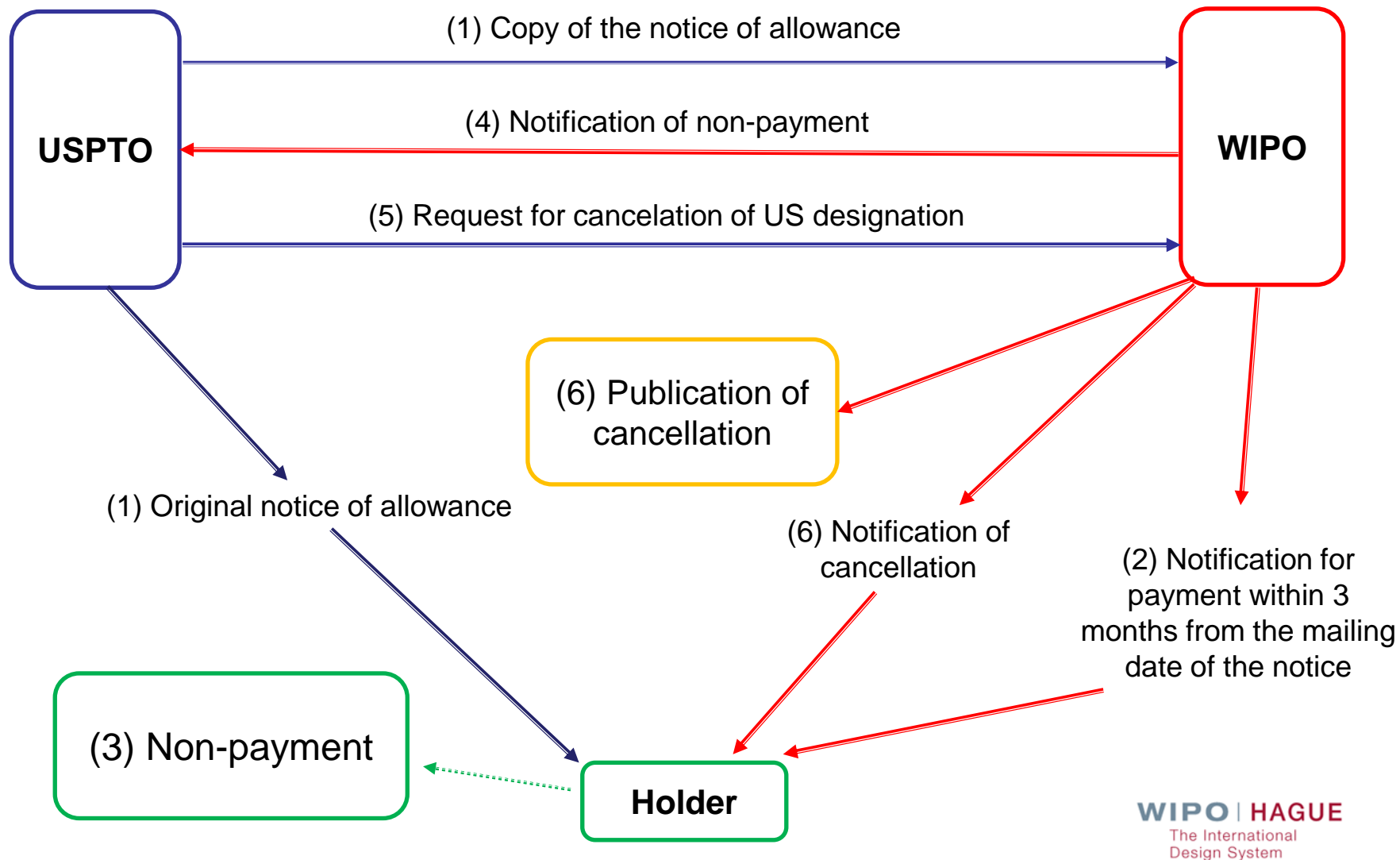

USA: Reduction of the designation fee

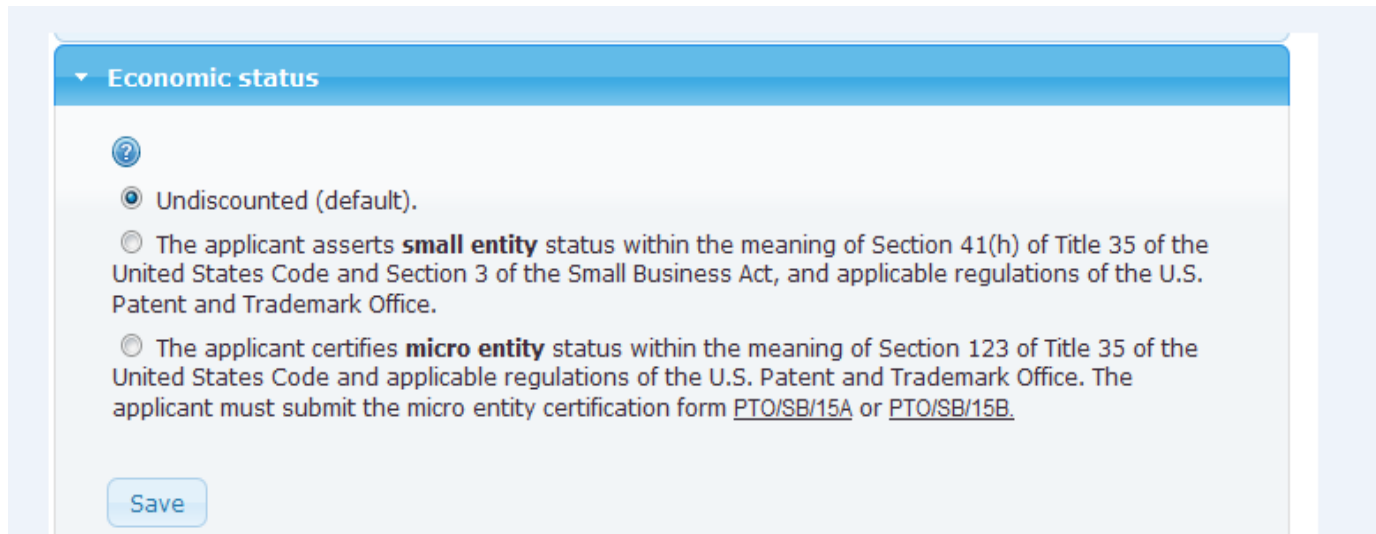

The screenshot shows a web form titled "Economic status" with a dropdown arrow on the left. Below the title is a help icon (question mark in a circle). There are three radio button options:

- Undiscounted (default).
- The applicant asserts **small entity** status within the meaning of Section 41(h) of Title 35 of the United States Code and Section 3 of the Small Business Act, and applicable regulations of the U.S. Patent and Trademark Office.
- The applicant certifies **micro entity** status within the meaning of Section 123 of Title 35 of the United States Code and applicable regulations of the U.S. Patent and Trademark Office. The applicant must submit the micro entity certification form [PTO/SB/15A](#) or [PTO/SB/15B](#).

At the bottom left of the form is a "Save" button.

- Default: 733 CHF (1st) + 540CHF (2nd)
 - Small entity: 367 CHF (1st) + 270 CHF (2nd)
 - Micro entity: 183 CHF (1st) + 135 CHF (2nd)
- To claim a micro entity status, certification required by a hard copy (with Annex IV) or PDF (E-Filing))
USPTO Certification forms: (PTO/SB/15A or PTO/SB/15B),
available at: http://www.uspto.gov/forms/aia_forms.jsp.

USA: Information on eligibility for protection

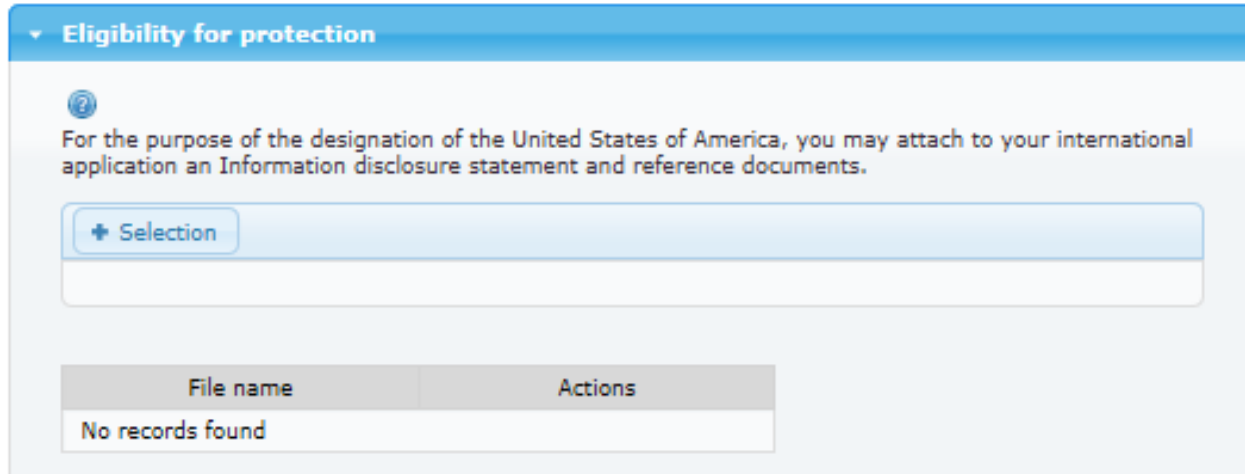

Eligibility for protection

For the purpose of the designation of the United States of America, you may attach to your international application an Information disclosure statement and reference documents.

+ Selection

File name	Actions
No records found	

■ “Information Disclosure Statement”

- May be submitted to IB (at the time of application only, by a hard copy (with Annex III) or PDF (E-Filing)),
- Or otherwise, must be submitted to USPTO (later)

Form (USPTO): http://www.uspto.gov/forms/aia_forms.jsp.

Information (USPTO): <http://www.uspto.gov/web/offices/pac/mpep/s609.html>.

USA: Oath or Declaration of the creator

- **“Declaration of inventorship”**

Required from each of the creators

- **Standard WIPO form (DM/1/I)**

http://www.wipo.int/export/sites/www/hague/en/forms/docs/form_dm_1_annex_1.pdf

(in English, French and Spanish)

- **Electronic WIPO form on E-Filing Interface**

- **Standard USPTO form**

<http://www.uspto.gov/sites/default/files/forms/aia0001.pdf>

(in 11 languages)

USA: Oath or Declaration of the creator

- “Substitute Statement”

May be used where it is not possible to obtain the signature of the inventor.

- Standard WIPO form (DM/1/I)

http://www.wipo.int/export/sites/www/hague/en/forms/docs/form_dm_1_annex_I.pdf (in English, French and Spanish)

- Electronic WIPO form on E-Filing Interface

- Standard USPTO form

<http://www.uspto.gov/sites/default/files/forms/aia0002.pdf>
(in 11 languages)

■ Specific Issues to Japan and the Republic of Korea

Grounds of refusals by KIPO

(from July 1, 2014 to September 30, 2015)

Source: Internal (unofficial) statistics

Number of refusals by KIPO

312 designs
(87 international registrations)

Main grounds of refusals

1. Insufficient disclosure
163 designs
2. No indication of a creator
160 designs
3. Similar designs on the same date by the same holder
(No indication of the related design)
98 designs
4. Broad indication of a product
22 designs

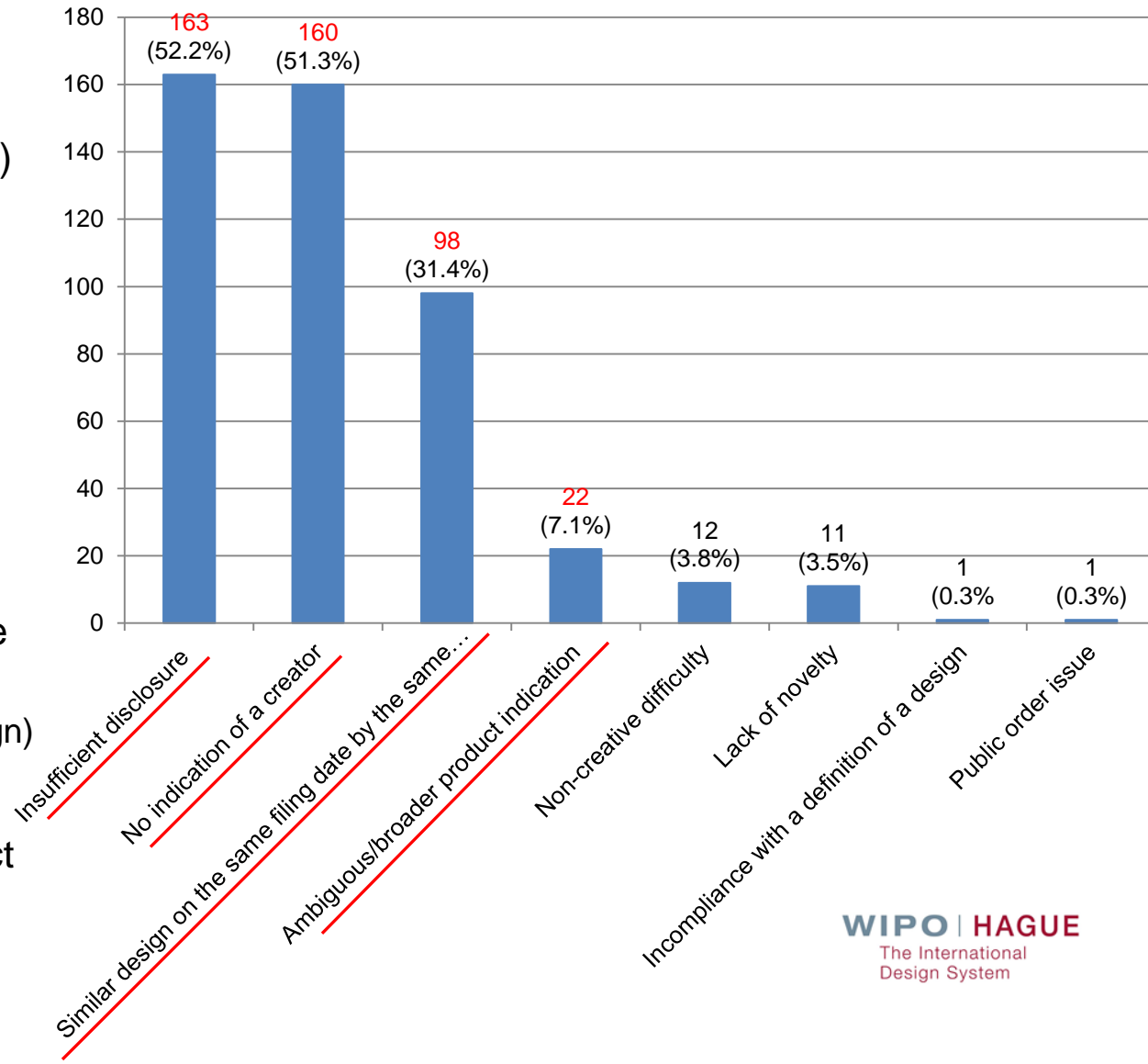

Grounds of refusals by KIPO

(from July 1, 2014 to September 30, 2015)

Insufficient disclosure: 163 designs (45 international registrations)

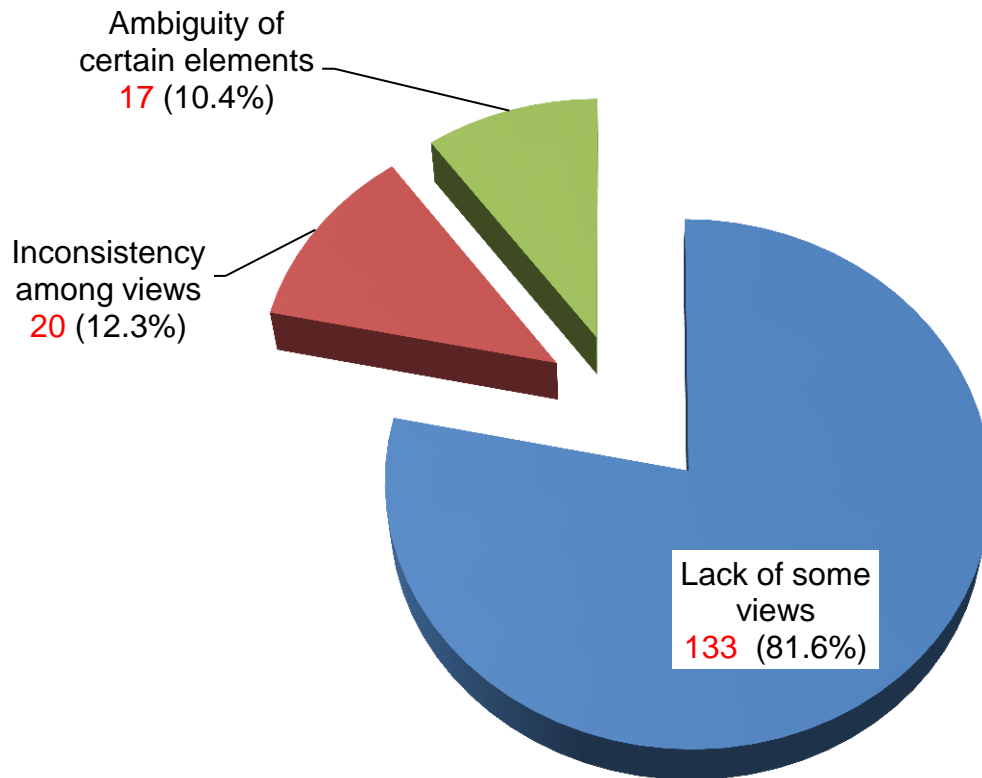

Source: Internal (unofficial) statistics

Reasons of insufficient disclosure

1. Lack of some views: 133 designs

- Lack of some of six orthographic views
- Lack of certain view for a set of an article showing the design comprehensively

2. Inconsistency among views: 20 designs



- Color difference among the views
- A certain part shown in one view is not shown in other views
- A certain part shown by solid lines is shown by broken lines in other views

3. Ambiguity of certain elements in the representation: 17 designs

- The broken lines (disclaimed part or stitch)
- The shading (disclaimed part or pattern)

Grounds of refusals by KIPO

(from July 1, 2014 to September 30, 2015)

Ambiguous/broad product indication	
	
Lamp	Lamp for table
Lighting device	Lamps(Standard-)/Lamps(non portable), etc.
Footwear	Men's shoes/high-heeled shoes/ slipper/ Sandals, etc.
Single or multicomponent discharge device	Device for silicone discharge/Nail discharge device, etc.

What is related design?

DM/086182

1.1



2.1

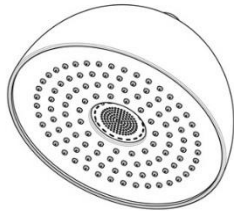

3.1

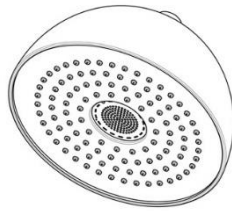

4.1

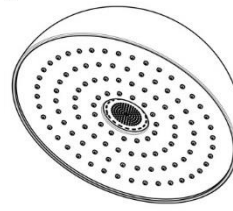

5.1



6.2

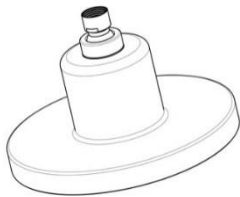

7.2

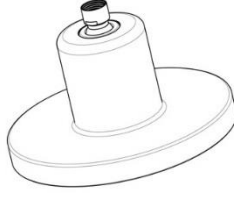

8.2

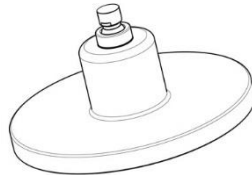

9.1



10.1



11.1

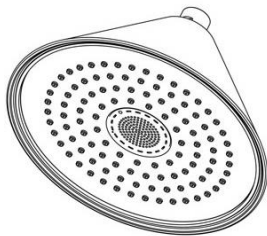

12.1

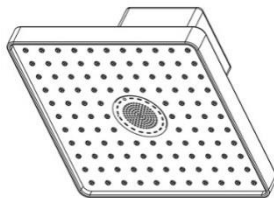

13.1

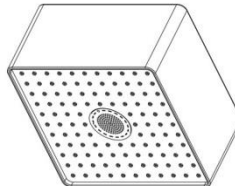

14.1

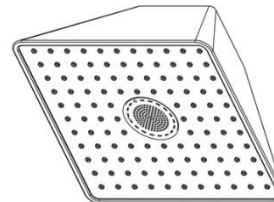

What is related design?

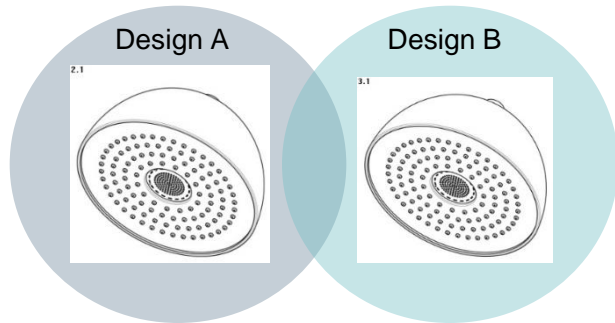

- Similar
- Filed by the same applicant
- Filed in appropriate duration

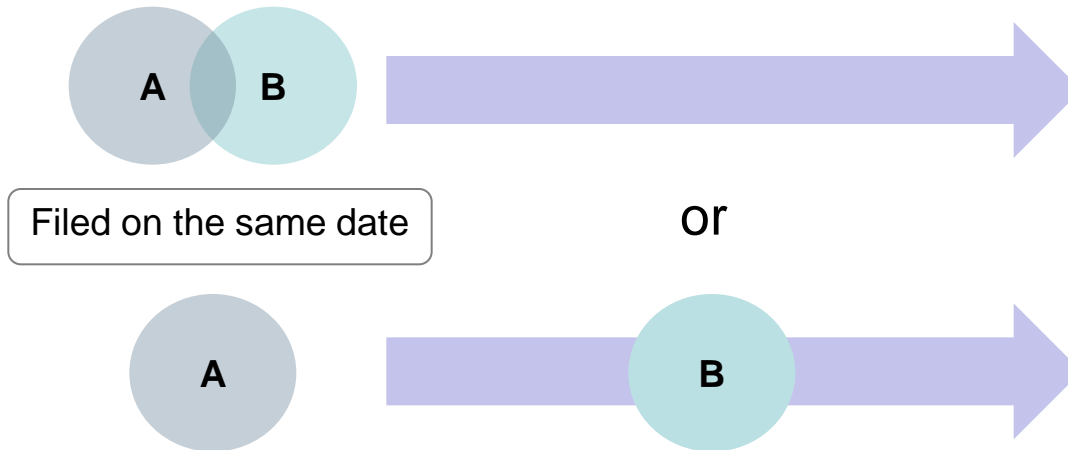

Principal design

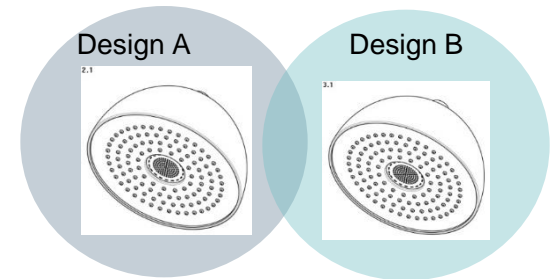

Related design

Design B may be registered as a related design of Design A

KR: filed within 1 year from the filing date of Design A

JP: after the filing date and before the date of publication for design registration of Design A in JP

Exception to lack of novelty: KR, JP

Disclosure of Design A

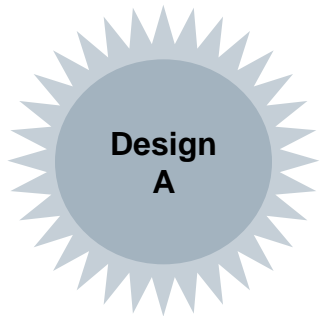

In an exhibition, published materials such as a magazine, catalog, or through the internet media, etc.

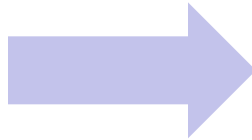

Filing of an IA

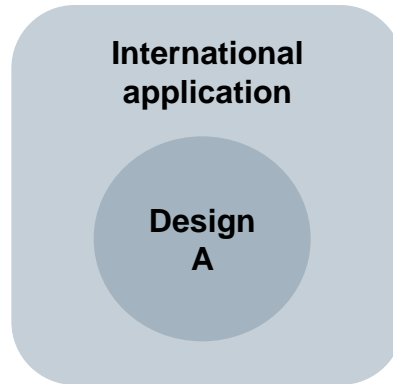

- Filing within 6 months from the date of disclosure
- With declaration concerning exception to lack of novelty

Examination by JPO/KIPO

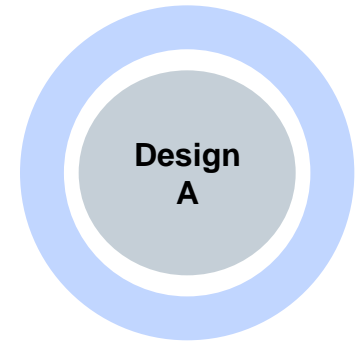

Disclosure of Design A does not become a reason for lack of novelty

Exception to lack of novelty: KR, JP

Supporting document

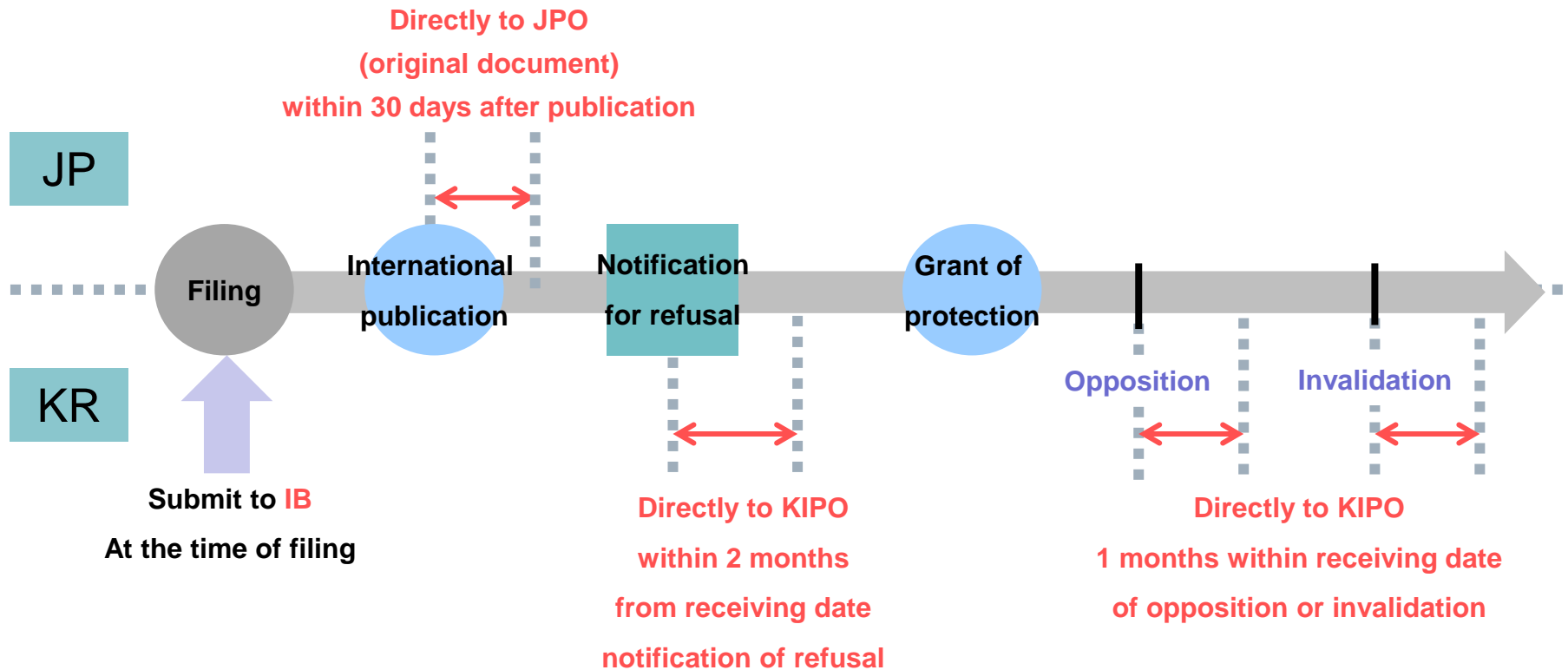

(Only in KR) After filing, directly to KIPO

- Upon submitting written opinion against notification of refusal
- Upon submitting written refutation against opposition or invalidation

Refusal period for KR

- International classification 2, 5, or 19 → **6 months** from the date of publication
* *Class 2 (clothing, footwear), 5 (textile, sheet materials), 19 (stationary)*
- Others except for International classification 2, 5, or 19 → **12 months** from the date of publication

< Substantive examination > (Except for class 2, 5, and 19)

- Industrial Applicability
 - Definition of design
 - Insufficient disclosure
- Novelty
- Creativity
- Not to be any of the unregistrable Design Categories (ex. public order)

< Partially substantive examination > (Class 2, 5, and 19)

- Industrial Applicability
 - Definition of design
 - Insufficient disclosure
- Novelty (X)
- Creativity (X)
- Not to be any of the unregistrable Design Categories(ex. public order)

■ Priority Documents

Priority documents for JP

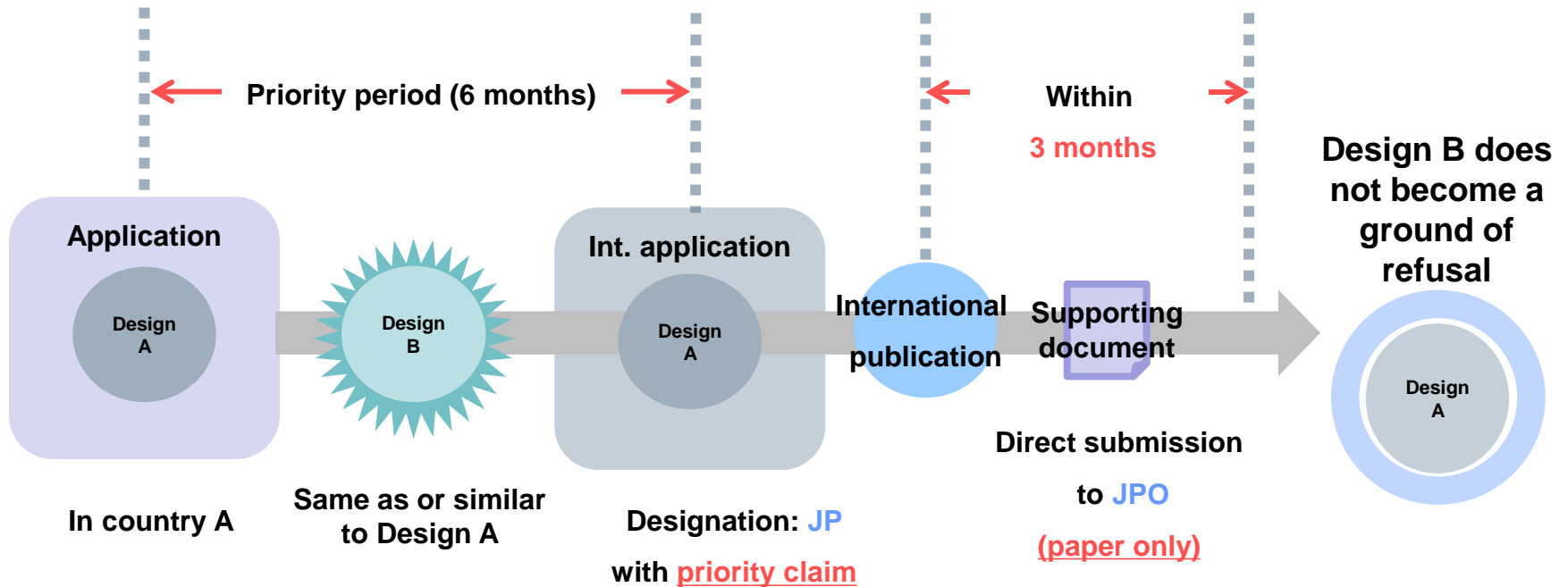

Original priority documents must be submitted directly to the JPO within 3 months from the date of publication of the international registration.

Priority documents for KR

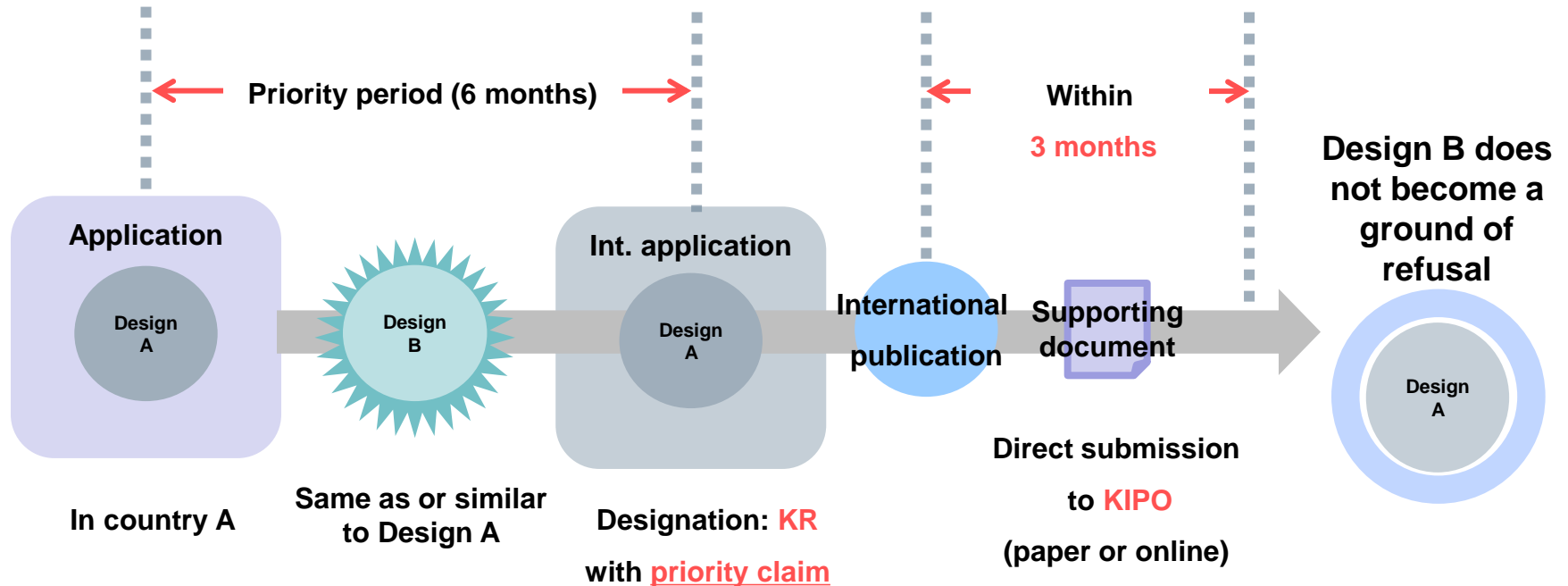

< **Interim measure agreed with KIPO** >

- Priority documents can be attached to international application".
- by using Section for declaration claiming the exception to lack of novelty in E-filing interface, under tab "More optional contents or by using Annex II

Priority documents for US

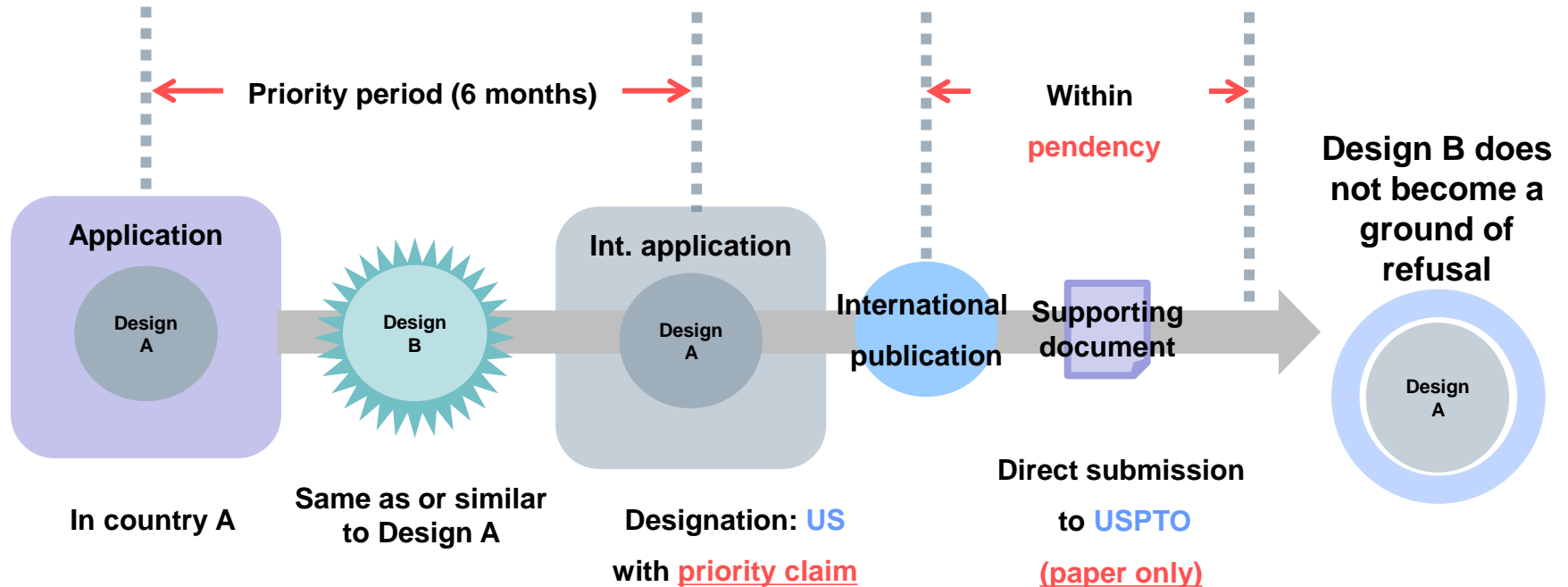

Original priority documents must be submitted directly to the USPTO, at the latest before "the date the issue fee is paid" (according to Title 37 – Code of Federal Regulations Patents, Trademarks, and Copyrights (37 CFR) §1.55, paragraphs (g)(1) and (m)).

■ Reproductions and Other Common Issues

Definition of design; Reproductions: Refusal grounds

- Formal grounds: certain types of «views» required through a declaration under Rule 9(3)(a)
- Substantive grounds: definition of an industrial design in accordance with Article 12(1) under the 1999 Act
 - Type of design not protected (*ex. “logo”*)
 - Disclosure insufficient to figure out the design, justified by Rule 9(4)

Specific views: Declaration under Rule 9(3)(a)

International Bureau

No requirement as to the types of views. A single reproduction is enough.

One perspective view

Front view + top view + right side view

Front view + one perspective view

etc.

The law of the CP

If the law provides for certain types of views that must be submitted, **the CP may specify, in the declaration, the views required and the circumstances in which they are required.**

Six orthographic views

(Front view + Top view + Right side view + Left side view + Rear view + Bottom view)

Two perspective views showing a whole appearance of the product

etc.



Refusal ground; insufficient disclosure (Rule 9(4))

- A CP **may not issue a refusal** on the ground that requirements relating to the form of the reproduction that are additional to, or different from, those specified in the declaration under Rule 9(3)(a) have not been satisfied.
- However, it **may issue a refusal, on an individual case basis**, on the ground that the reproductions contained in the international registration do not sufficiently disclose the industrial design.

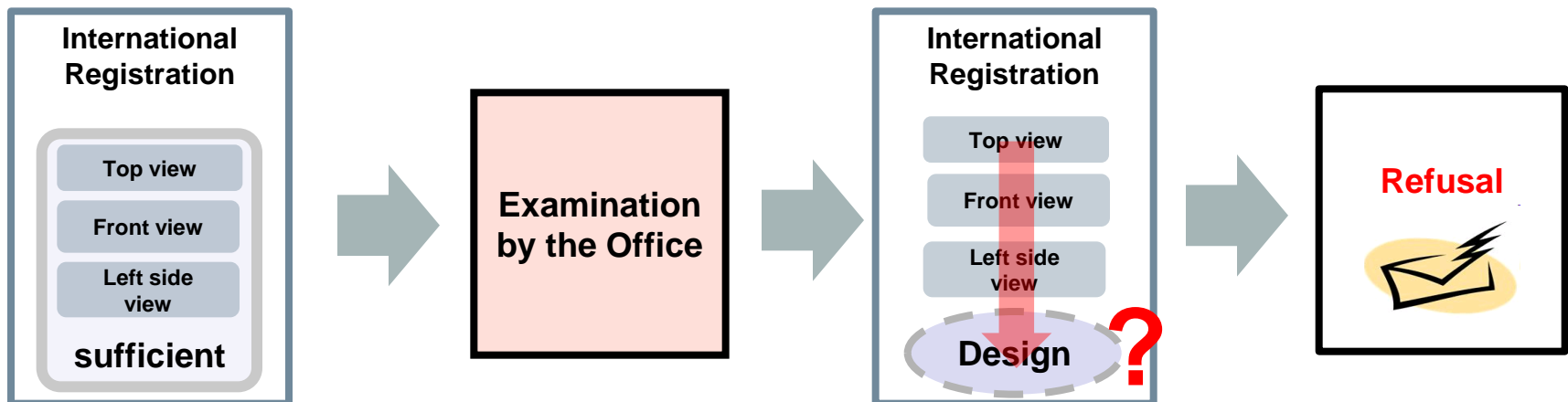

Declaration under Rule 9(3) by JP

■ Six views

front view, back view, top view, bottom view, left view and right view by the orthographic projection, are required

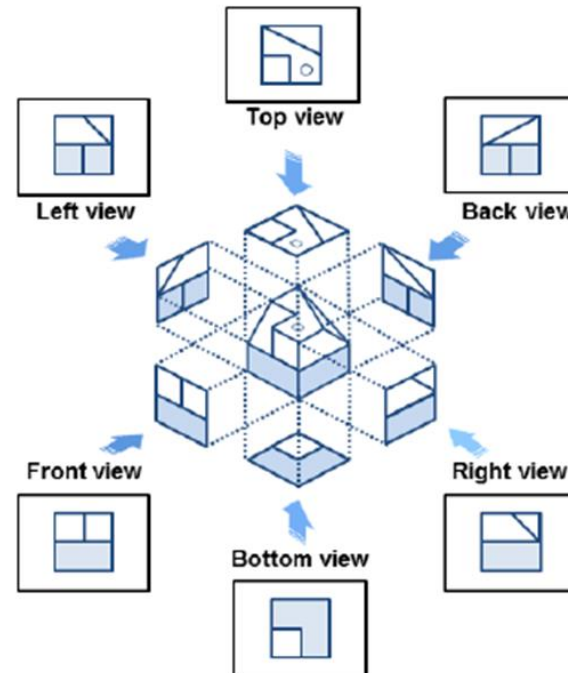

Six views created by the orthographic projection method

Declaration under Rule 9(3) by KR

■ A design of a set of articles

one view of the coordinated whole and/or corresponding views of each of its components

KR 30-0728275 (Set of table with chair for outdoor use)



< Perspective A >
(table + chair)

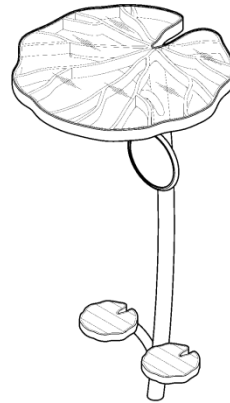

< Perspective B >
(table)



< Perspective C >
(chair)

- Six views with perspective views were included for A, B, and C, respectively)

Declaration under Rule 9(3) by KR

■ Typefaces

views of the given characters, a sample sentence and typical characters

KR 30-0576060 (English typeface)

A B C D E F G
H I J K L M N
O P Q R S T U
V W X Y Z
a b c d e f g h i j
k l m n o p q r
s t u v w x y z

(52 given characters)

The quick
brown fox
jumped
over the
lazy dog

The quick brown fox jumped over
the lazy dog

(sample sentence as
with above)

H a
R e
S g

(typical characters as
with above)

Definition of the industrial design

■ KR: ...the shape, pattern, or color, or a combination of these of an article ...(including part of an article...and font..), which produces an aesthetic impression in the sense of sight

Article 2, Korean Design Protection Act

■ JP: ...the shape, patterns or colors, or any combination thereof, of an article (including a part of an article...), which creates an aesthetic impression through the eye

Article 2 (1) , Japanese Design Act

■ US: ...new, original, and ornamental design for an article of manufacture may obtain a patent therefor, subject to the conditions and requirements of this title.

35 U.S.C. 171 (Patents for designs)



- Movable property which can be independently transacted
- In relation to the appearance of a product



- immovable property, such as real estate, etc.
- Class 32 (graphic symbols, logos, surface patterns, get-up, etc.

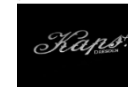

2.2



Reproductions - three dimensional designs

JP: six views (front, back, top, bottom, left, right) are mandatory

KR, US: six views are recommended, not mandatory

DM/086182

Top

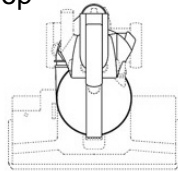

Left

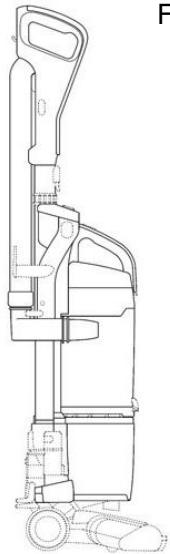

Front

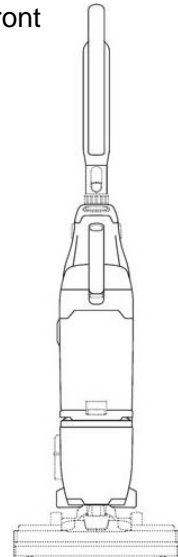

Right

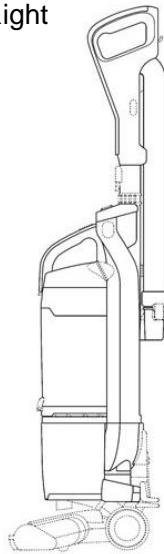

Back

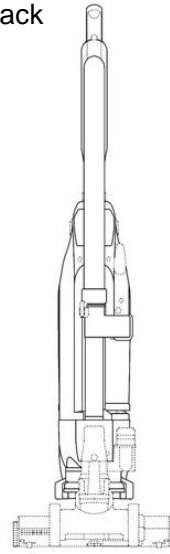

Perspective



- Cross-sectional
- Exploded
- Enlarged

etc.

Bottom

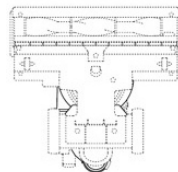

Reproductions – additional view(s)

Perspective

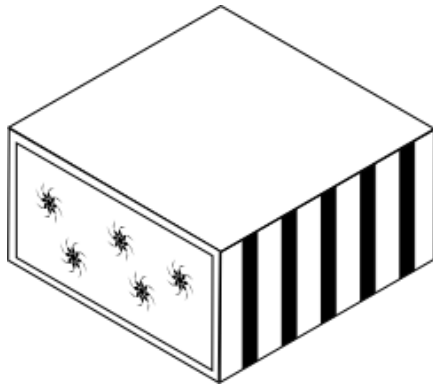

Exploded

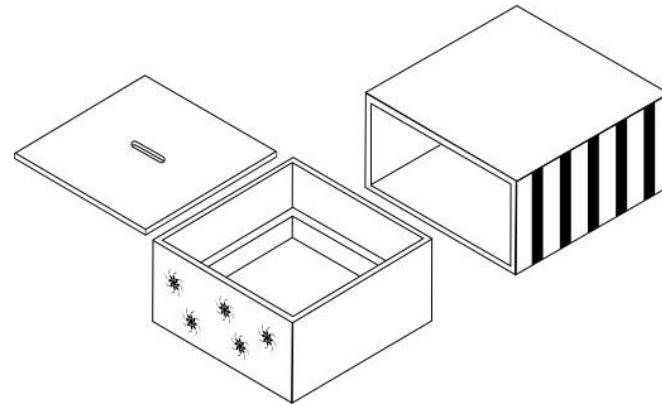

Cross-sectional



Enlarged

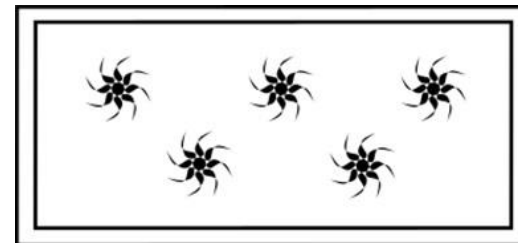

Reproductions – shading and description

Shading can be shown on the reproductions, but should be explained in the description.

DM/086182

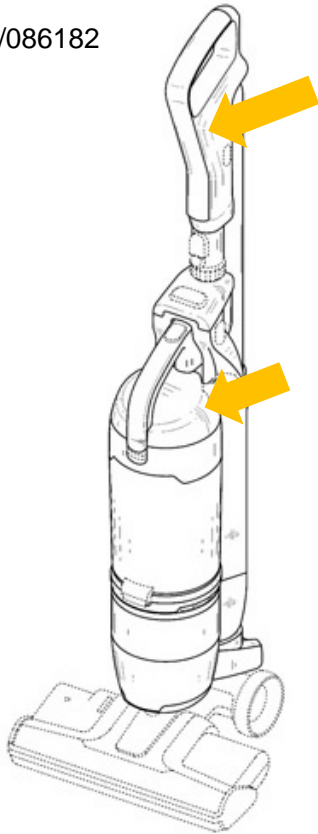

DM/086448

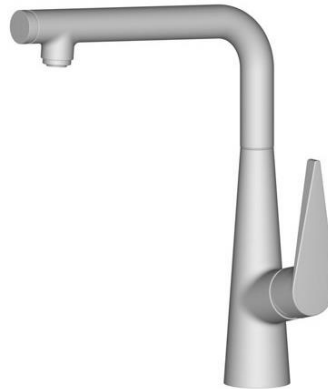

«Description for the above purpose»

JP: required

KR: recommended

US: may not be necessary

Description:

The shading shown on the all reproductions is for specifying its shape and illustrative purposes only

Description:

The thin lines which are shown on the perspective view are shading for specifying its shape and illustrative purposes only

Reproductions - partial designs

DM/086182

Top

2.6

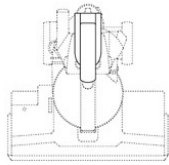

Left

2.4

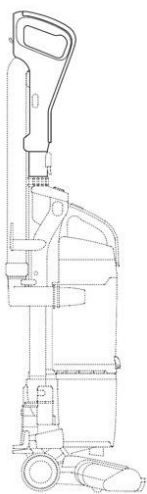

Front

2.2

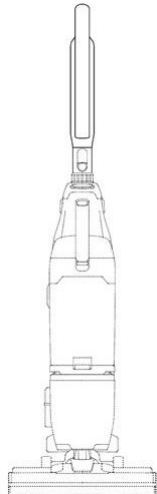

Right

2.5

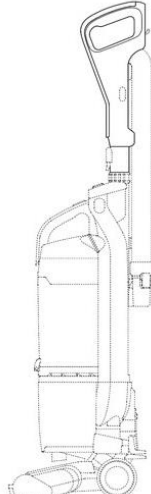

Back

2.3

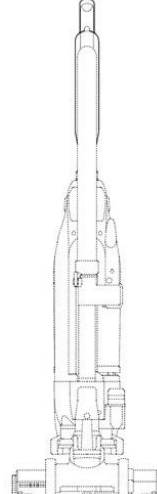

Bottom

2.7

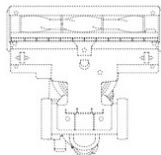

All appearance of a product should be shown in reproductions, even if it is a partial design

Reproductions:

Show disclaimed part(s) in dotted or broken lines or coloring



Descriptions:

The parts which are shown in the dotted lines form no part of the claimed design

JP: required

KR: recommended

US: may not be necessary

Reproductions - two dimensional designs

JP, KR: front view + back view (or description)

Handkerchief

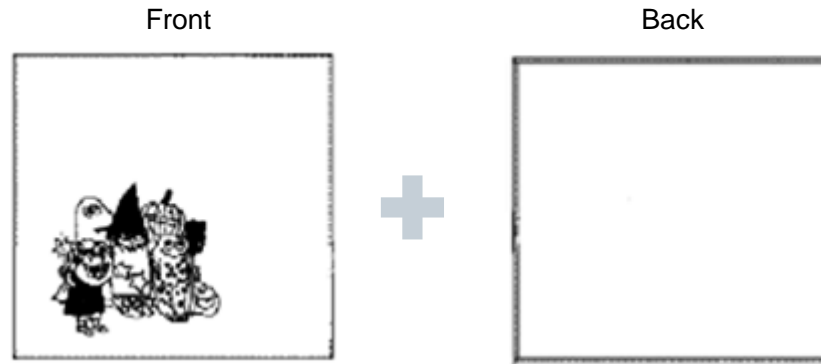

Description:

“back view has same pattern”

or

“back view has no pattern”

or

cf) KIPO considers that back view has no pattern if front view is only submitted (Oct. 1, 2015)

*Product(s) which has an overlapping part

Will be considered as three-dimensional design

(six views needed)

Ex) Envelop



Illustration from “Guide for the way to make documents and drawings for design applications”, Japan Patent Office

1 design or 2 designs?

If one of the reproductions are black and white drawings and the others are in color, it could be considered as 2 different designs.

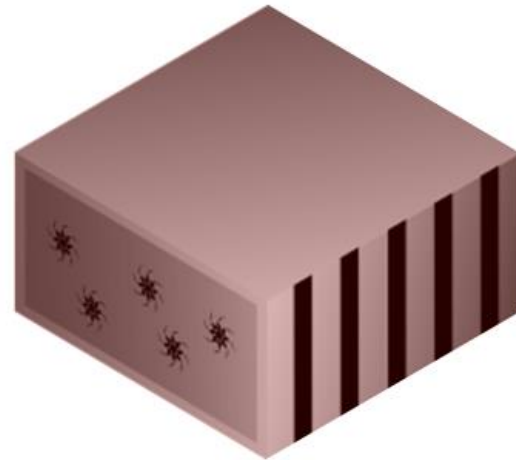
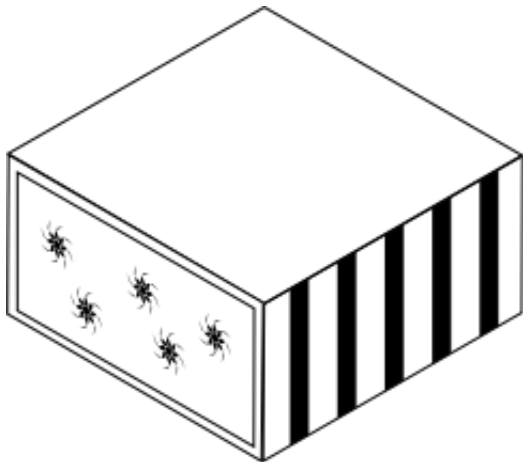

Thank You
www.wipo.int/hague/en