



WIPO | HAGUE

The International
Design System



From Filing to Expiring

Seminar on the Hague System or the
International Registration of Industrial Designs:
The Expansion Continues

Kateryna Gabriele
Operations Service, The Hague Registry

Geneva
March 30, 2017



DM/087 143



DM/087 143



DM/088 829

Who are we?



Where to ask for protection?

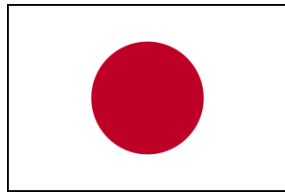

1999 Act



1960/1999 Act



1960 Act



1999 Act



1999 Act

Who can file an application?

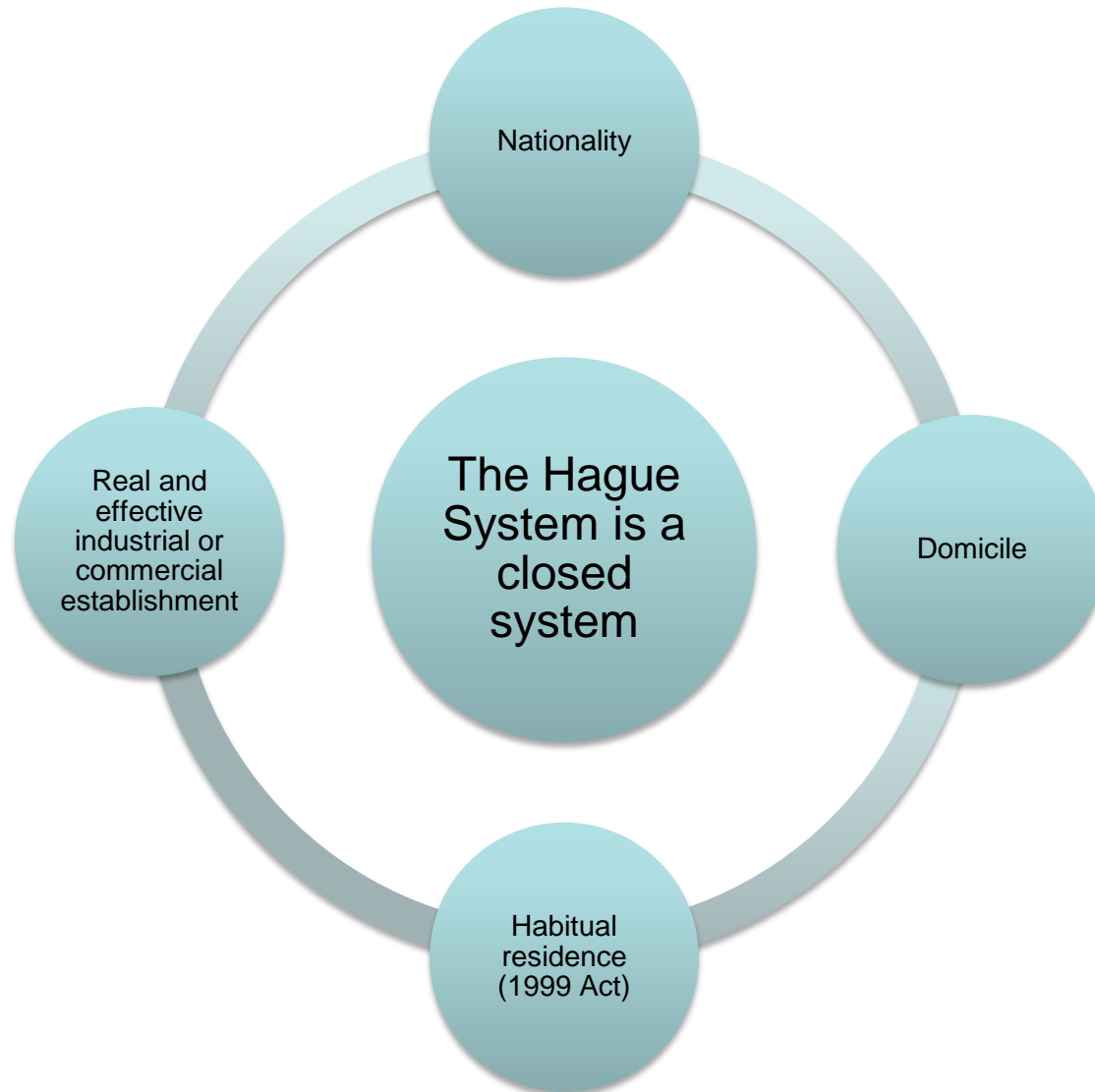

Entitlement



1999 Act



1960 Act



1960/1999 Act

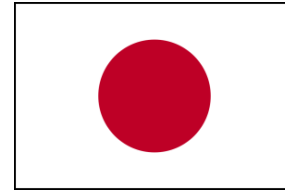

1999 Act



1999 Act



1999 Act

Entitlement



1960 Act



1960/1999 Act

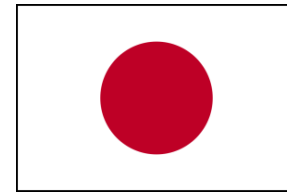

1999 Act



1999 Act



1999 Act

Entitlement



1960 Act



1960/1999 Act

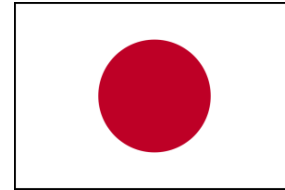

1999 Act



1999 Act



1999 Act



Not a member



1999 Act

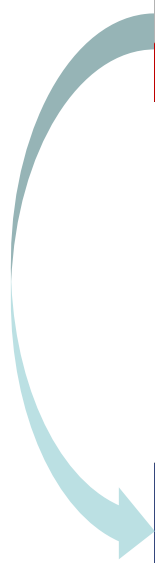

Entitlement



1960/1999 Act

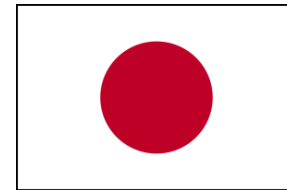

1999 Act



1999 Act



1999 Act

How to file an application? - Good to know

NO national application is required

It is possible to designate the applicant's Contracting Party

NO subsequent designation

Declarations made by the CP to be taken into consideration

How to file an application?

- ❑ Directly with IB of WIPO
 - ❑ e-filing <https://www3.wipo.int/login/en/hague/index.jsp>
 - ❑ Paper (DM/1 form)
<http://www.wipo.int/hague/en/forms>

- ❑ Indirectly through the Office of the Contracting Party



Mandatory contents of an application

- Request for international registration
- Applicant's details
- Reproductions
- Product indication
- Indication of the designated CP
- Fees



Additional mandatory contents of an application

- Creator details and/or Oath of the creator
- Description
- Claim



Optional contents

- Creator
- Description
- Legend
- Priority claim
- International exhibition
- Publication

Optional contents

- Exception to the lack of novelty
- Relation with the principle design
- Appointment of the representative
- Information on eligibility for protection
- Economic status and certificate where applicable
- Locarno classification

Appointment of the representative



Requirements concerning the reproductions

- 16x16cm (max)
- 3cm (min) at least one of the reproductions
- 5mm left around the reproduction
- Reproductions numbered 1.1, 1.2, 1.3, 2.1, 2.2.....
- Industrial design against a neutral background
- Upright and right-angled

Three centimeters

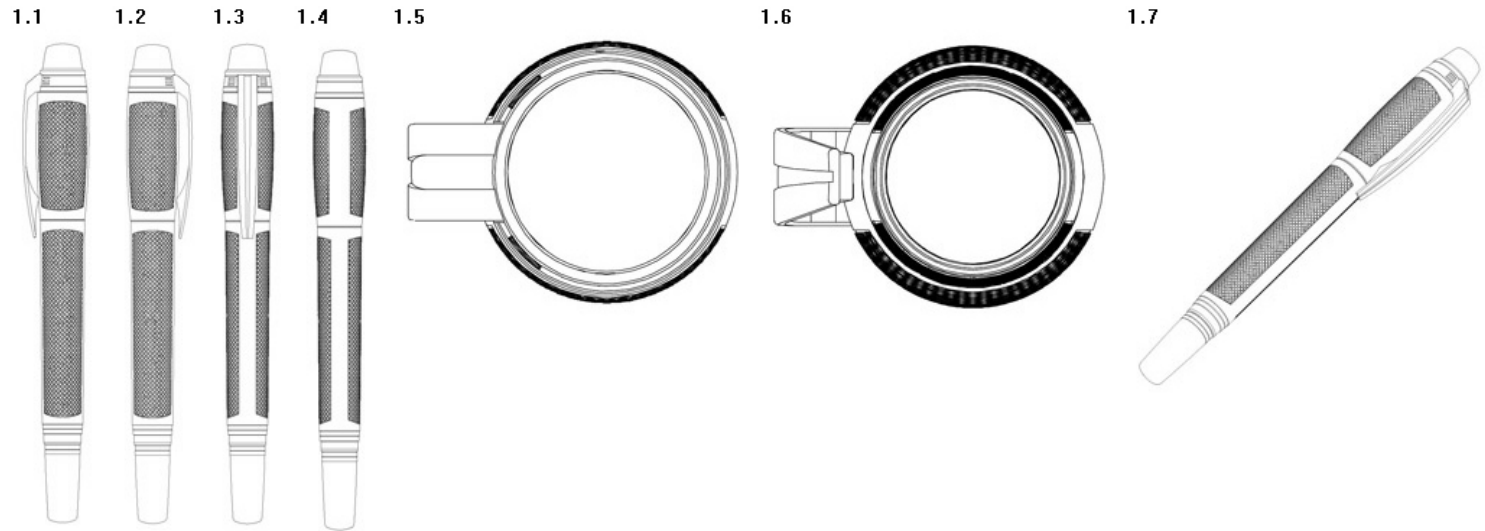

DM/082652

Black & White and color

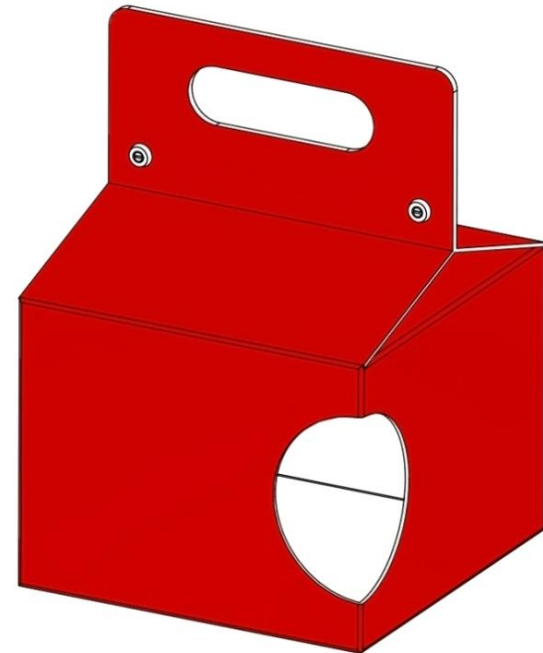
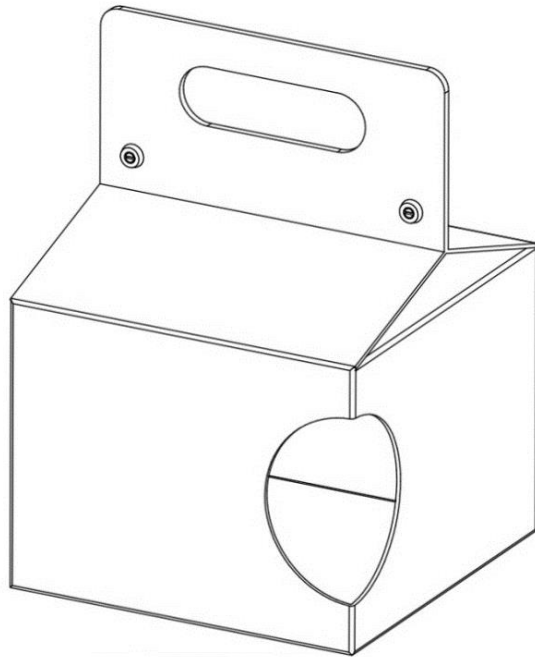

DM/093003 “Packaging for flexible pipes”

Black & White and color

Different **colors**



different **designs**

1.1

2.1



DM/078588 “Lavatory cleansing blocks”

Photographs and/or graphic representations

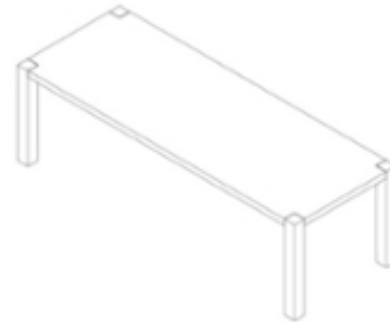

“DM/093893” “Tables”

Requirements concerning the reproductions

NO other objects, accessories, person or animal

NO technical drawings (axes & dimension)

NO explanatory text or legends

Other objects



DM/082846



Technical drawing

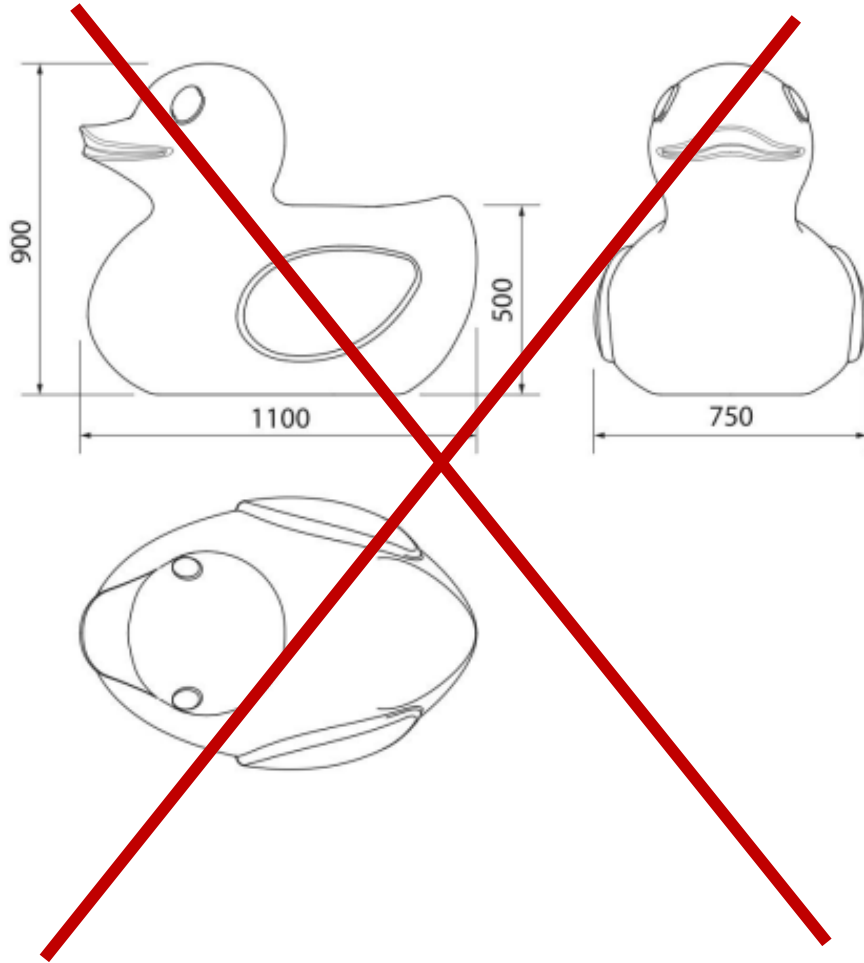

1.3

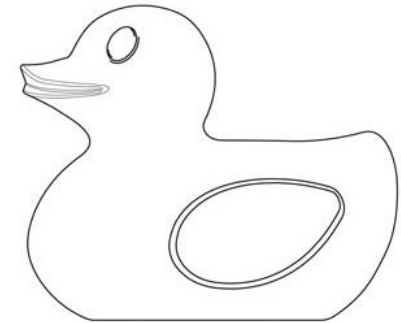

1.4

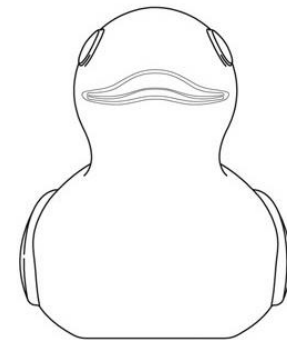

DM/084694

Disclaimer

Matter which is shown in a reproductions but for which protection is not sought may be indicated

- in description
and/or
- by means of dotted or broken lines or coloring

Disclaimer by coloring and description

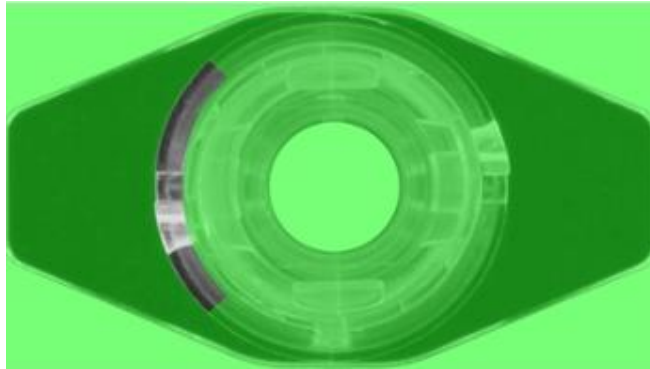
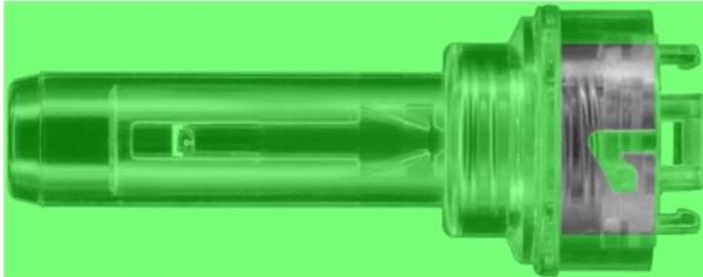

“The green colored parts form no part of the claimed design (disclaimer)”

DM/095191 “Safety device for syringe”

Disclaimer by broken lines and description

2.1

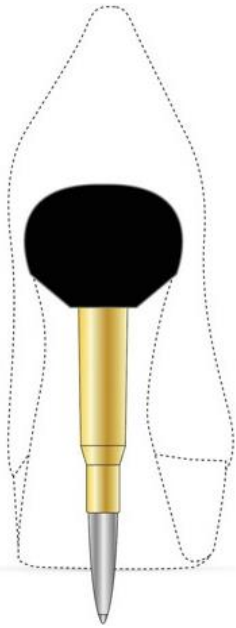

2.2



2.3

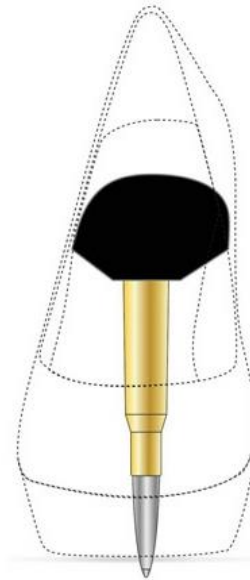

DM/082544 “Shoe”

“No protection is sought for the matters shown in dotted lines (disclaimer)”

Disclaimer of the accessories



DM/094315 “Cap of jars”

b) Notwithstanding Section 402(a), matter that does not form part of the industrial design or the product in relation to which the industrial design is to be used may be shown in a reproduction if it is indicated in accordance with paragraph (1)
(in force on July 1, 2014)

Disclaimer by coloring

1.1



1.3

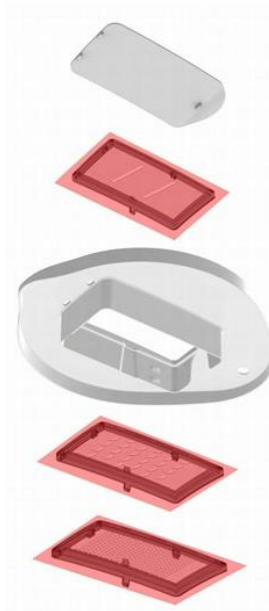

1.2



DM/080877 “Lid [household]”

Description

- Appearance of design
- Possible utilization
- View omitted
- Disclaimer
- Legends

Description - Legends

1.1

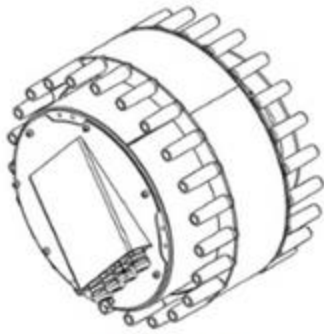

1.1) Perspective

1.2

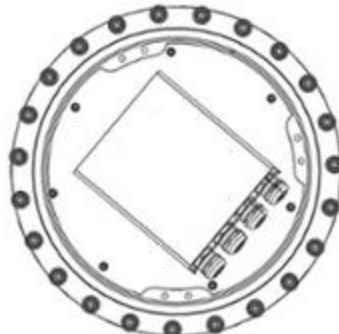

1.2) Left

1.3

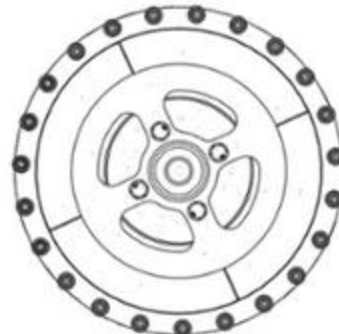

1.3) Right

DM/095106; “Drive module assembly for vehicles”

Description:

Figure 1.1 is a perspective view of a drive module assembly for vehicles; figure 1.2 is a left view of a drive module assembly for vehicles; figure 1.3 is a right view of a drive module assembly for vehicles.....

Description - Views omitted



DM/084264; “Watch dial”

POSSIBLE description:

“Right side, top and bottom views are omitted because they are identical or mirror image of the left side view”

Description - Visible features only



DM/095114; “Ornamentation”

Description:

On a yellow background there is a green meadow of different shaped green plants; above the green meadow there are five butterflies; two of the butterflies are striped in red and white with a banner at the end; the other three butterflies are white

Description - Possible utilization



DM/084820; “Heel protector”

Description:

Heel protection designed to protect the back of shoes or sandals against rubbing or damage while driving or traveling and to improve safe driving

Product indication

- ❑ Specific and usually generic name

Lightening device



Table lamp

Communication equipment



Mobile phone

Footwear article



Boot

- ❑ One per design

Carpets, mats or rug



Bathroom mat

Ornamentation, graphic symbol or logo



Logo

Product indication

- ❑ Can be a part of the product or product itself

1.1

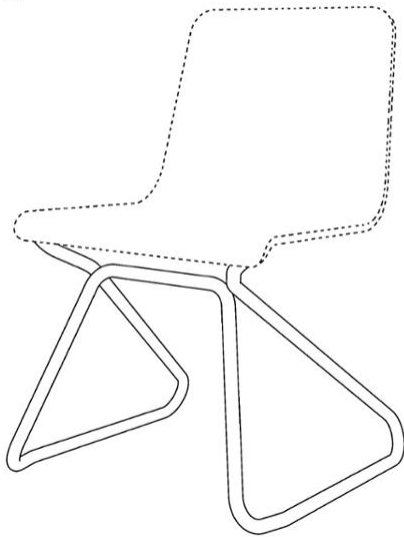

1.2

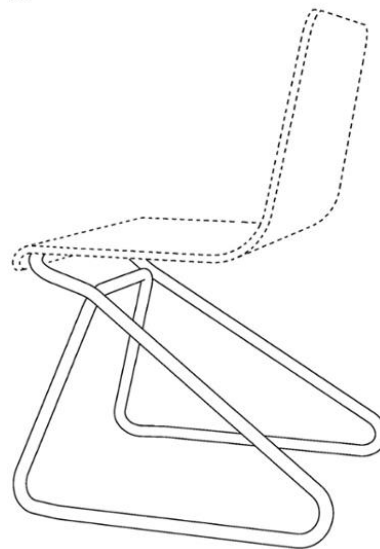

“Furniture leg”



“Chair”

DM/090308

Product indication and Locarno classification

- ❑ Industrial designs are classified in accordance with the product indication

Class 32-00

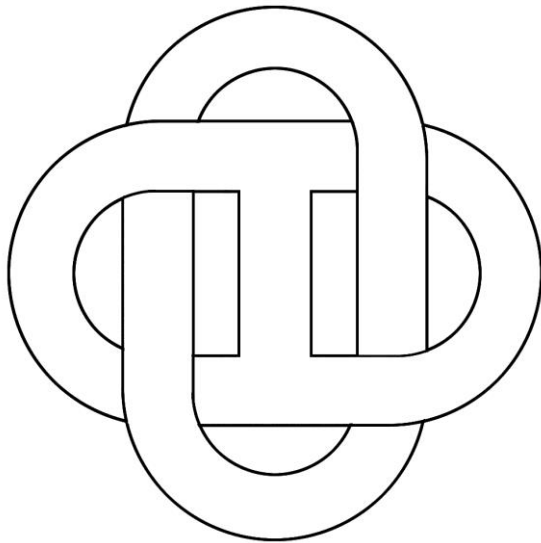

DM/081718; “Ornamentation”

Class 09-05



DM/084887; “Ornamentation for packaging bags”

Locarno classification - Mono class

Class 6

2.2



Chair

7.1



Dining table

3.1



Cabinet

13.1



Sofa

21.1



Corner table

DM/083137

Locarno classification: Multiple classes

Class 12



DM/081329

Class 6



DM/073710

Class 26



DM/084440

Irregularities

- 3 months - filing date is affected
- 3 months - registration date is affected
- 3 months - date is not affected
- 1 month observation with possibility to response
- Observation for information

Irregularities affecting FILING date

NOT in the language prescribed

English

French

Spanish

NO applicant details

NO reproductions

NO CP designated



Irregularities affecting REGISTRATION date

- Creator details
- Description
- Claim





DM/087 143



DM/087 143

Class 3

Class 2



DM/088 829

Certificate



EUIPO, JPO, KIPO, USPTO say **YES!**

1.1



1.1) Perspective

1.2



1.2) Front

1.3



1.3) Back

1.4



1.4) Left

1.5



1.5) Right

1.6



1.6) Bottom

1.7



1.7) Top

[DM/087 141](#)

EUIPO, JPO, KIPO, USPTO say **YES!**

1.1

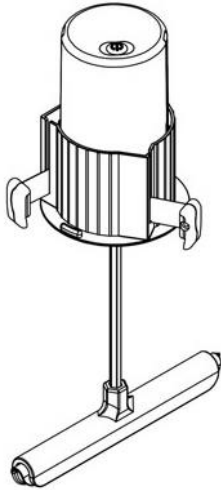

1.2

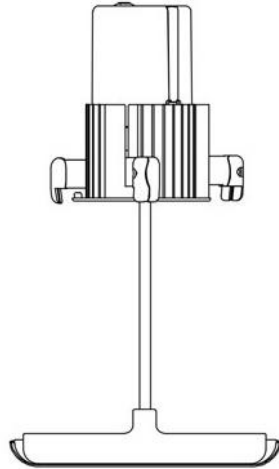

1.3

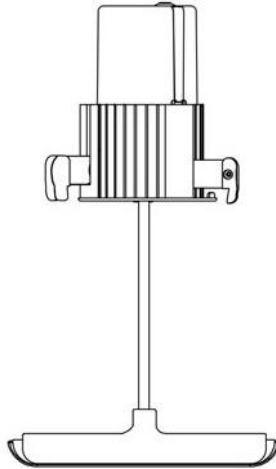

1.4

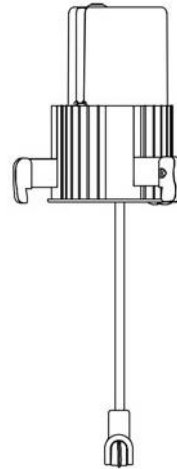

1.5

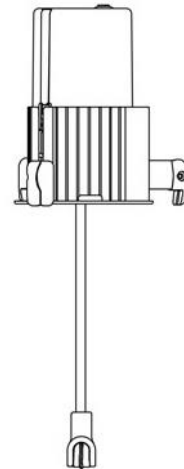

1.6

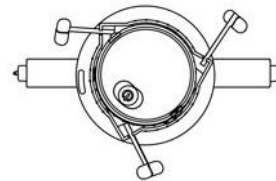

1.7

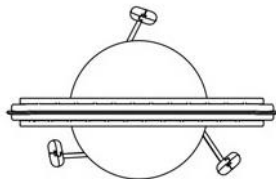

[DM/087 227](#)

EUIPO, JPO, **KIPO**, USPTO say **YES!**



[DM/088 771](#)



Administration of an IR

Renewal

Renunciation & Limitation

Change in Ownership

Changes in holder's/representative's details

Renewal

□ Duration of Protection

□ Initial term: five years

□ Minimum duration

➤ 1960 Act: 10 years (5 + 5)

➤ 1999 Act: 15 years (5 + 5 + 5)

□ maximum duration in each CPs:

(see declarations of CPs:



<http://www.wipo.int/hague/en/declarations/declarations.html>)

Renewal – Scope

Total renewal

Partial renewal

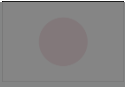
- for SOME of the designated CPs only
- for SOME of the designs only

| Designated CPs | Bag 1 | Bag 2 | Bag 3 |
|---|-------|-------|-------|
|  | ✓ | ✓ | ✓ |
|  | ✓ | ✓ | ✓ |
|  | ✓ | ✓ | ✓ |
|  | ✓ | ✓ | ✓ |

Renewal – Scope

Total renewal

Partial renewal

- for SOME of the designated CPs only
- for SOME of the designs only

E-renewal: « tailor-made » renewal

| Designated CPs | Bag 1 | Bag 2 | Bag 3 |
|---|-------|-------|-------|
|  | ✓ | | ✓ |
|  | | | ✓ |
|  | | ✓ | |
|  | | ✓ | ✓ |

Renewal – Good to Know

Possible

- Maximum period expired
- Refusal recorded



Not Possible

- Renunciation recorded
- Limitation recorded
- Invalidation recorded



Renunciation and Limitation

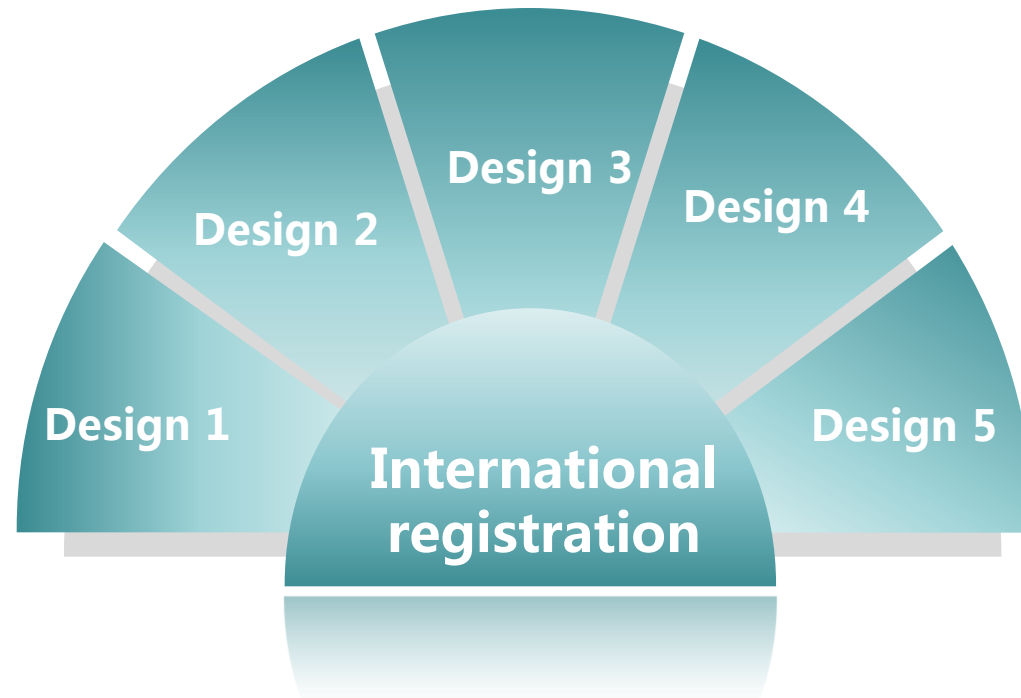

Renunciation and Limitation





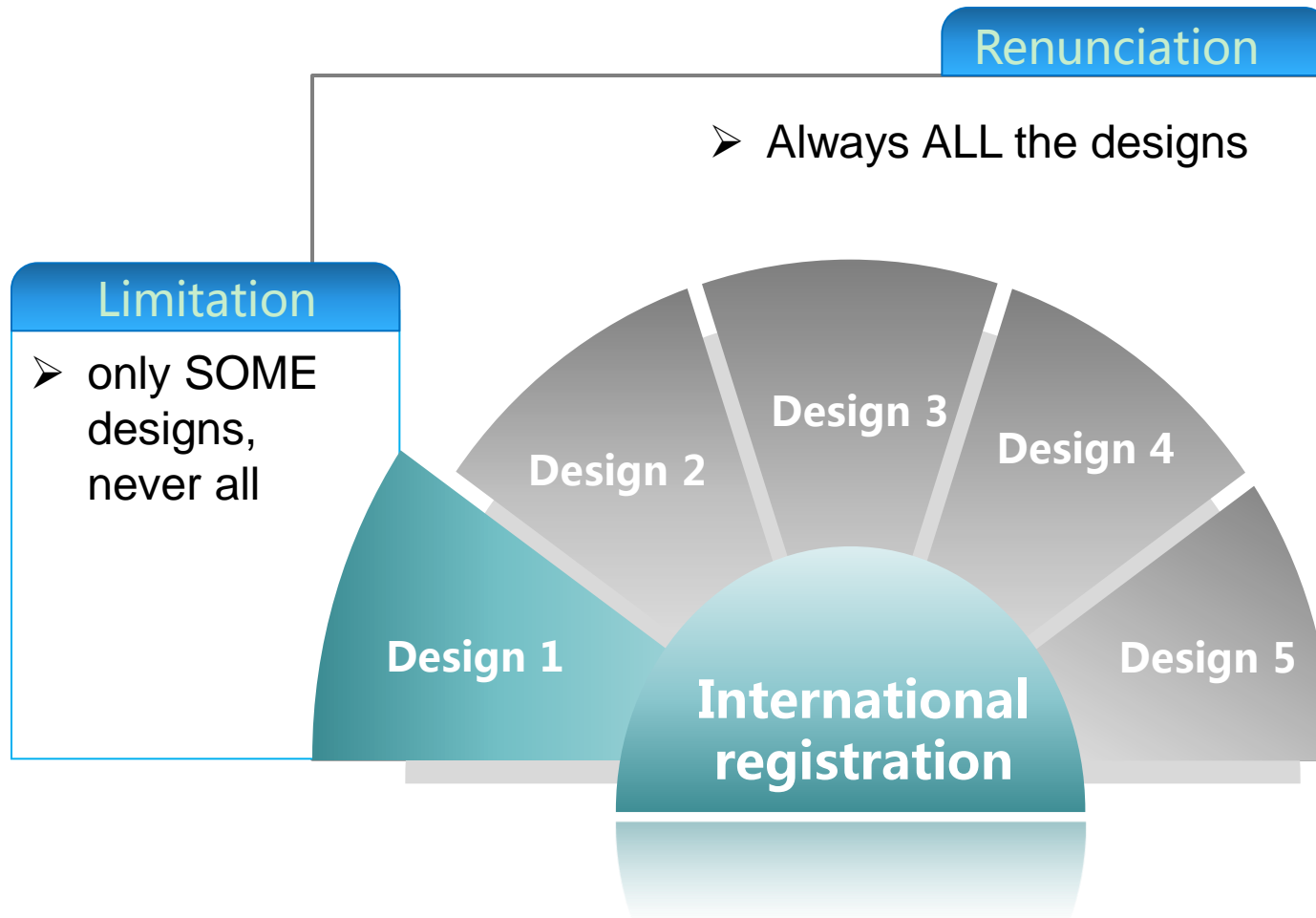

Renunciation and Limitation





Renunciation

- ❑ Total renunciation:
 - ❑ ALL designated CPs

| Designated CPs | Design 1 | Design 2 | Design 3 |
|---|----------|----------|----------|
|  | ✓ | ✓ | ✓ |
|  | ✓ | ✓ | ✓ |
|  | ✓ | ✓ | ✓ |
|  | ✓ | ✓ | ✓ |

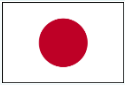

Renunciation

- Total renunciation:
 - ALL designated CPs
- Partial renunciation:
 - SOME designated CPs

| Designated CPs | Design 1 | Design 2 | Design 3 |
|---|----------|----------|----------|
|  | ✓ | ✓ | ✓ |
|  | ✓ | ✓ | ✓ |
|  | ✓ | ✓ | ✓ |
|  | ✓ | ✓ | ✓ |

Limitation

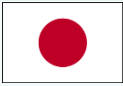
- ❑ Request form: DM/3 (mandatory)
- ❑ Only concerns **SOME** of the designs, **NEVER ALL**
 - **ALL** designated CPs
 - **SOME** of the designated CPs

| Designated CPs | Design 1 | Design 2 | Design 3 |
|---|----------|----------|----------|
|  | ✓ | ✓ | ✓ |
|  | ✓ | ✓ | ✓ |
|  | ✓ | ✓ | ✓ |
|  | ✓ | ✓ | ✓ |

Change in ownership

- ❑ Request form: DM/2 is mandatory

- ❑ Who can present the request?
 - ❑ signed by the holder, or
 - ❑ signed by the new owner + attestation from competent authority of the holder's CP that the new owner appears to be the successor in title of the holder

Change in ownership – Entitlement

- ❑ The *new* owner should be **entitled** to file an international application
 - ❑ Nationality
 - ❑ Domicile
 - ❑ Real and effective industrial or commercial establishment
 - ❑ Habitual residence (the 1999 Act only)

- ❑ There should be a **common treaty** between the *new* owner's CP(s) and each designated CP

Change in ownership – Entitlement

Current holders



1960 Act



1999 Act



members of EU



1999 Act

New owner



1960 Act

Designated CPs



1960/1999 Act

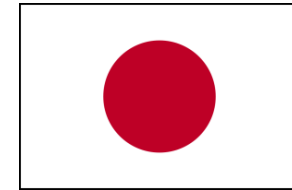

1999 Act



1999 Act



1999 Act

| **HAGUE**

The International
Design System

Change in ownership – Entitlement

New owner



1960 Act

Designated CPs



1960/1999 Act

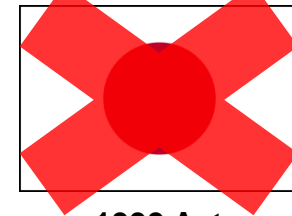

1999 Act

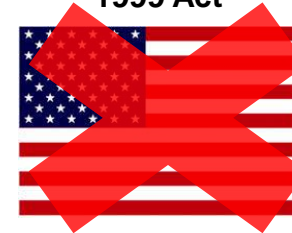

1999 Act

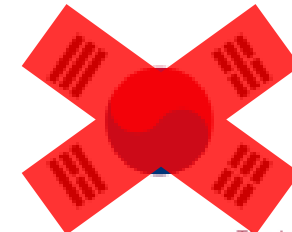

1999 Act

| HAGUE

The International
Design System

Change in ownership – Result

Previous holders



1960 Act



1999 Act



New holder



1960 Act

Designated Countries

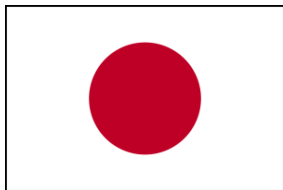

1999 Act



1999 Act



1999 Act



1960/1999 Act





Change in ownership – Scope

Total change

Partial change

for SOME of the designated CPs only

for SOME of the designs only





| Designated CPs | Design 1 | Design 2 | Design 3 |
|---|----------|----------|----------|
|  | ✓ | ✓ | ✓ |
|  | ✓ | ✓ | ✓ |
|  | ✓ | ✓ | ✓ |
|  | ✓ | ✓ | ✓ |

Change in ownership – Scope

Total change

Partial change

- for SOME of the designated CPs only
- for SOME of the designs only
- « tailor-made » change

| Designated CPs | Design 1 | Design 2 | Design 3 |
|---|----------|----------|----------|
|  | | | |
|  | | ✓ | |
|  | | | |
|  | | ✓ | |

Change in ownership – **NO** Effect

❑ Article 16(2) of the 1999 Act

❑ has NO effect until the Office received the statements or documents specified in the declaration

➤ *OAPI, DK, KR, US*

❑ recording of a partial change in ownership is NOT allowed

Changes in holder's/representative's details

Change in the name/address of the holder

Appointment of a representative

Change in the name/address of the representative

Cancel a recorded representative

Change in ownership vs. Change in name

Change in Ownership

The holders will be changed



Change in ownership vs. Change in came

Change in Name of holder

the SAME holders



Tips

Link of request forms:

➤ <http://www.wipo.int/hague/en/forms/>

Fee calculator:

➤ <http://www.wipo.int/hague/en/fees/calculator.jsp>

Schedule and Payment of fees:

➤ <http://www.wipo.int/hague/en/fees/sched.htm>

Handwriting NOT allowed

Have to be signed by holder or representative recorded

Irregularity shall be remedied within 3 months

