

INTRODUCTION TO THE MADRID SYSTEM

Kazutaka SAWASATO
Legal Section
The International Trademarks Registry



Table of Contents

Madrid System

- Overview
 - Legal Framework & Geographic Scope
 - Objectives & Entitlement to File
- Basic Features
 - Basic Principles
 - National Route vs. Madrid Route
 - Agreement vs. Protocol
- International Application
 - Role of the Office of Origin
 - Role of the International Bureau
- International Registration
 - Effects of the International Registration
 - Refusals
- Managing the International Registration I
 - Subsequent Designation
 - Changes in the International Registration
- Managing the International Registration II
 - Ceasing of Effect
 - Renewal



Legal Framework & Geographic Scope



Legal Framework

Madrid System Concerning the International Registration of Marks

- Madrid Agreement (1891)
- Madrid Protocol (1989)
- Common Regulations (1996)
- Admin. Instructions (2002)
- National Laws & Regulations



Madrid Union – 84 Members



Madrid System

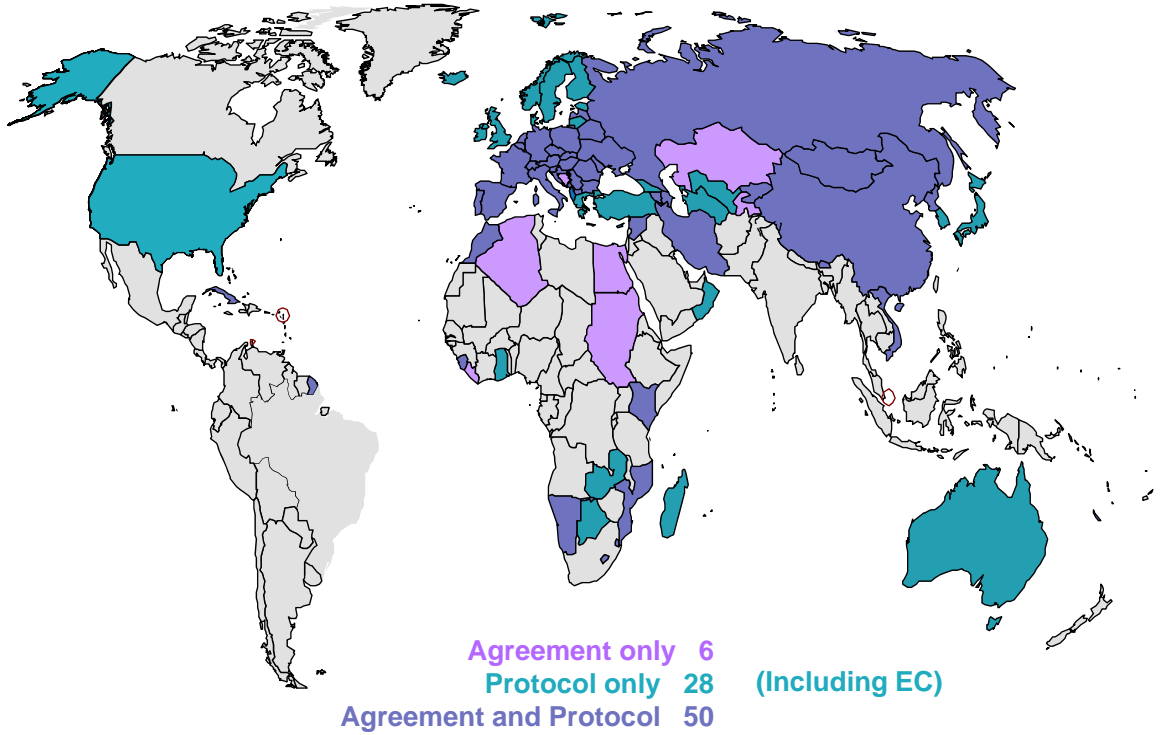

Madrid Union – 84 Members



Madrid System

Madrid Protocol - 78
 Madrid Agreement - 6

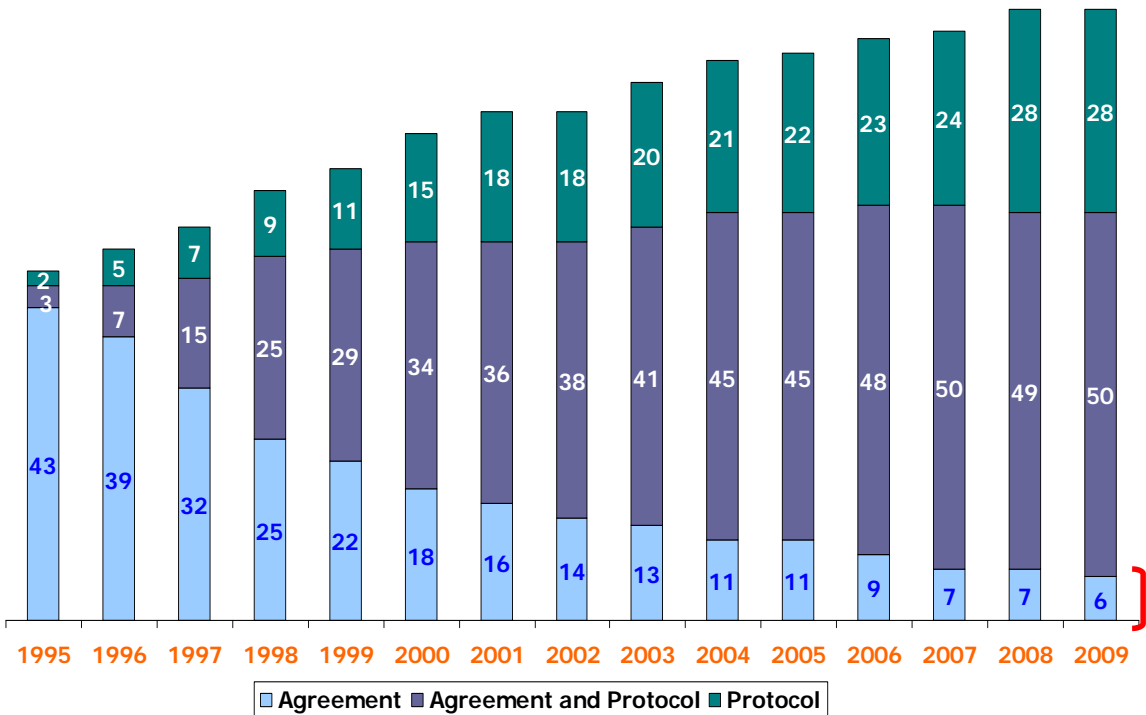

Madrid Union – 84 Members



Madrid System

- Madrid Agreement Only
 - 6 Contracting Parties (EG*, KZ, SD, ...)
- Madrid Protocol Only
 - 28 Contracting Parties (EM, JP, US, ...)
- Agreement & Protocol
 - 50 Contracting Parties (CN, DE, RU, ...)

* The Madrid Protocol will enter into force with respect to Egypt on September 3, 2009.

Madrid System

Objectives & Entitlement to File



Objectives

Madrid System

- Facilitating trademark protection in export markets through a simple, expeditious and cost-effective procedure for:
 - the central filing of applications
 - the central management of registrations

Entitlement to File an International Application

Madrid System

- Someone ...
 - Natural person
 - Legal Entity
- ... that has a connection
 - Establishment
 - Domicile
 - Nationality
- ... with a Member of the Madrid Union.
 - Contracting State / Organization

Basic Principles

Basic Principles

- Basic application or basic registration ("Basic Mark") in a Contracting Party of the Madrid System
- Connection between owner named in the basic mark and that Contracting Party
- Filing through an Office of Origin
- must designate one or more *other* Contracting Parties with common treaty (a self-designation is not possible)
- Set time limits for refusal
- Subsequent Designation
- Dependence on the Basic Mark for 5 years
- Centralized management of International Registration



National Route vs. Madrid Route

National Route vs. Madrid Route

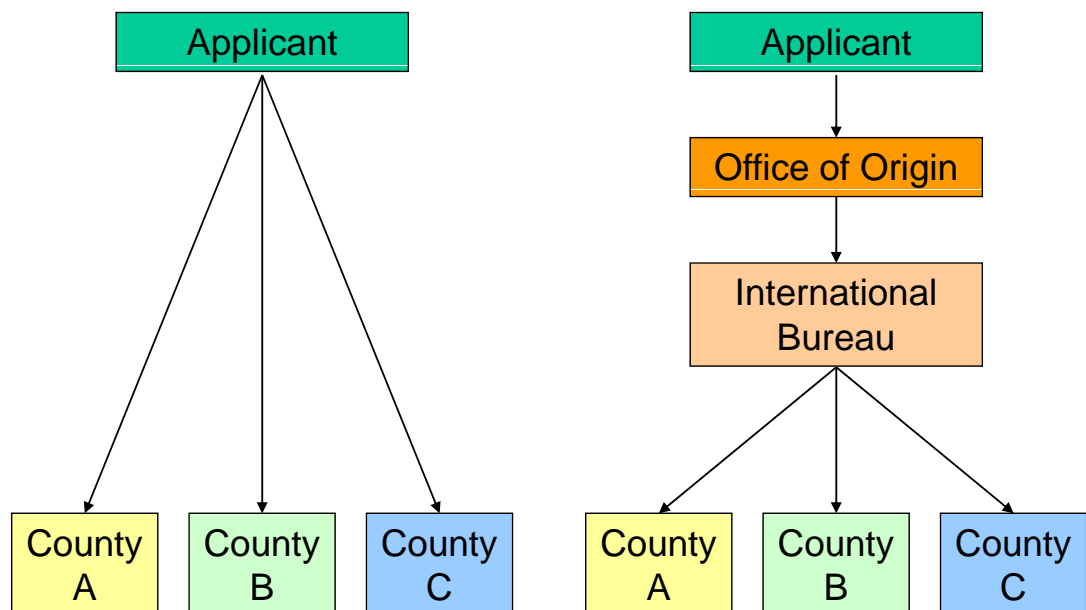

National Route vs. Madrid Route



Madrid System

National Route

- **many** procedures
- **many** forms
- **many** languages
- **many** fees
- **many** currencies
- **many** registrations
- **many** modifications

Madrid Route

- **one** procedure
- **one** form
- **one** language
- **one** set of fees
- **one** currency
- **one** registration
- **one** modification

Agreement vs. Protocol

Madrid System



Agreement vs. Protocol



Madrid System

	<u>Agreement</u>	<u>Protocol</u>
Members	States	States and Organizations
Basic mark	Basic Registration	Basic Registration and Basic Application
Fees	Supplementary and Complementary	or Individual fee
Refusal	12 months	or 18 months or 18 + months
Dependency	5 years	5 years with possible transformation

* The list is not exhaustive.

Applicable Treaty



Madrid System

Which treaty will govern a given designation ?

- Rule 1: The Contracting Party of origin and a designated Contracting Party must have at least one treaty in common. Then, that treaty shall apply.
- Rule 2: Between Contracting Parties to the Agreement and the Protocol, the Protocol shall be applicable.

3 Types of Applications

Madrid System

- Rule 1(viii): Governed exclusively by Agreement
 - all designations governed by Agreement

MM1

- Rule 1(ix): Governed exclusively by Protocol
 - all designations governed by Protocol

MM2

- Rule 1(x): Governed by Agreement and Protocol
 - some designations governed by Agreement
 - some designations governed by Protocol

MM3

Designations of Contacting Parties: Agreement

Madrid System

- International application governed exclusively by the Agreement
 - Use official form **MM1**

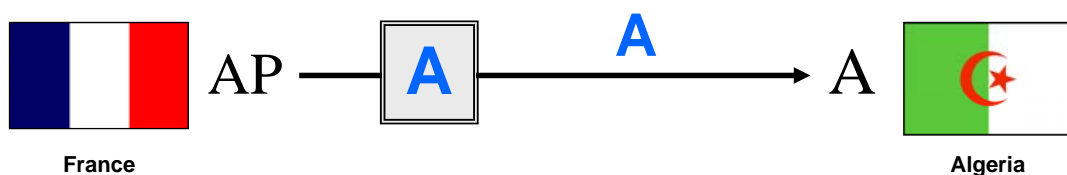

Designations of Contacting Parties: Protocol



Madrid System

- International application governed exclusively by the Protocol
 - Use official form MM2

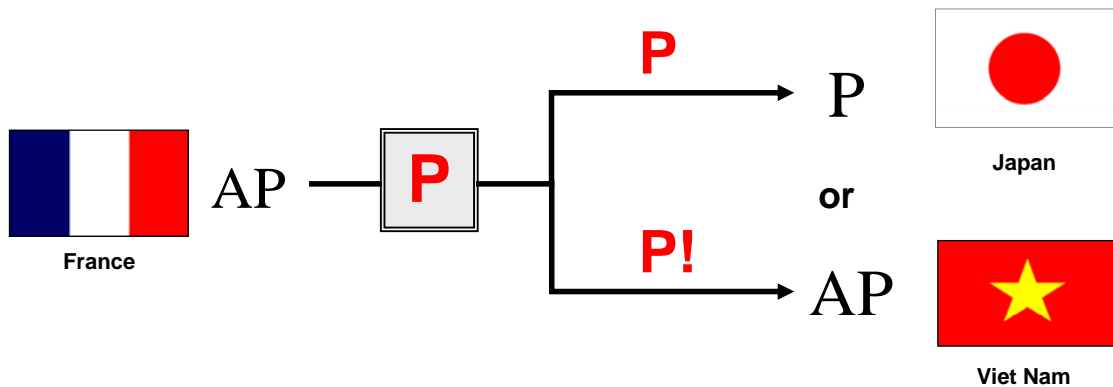

Designations of Contacting Parties: Mixed



Madrid System

- International application governed by both the Agreement and the Protocol
 - Use official form MM3

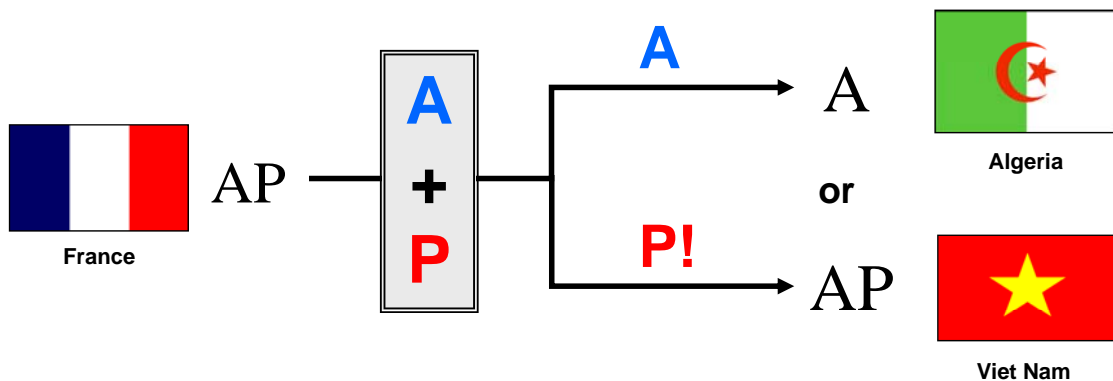



International Application

Role of the Office of Origin

Role of the International Bureau

Application/Registration Flow

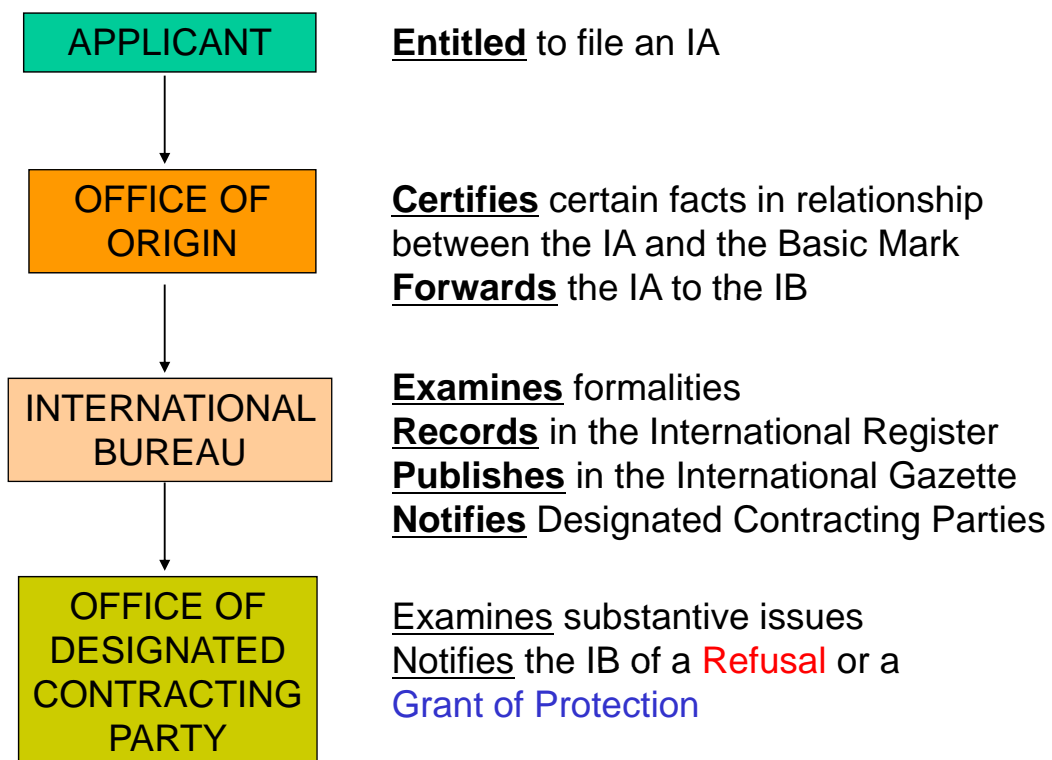

Role of the Office of Origin

Madrid System

- **Certifies**

- Date of receipt of the request to present the international application
- Identity of
 - Applicant
 - Mark
 - Goods and Services
- Designation

- **Forwards** international application to International Bureau in a timely manner, as required

Examination and Registration Process within the IB

Madrid System

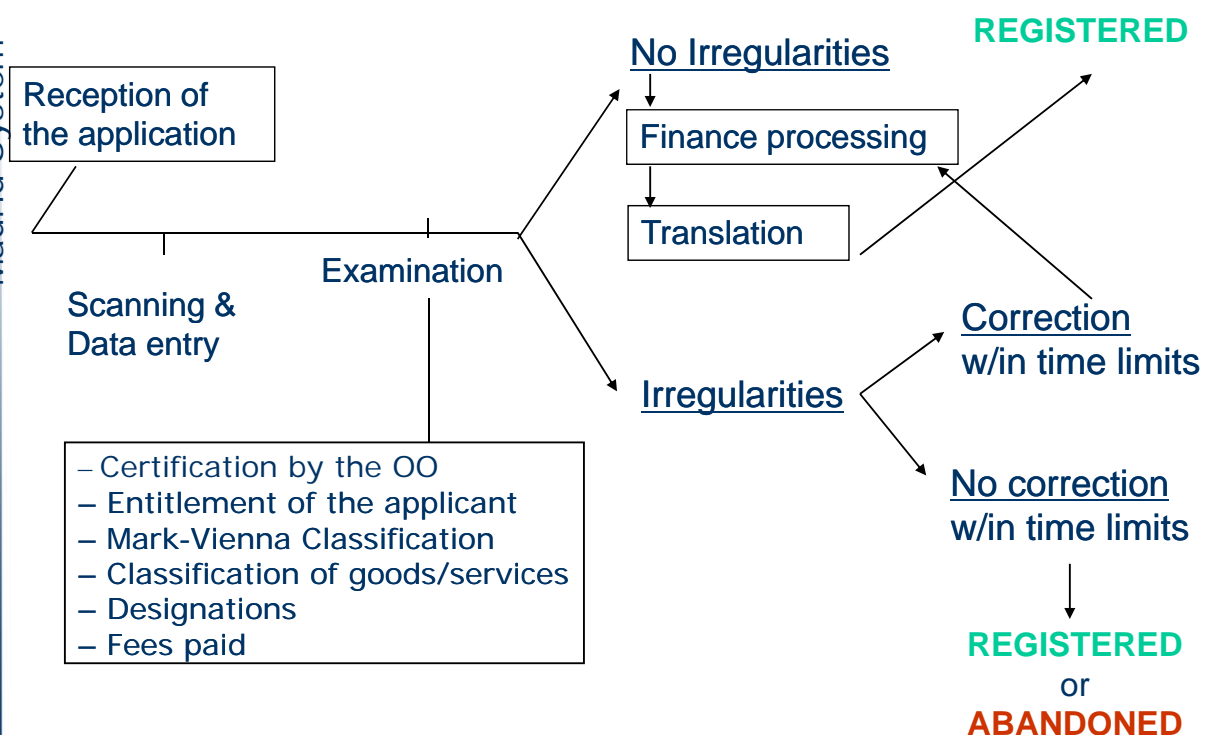

Irregularities to be remedied by the Office of Origin



Madrid System

- Rule 12
 - Irregularities with respect to Classification of Goods and Services
- Rule 13
 - Irregularities with respect to Indication of Goods and Services
- Rule 11 (4)
 - Other irregularities

Classification of G& S – Rule 12 –



Madrid System

- The IB considers that the G&S should be classified in a different class or have not been classified
- Correction by the Office of Origin
- The IB has the "*last word*" (Article 3 (2))

Article 3 International Application

(2) ... In the event of disagreement between the said Office and the International Bureau, *the opinion of the latter shall prevail.*

Indication of G & S – Rule 13 –



Madrid System

- The IB considers that a term indicated is:
 - too vague for the purposes of classification
 - linguistically incorrect
 - Incomprehensible
- Correction by the Office of Origin

Other Irregularities – Rule 11 (4) –



Madrid System

- Official form not used
- Applicant's entitlement
- Fundamental Omissions
 - Identity of
 - Applicant
 - Mark
 - Goods & Services
 - Designation

Role of the International Bureau



Madrid System

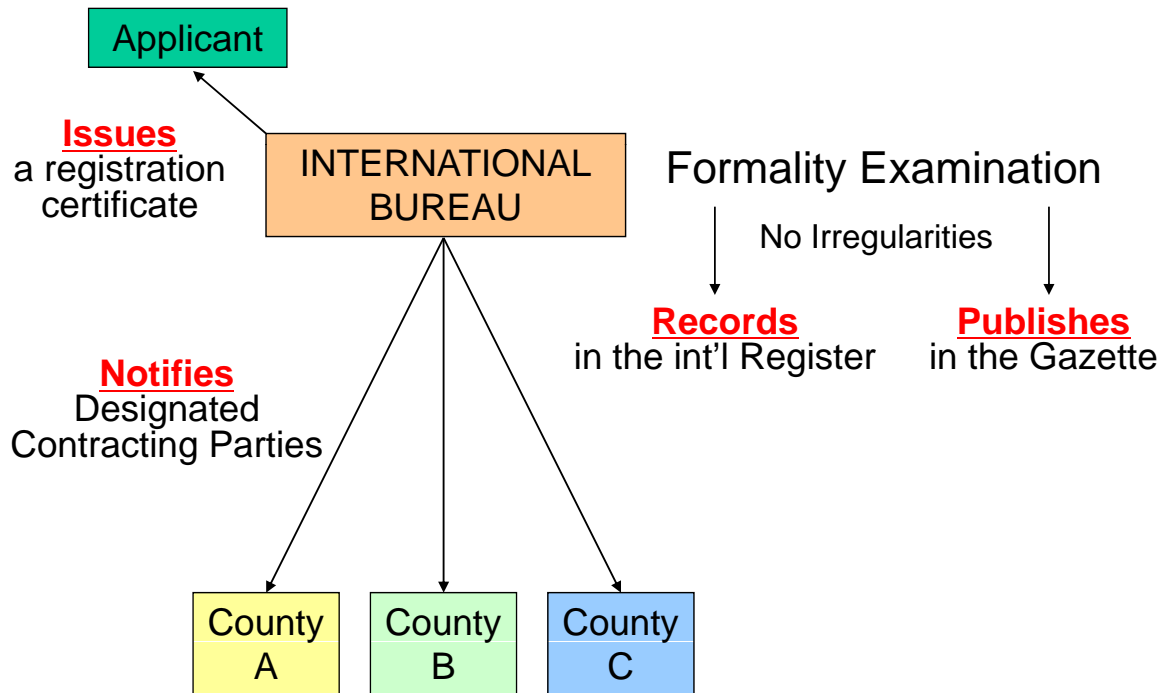

Certificate of Registration

Madrid System

Issued by
International
Bureau

WORLD INTELLECTUAL
PROPERTY ORGANIZATION

34, chemin des Colombettes, P.O. Box 16, CH-1211 Geneva 20 (Switzerland)
Tel.: (41 22) 338 9111 - Facsimile (International Registry of Marks): (41 22) 740 1429
E-mail: intreg.mail@wipo.int - Internet: http://www.wipo.int



MADRID AGREEMENT AND PROTOCOL

CERTIFICATE OF REGISTRATION

The International Bureau of the World Intellectual Property Organization (WIPO) certifies that the indications appearing in the present certificate conform to the recordal made in the International Register of Marks maintained under the Madrid Agreement and Protocol.

G. Bisson
Head
Examination and Registration Section
International Registrations Administration Department

Geneva, March 25, 2004

819 913

Registration date: January 13, 2004
Date next payment due: January 13, 2014

Esselte Corporation
48 South Service Road,
Suite 400,
Melville
New York 11747-2340
(United States of America)

Legal nature of the holder (legal entity) and place of organization: Corporation, New York, USA.
Name and address of the representative: Amy L. Nelkin, Esq.,
Darby & Darby, 805 Third Avenue, New York, NY 10022-
7513 (United States of America).

Colours claimed: Red. Entire mark is in the color red.
List of goods and services - NCL(8):
16 Filing system, namely, folders, guides, tabs, notecards, suspension members and cases.
Basic application: United States of America, 27.10.2003, 78/319.147.
Data relating to priority under the Paris Convention: United States of America, 27.10.2003, 78/319.147.
Designations under the Madrid Protocol: Australia, Belarus, Bulgaria, Democratic People's Republic of Korea, Iceland, Japan, Norway, Republic of Korea, Romania, Russian Federation, Switzerland, The former Yugoslav Republic of Macedonia, Ukraine.
Date of notification: 25.03.2004
Language of the international application: English



Classification of figurative elements:
26.1; 27.5; 29.1.

The process used does not allow in all cases the exact reproduction of all the different shades of colors



International Registration

Effects of the International Registration

Refusals

Effects of the International Registration – Article 4 –



The International Registration =

→ **A National Application**

until the expiry of the time limit to issue a refusal

→ **A National Registration**

once the time limit to issue a refusal has expired (assuming no refusal or refusal withdrawn)

Designated Contracting Parties



Madrid System

- What is the role of the Office of the Designated Contracting Parties?
 - No specific role
 - But possibility to issue a Refusal

Designated Contracting Parties



Madrid System

- *may* notify the IB of

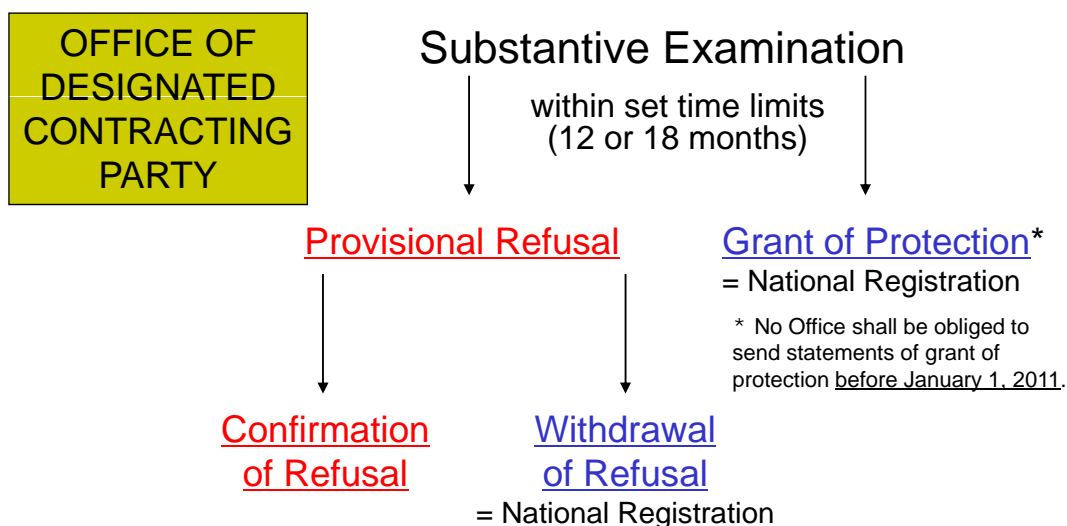

Time Limits



Madrid System

- Notification of *provisional* refusal:
 - 12 months
 - Mandatory under Agreement
 - Optional under Protocol
 - 18 months
 - Optional under Article 5(2)(b) of the Protocol
 - “18 months +” in case of opposition
 - Article 5(2)(c) of the Protocol

Non-Valid Grounds for Refusal



Madrid System

- Formal grounds
- Classification of the goods and services (Rule 12)
- Multi-class registration (Article 5(1))
- Limited goods or services (Article 5(1))

Managing the International Registration I

Subsequent Designation Changes in the International Registration

Subsequent Designation

- Can designate additional Contracting Parties after international registration
 - Subject to international procedures similar to those of a designation in an international application
 - Start date for protection
= recording of subsequent designation
 - Term and renewal of IR does not change
- Reasons
 - Indefinite term of trademark registration
 - Expansion of trade
 - Refusal ground no longer applies
 - New Contracting Parties

Presentation of the Subsequent Designation



Madrid System

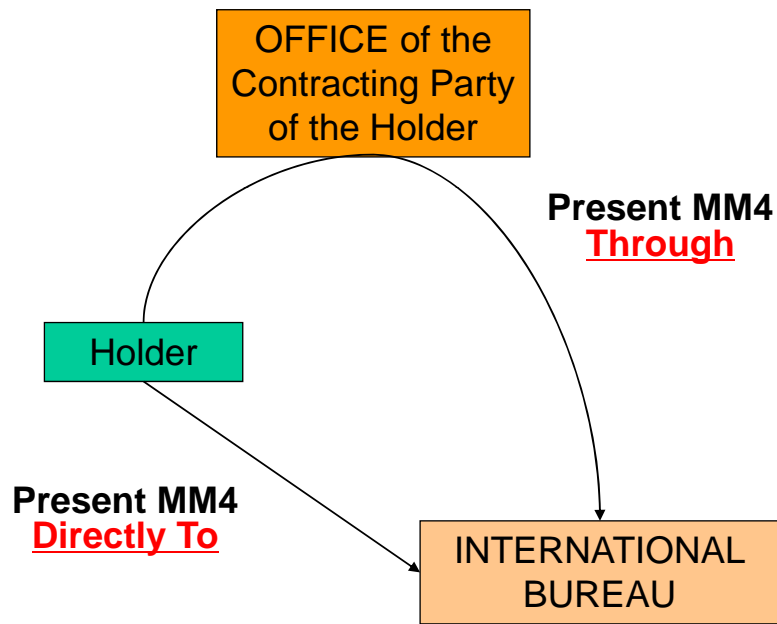

The International Bureau (SD)



Madrid System

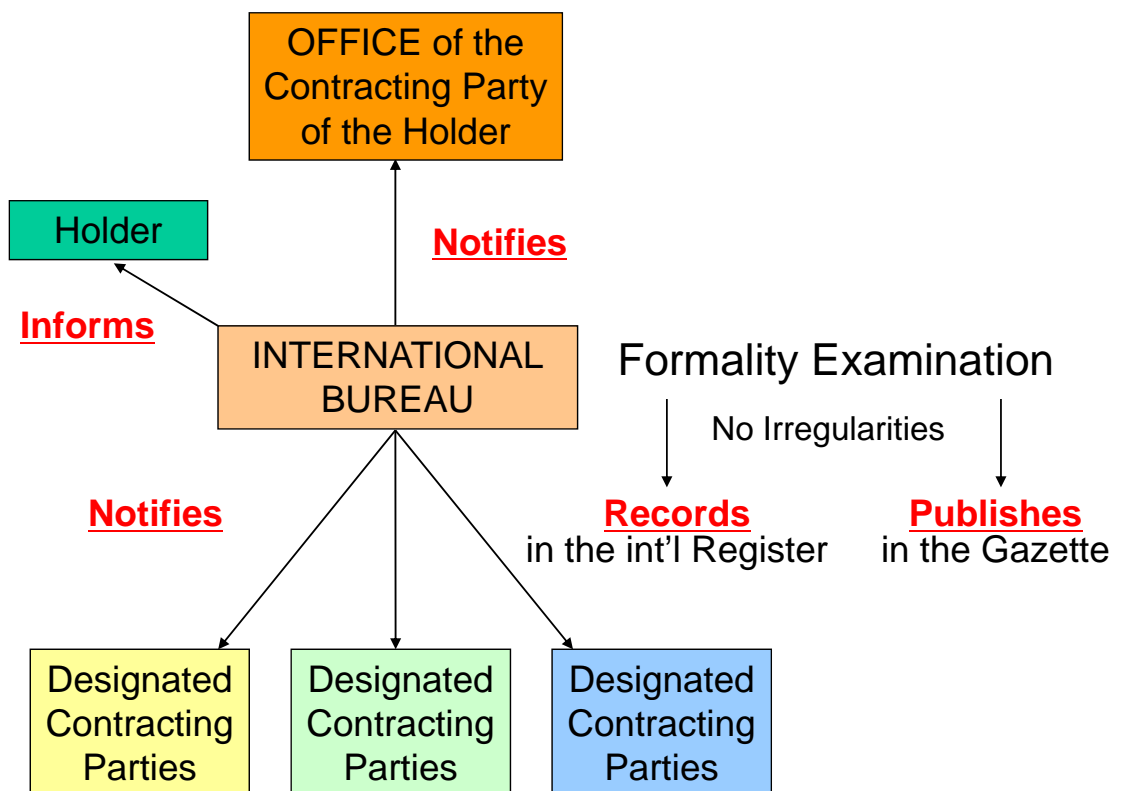

Changes in the International Registration



Madrid System

- Changes in the International Registration
 - Change in Ownership (MM5)
 - Limitation, Renunciation and Cancellation (MM6, 7, 8)
 - Change of Name or Address of the Holder (MM9)

Managing the International Registration II

Ceasing of Effect
Renewal

Madrid System

Ceasing of Effect

Madrid System

- For a period of five years from the date of its registration, the international registration remains dependent on the Basic Mark.
- If the Basic Mark ceases to have effect, the international registration will no longer be protected.
- Commonly called "Central Attack"

The International Bureau (CB)

Madrid System

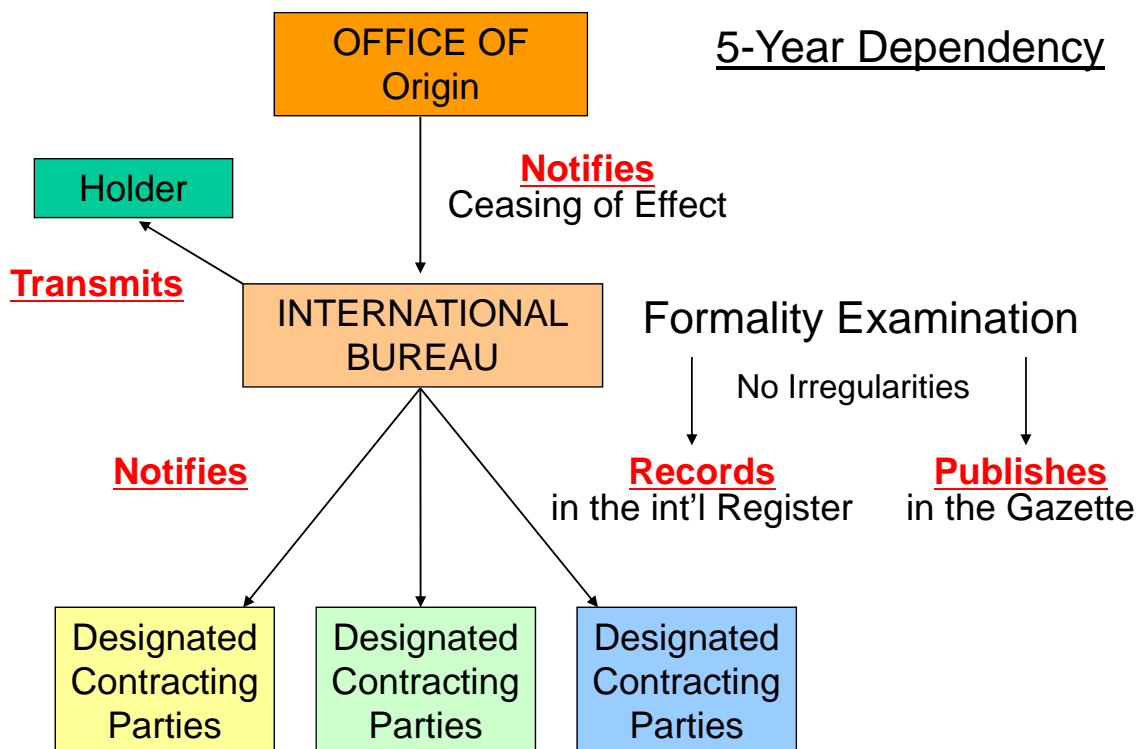

Cancellations Due to the Ceasing of Effect (Rule 22)



Madrid System

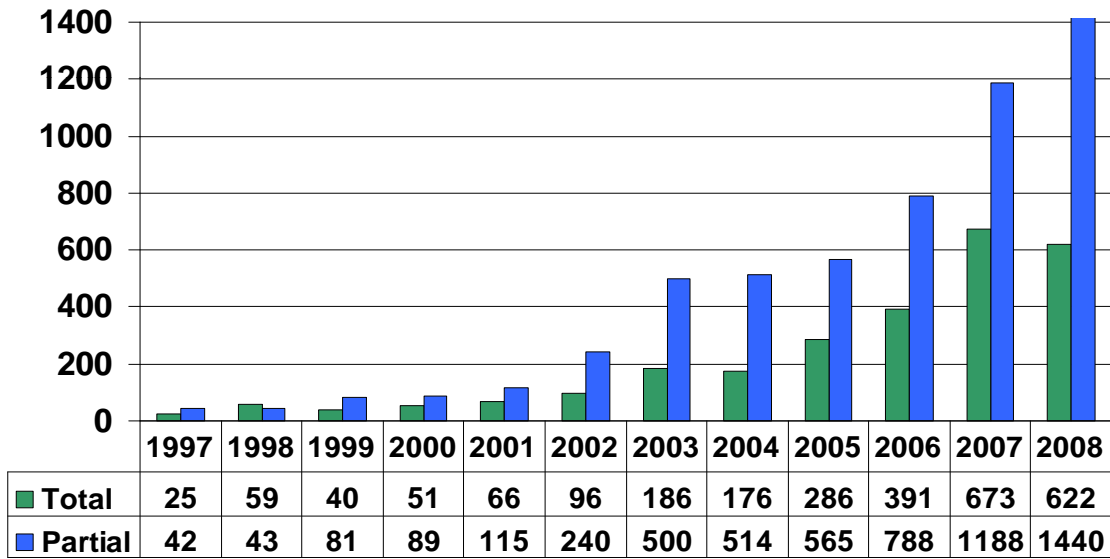

Cancellations Due to the Ceasing of Effect (Rule 22)



2008

Madrid System

Ceasing of Effect	IRs	% of IRs Registered 2003 - 2007
Total	622	0.40%
Partial	1,440	0.93%
Total + Partial	2,062	1.33%

WIPO Marks E-Renewal System

Please enter your International Registration Number (IRN): (for example: 123456, 123456A) *

* This application **renews** the international registration. **However**, in exceptional cases of international registrations which have been the subject of a limitation or other modification, the e-renewal system is not yet available as the number of classes per designated Contracting Party cannot be determined automatically. In such cases or for any other action concerning an international registration, please use the [Paper Forms](#) available on the WIPO web site.

Renewal

Renewal Procedures

- Unofficial notice of expiry
 - 6 months before expiry of 10 year period
- Payment
 - Any communication giving the necessary information + fees
 - Optional form (MM11) + fees
 - “E-Renewal” (online renewal of International Marks with payment by credit card)
- Fees are due
 - at the date of expiry at the latest
 - 6 months grace period (+ 50% basic fee)



Thank you

World
Intellectual
Property
Organization

