



أكاديمية البحث  
العلمي والتكنولوجيا  
Academy of Scientific  
Research & Technology



## أكاديمية البحث العلمي مكتب براءات الاختراع

عادل السعيد حسن عويضة  
رئيس مكتب براءات الاختراع



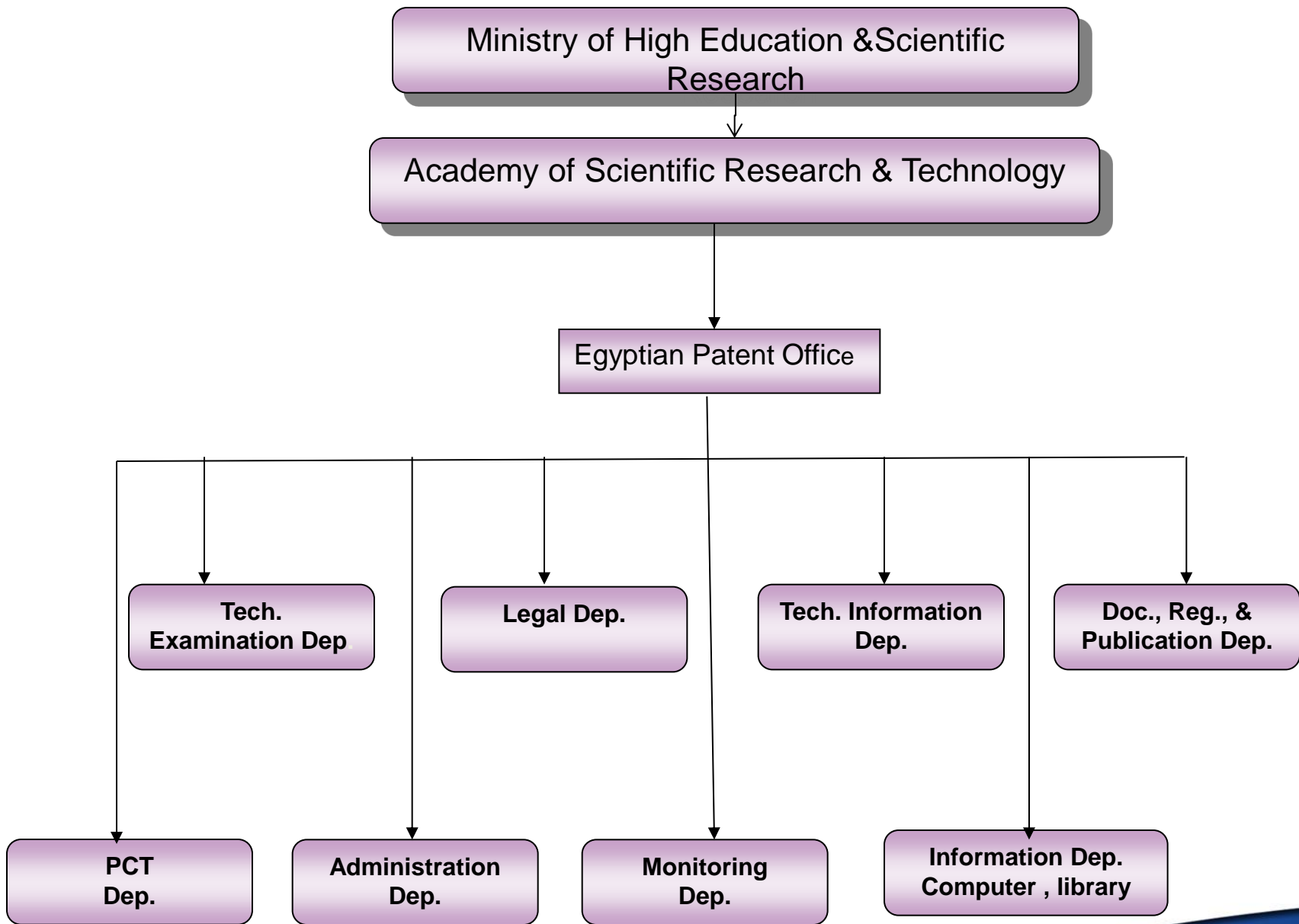

# Modernization of Egyptian Patent Office

- **Legislations (Intellectual Property Law )**
- **Administration System for Applying the Law**
- **Availability of IP information**
- **Encourage & Supporting Inventors**

# Legislations (Intellectual property law )

- The roots of the Intellectual Property in EGYPT go to 1949 by the law 132/1949
- The New Law 82/2002 which protect areas,
  - Patent , Utility Models
  - Layout-Designs for Integrated Circuits
  - Undisclosed Information
  - Micro-Organism
  - Protection of Pharmaceutical Product
  - Patent term of Protection 20 years
- Egypt is a member of WIPO since 1975
- Egypt is a member of Paris convention, Strasbourg agreement, TRIPS agreement, ...; and
- PCT Treaty member since June 6, 2003



# EG Patent Office Mandate

- **Protection According IP Law 82/2002 and Int. Treaties (Paris – TRIPS – PCT) For:**
  - **Patent**
  - **Utility Model**
  - **Integrated circuit**
- **Support Innovation and Scientific Research**



# EGPO ISA and IPEA

- The International Patent cooperation union Assembly at it's 17 session in October 2009 appointed the Egyptian patent Office as an International Searching and Preliminary Examination authority under the PCT
- The Egyptian Patent Office started as ISA and IPEA on April 2013



# البحث والفحص الدولي

## ■ البحث الدولي

EG	AT	EPO	USA	Int. search fee
\$300	\$648	\$637	\$520	Individual
\$400	\$2592	\$2545	\$2080	Company

## ■ الفحص الدولي

EG	AT	EPO	US	Exam. Fee
\$200	EUR 17 + 438	EUR 17+483	\$32+190	أفراد
\$300	EUR 163+ 1749	EUR 163+ 1930	\$ 221 +760	شركات



# Modernization of Egyptian Patent Office

Promoting innovation depends on Four factors:

- Legislations (Intellectual Property Law )
- Administration System for Applying the Law
- Availability of IP information
- Encourage & Supporting Inventors





# Administration System for Applying the Law

## Development of the Egyptian Patent Office



# Development of the Egyptian Patent Office

- The infrastructure;
- The human resources;
- The office procedure.

# Egyptian Patent Office , GeneralView Receiving Office



# Intranet

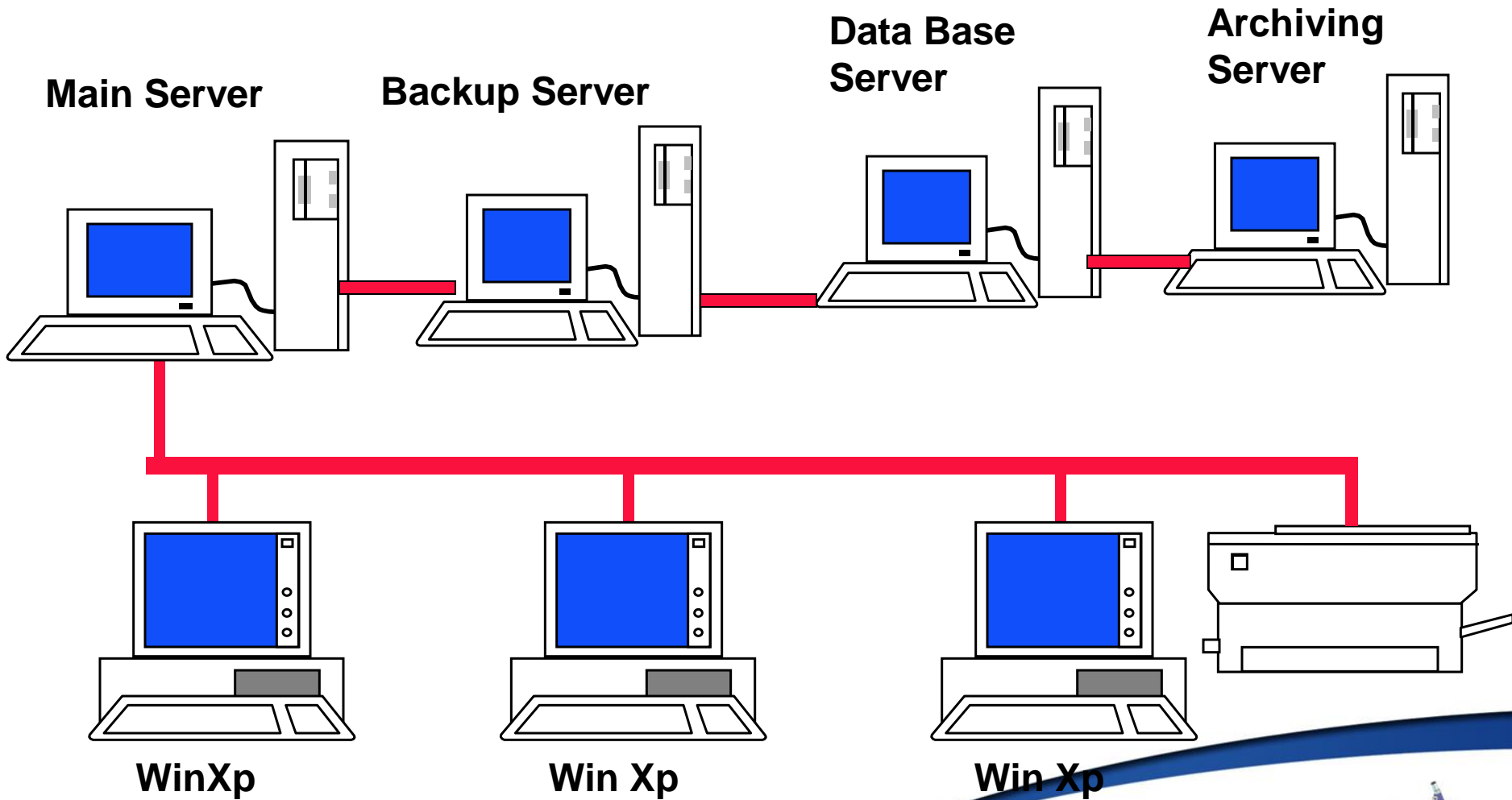

# Internet Network

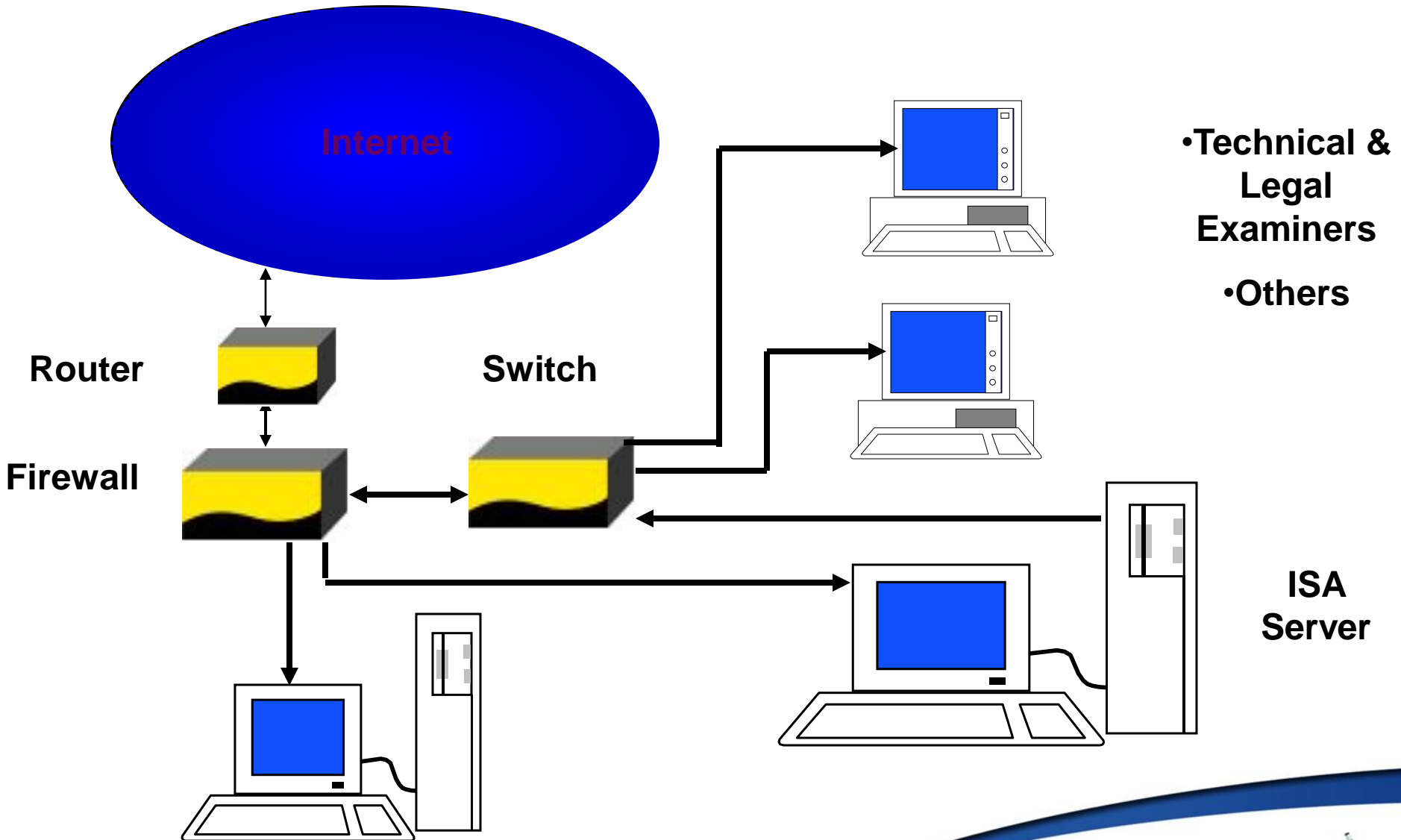

WEB Server



# Egyptian Database

**The database was designed with  
cooperation with WIPO**



# IPAS

World Intellectual Property Organization

User

Password

Login

# WIPOScan ARCHIVING SYSTEM

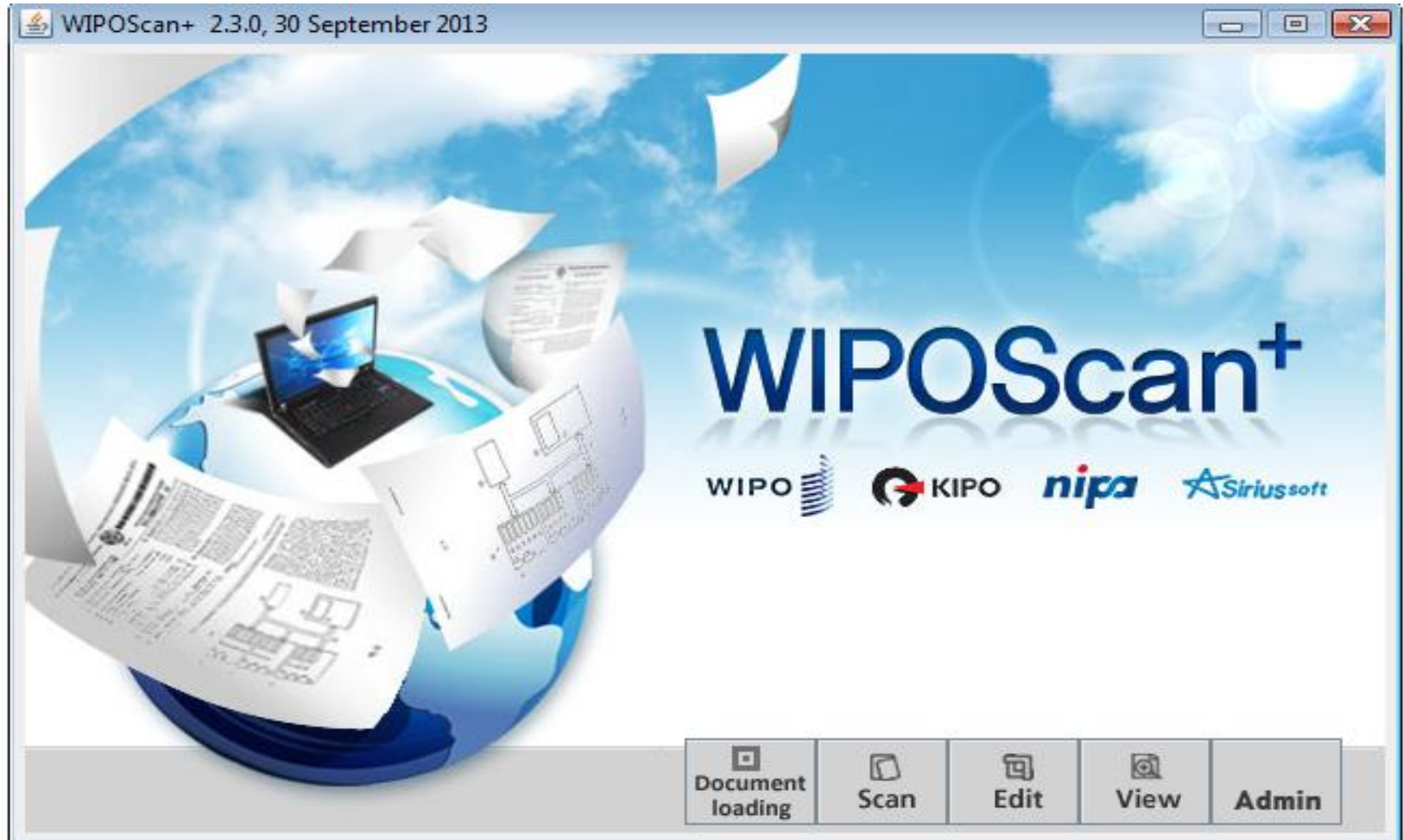



# Home Page

http://www.egypo.gov.eg/

File Edit View Favorites Tools Help

Free Hotmail Suggested Sites Web Slice Gallery

English

الصفحة الرئيسية سؤال وجواب إتصل بنا الأخبار و المعلومات كيفية التقدم القوانين و الإتفاقيات البحث أنشطة و خدمات

البحث عن البراءات الصادرة

تسجيل الإختراعات

تسجيل نماذج المنفعة

تسجيل طلب دولي

الرسوم

وكلاء البراءات في مصر

بيانات الحساب

اسم المستخدم:

كلمة السر:

تذكرني

دخول التسجيل

أخر الأخبار

إحصائيات الزوار

اليوم: 234

الاسبوع الماضي: 3354

الشهر الماضي: 11933

تكريم الحاصلين على الجوائز الذهبية والبرونزية بهتريس جنيف الدولي 2013 من معالي الوزير ورئيس الأكاديمية

تصميم وتنفيذ: م/هيثم محمود الندي

جميع حقوق الطبع محفوظة لمكتب براءات الإختراع المصري © 2013

EN 11:47 ص ٢٠١٥/٠٧/١١



# Development of the Egyptian Patent Office

- The infrastructure;
- The human resources;
- The office procedure.



# The Human Resources

- **Training**
- **Re-allocation of staff according Job Description**
- **Create a new Departments**
- **Increase the No. of Technical Staff 113 examiner**



# Development of the Egyptian Patent Office

- The infrastructure;
- The human resources;
- The office procedure.



# The office procedure.

- **Develop Paper Work Flow**
- **Merge the electronic work flow with the paper work flow**
- **Automation the work flow**



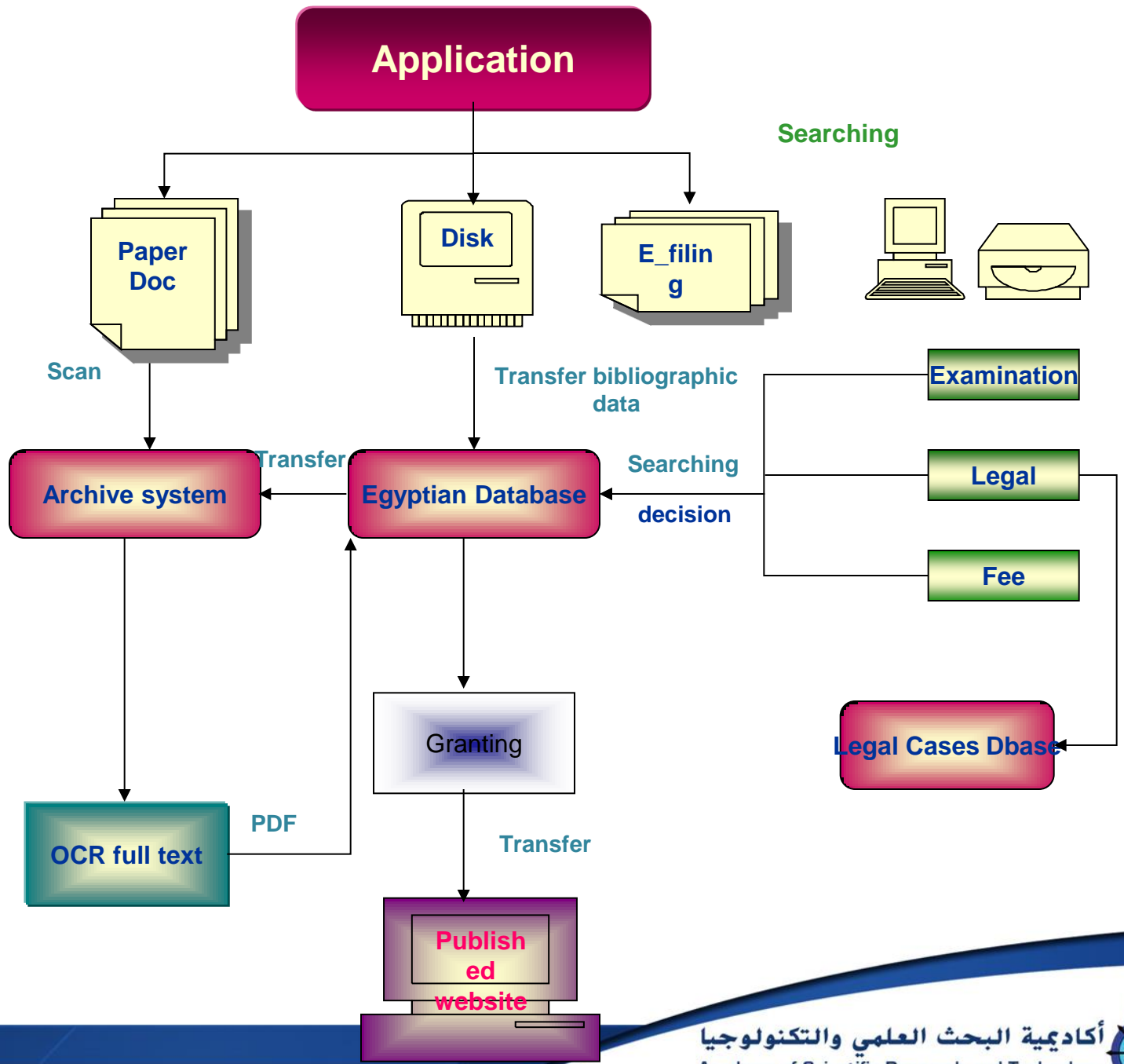

# E-Filing Through Internet

Microsoft Internet Explorer - التسجيل الإلكتروني

File Edit View Favorites Tools Help

Back Forward Stop Refresh Home Search Favorites Media Print Mail Stop

Address <http://195.43.2.114/ipagent/> Go Links Norton AntiVirus

نظام التسجيل الإلكتروني لطلبات براءات الاختراع

هوية المستخدم

كلمة السر

لغة واجهة التطبيق عربي

ارسال تعديل

Done Internet

start التسجيل الإلكتروني - ... Document1 - Microsof... EN 02:09 م

## Patent Attorney and Focal Applications

PATENT SYSTEM - Microsoft Internet Explorer

File Edit View Favorites Tools Help

Back Forward Stop Refresh Home Search Favorites Media Print Mail Links Norton AntiVirus

Address http://195.43.2.114/ipagent/Arb\_site/index\_a.htm Go

### التسجيل

#### الطلبات

⚠️ ⚠️ خانات اتراميه ، يرجى ملؤها الآن

رقم الطلب:

تاريخ الطلب:  /  /

نوع البراءة:

---

#### بيانات المالك

إسم المالك (لاتيني):

النشاط (لاتيني):

عنوان المالك (لاتيني):

عنوان المراسلات (لاتيني):

التسجيل الإلكتروني

- طلبات
- تعديل
- استعلام

Done Internet

start PATENT SYSTEM - Mic... Document1 - Microsof... EN 02:11 م



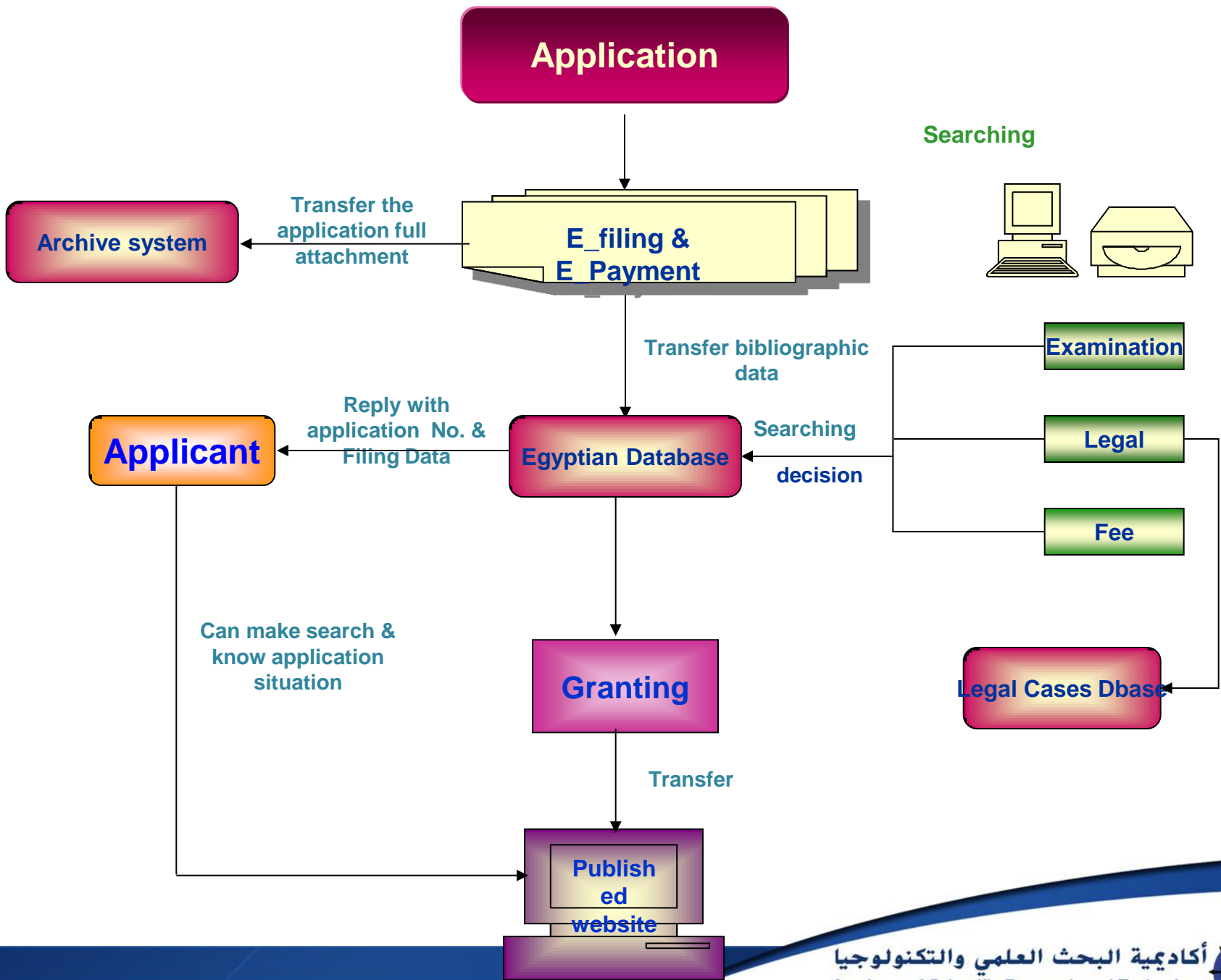

**E-government  
E-filing , e-payment , e-services**

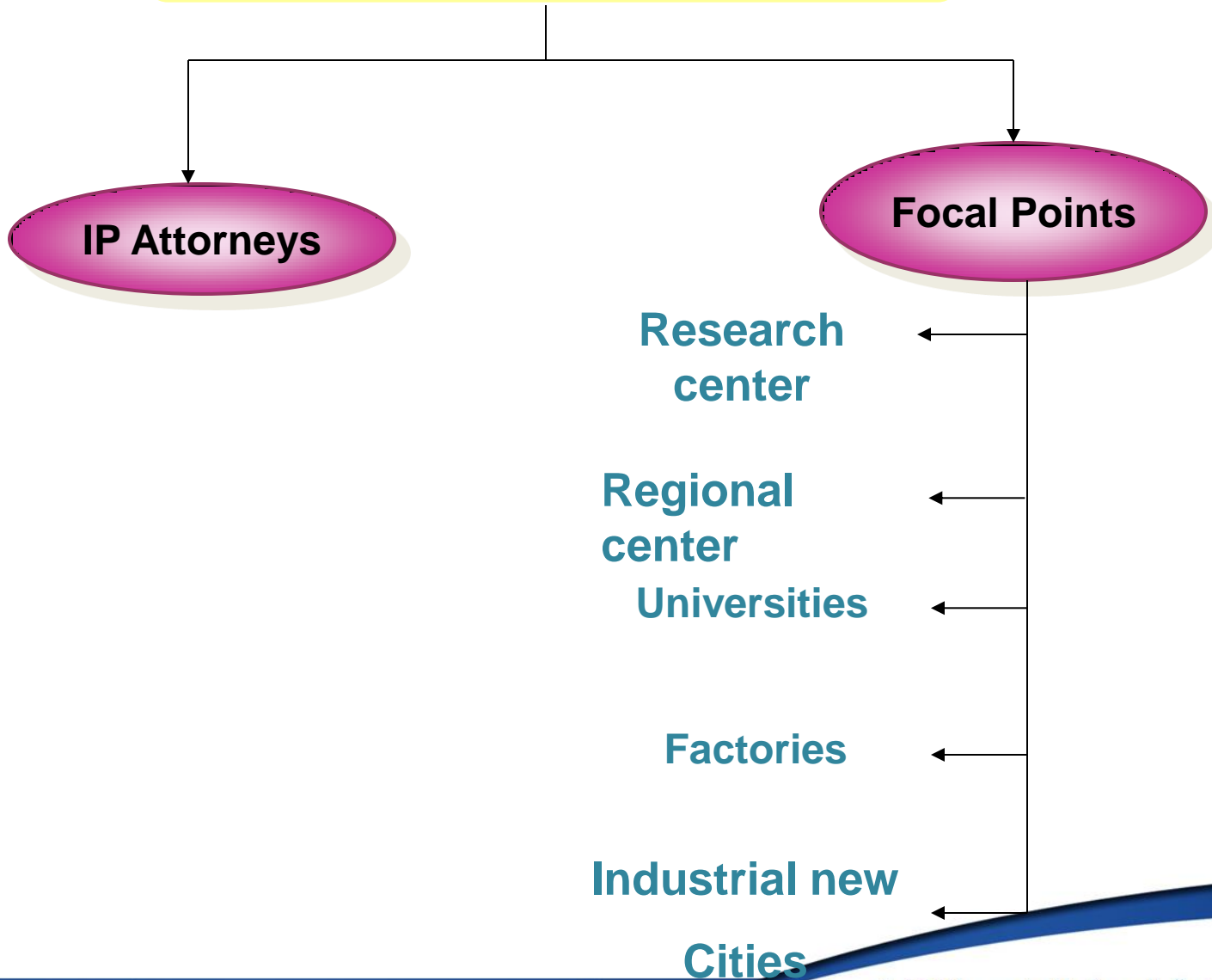

# Modernization of Egyptian Patent Office

Promoting innovation depends on Four factors:

- Legislations (Intellectual Property Law )
- Administration System for Applying the Law
- **Availability of IP information**
- Encourage & Supporting Inventors

# Availability of IP Information

- Web Site ([www.egypo.gov.eg](http://www.egypo.gov.eg))
- Large Patent application collection on paper, Microform, CD, and DVD from EPO, USA, DE, AU, PCT, JP,...etc
- Internet Connection (Online searching using many database)
- Online access to EPOQUE



# إتاحة معلومات الملكية الفكرية



## توفير قواعد البيانات



- **Free database**  
WIPO” PATENTSCOPE®”, EPOline, Espacenet, , USPTO, JPO, SIPO, KIPRIS, SurfIP, Free Patents online and Journals.
- **Private Database**  
EPOQUENET, WPI, STN, PatBase, SCIENCE DIRECT, THE PORTAL, SPRINGERLINK, JOURNAL OF BIOCHEMICAL CHEMISTRY, ACE PUBLICATION, ASCE PUBLICATION, INFORMA.COM, WILLY INTERSCIENCE, IEEE, etc
- **Technical Examiners (Min. 100)**



# Periodical and non-patent Document

- We are connecting to a very large Scientific periodical database through INSTENT
- Egyptian Knowledge Bank



# New Project

- **OCR all EG patent Document**
- **Full-text Searchable**
- **Machine Language translation**



# Modernization of Egyptian Patent Office

**Promoting innovation depends on Four factors:**

- Legislations (Intellectual Property Law )
- Administration System for Applying the Law
- Availability of IP information
- **Encourage & Supporting Inventors**



# Support Innovation and Scientific Research

- **Regional Training Centre**
- **IP Academy**
- **TISC**
- **TTO Office**
- **IP Technical consultation Service**
- **Patent Search**

**Technology Innovation  
Commercialization Office  
(TICO)**

**Grant and International  
Cooperation Office  
(GICO)**

1. Define potential funding opportunities for local and international research projects.
2. Improve opportunities of getting international technical/ financial support for the research
3. Support the researchers who are working in the field of managing and following –up of the research projects.

**Technology Innovation  
Support Center  
(TISC)**

1. Patents and intellectual property.
2. Means of to submit new researches in different fields
3. drafting of patent application
4. Clarify the procedures required to obtain a patent
5. Guide in resolving any technological technical / industrial problem concerning patent applications/ patents issued/ patent fallen in the public property/ ideas of inventors (databases)

**Technology Transfer Office  
(TTO)**

1. actual technological market needs
2. Technology Management
3. technological incubators
4. Quantitative and qualitative evaluation of the technology
5. Patents and marketing of innovative ideas
6. license the use of technologies



# Technology Innovation Commercialization Office(TICO)

- NO. of TICO 33 office
- Budget 20 Million EGP
- **Key Partners**
- Universities
- Research centers
- Research & Development (R&D) centers in industrial zones
- Production firms and development sectors in both government and private sectors
- Excellence centers



# TICO Offices

	Agency	The total value of contract
1	Ministry of Industry and Foreign Trade Industry Council for Technology and Innovation	700.000
2	Kafrelsheikh University	-
3	Ain Shams University	700.000
4	Arab Academy for Science ,Technology & Maritime Transport	700.000
5	Suez Canal University	700.000
6	Heliopolis University	698860
7	Tanta University	700.000
8	The Agricultural Research Center	653410
9	Assiut University	700.000
10	Minia University	699776
11	Suez University	700.000
12	Alexandria University	-
13	October 6 University	400.000
14	Mansoura University	600.000
15	The National Research Centre	700.000
16	Egypt-Japan University of Science and Technology	650.000
17	The south Valley University	700.000
18	Helwan University	700.000
19	Tabbin Institute for Metallurgical Studies (TIMS)	560.000
20	The American University in Cairo	700.000
21	Cairo University	640.000
22	Nile University	699773
23	Electronics Research Institute	700.000
24	Zagazig University	681.000
25	Syndicate of Scientific Professions - Cairo	-
26	Syndicate of Scientific Professions - 6 <sup>th</sup> October	-
27	Al-Azhar University	700.000
28	Housing & Building Research Center (HBRC)	600.000
29	Minoufiya University	-
30	The Industrial Development Authority	-
31	Chamber of Information Technology and Communications Industry Federation of Egyptian Industries	-
32	The Central Metallurgical Research and Development Institute (CMRDDI)	700.000
33	The National Authority for Remote sensing and Space Science (NARSS)	700.000
34	October University for Modern Science and Arts	-
35	Industrial Modernization Centre	700.000
36	The Egyptian Atomic Energy Authority (EAEA)	700.000
37	Science and Technology Centre for Excellence	700.000
	Total	19650419



# Supporting Master & PHD project

- SPECIFY FIELD (Priorities of Industry – Solve Technical Problem – Government Policy)(energy – water – health)
- SME's
- 12 Million EGP – 6.8 Million EGP



# Egyptian Young Academy of Science (EYAS)



[www.globalyoungacademy.net](http://www.globalyoungacademy.net)  
<http://www.diejungeakademie.de/home>  
<http://www.bbaw.de/en/agya/concept>

- **Mission**

Creation of an enabling and encouraging environment for young scientists in Egypt's STI system as the main pillar of a knowledge-based economy..

- **Objectives :**

To create an enabling environment for young scientists,

To promote networking among young scientists,  
To guide talented young researchers for worldwide scholarships, grants, and prizes.

To build bridges with Egyptian expat scientists,  
To encourage interdisciplinary research teams,

To qualify young researchers to actively participate in the formulation of national STI strategies, foresights and roadmaps,

To promote the value of science, innovation, invention and scientific thinking and culture in the society.



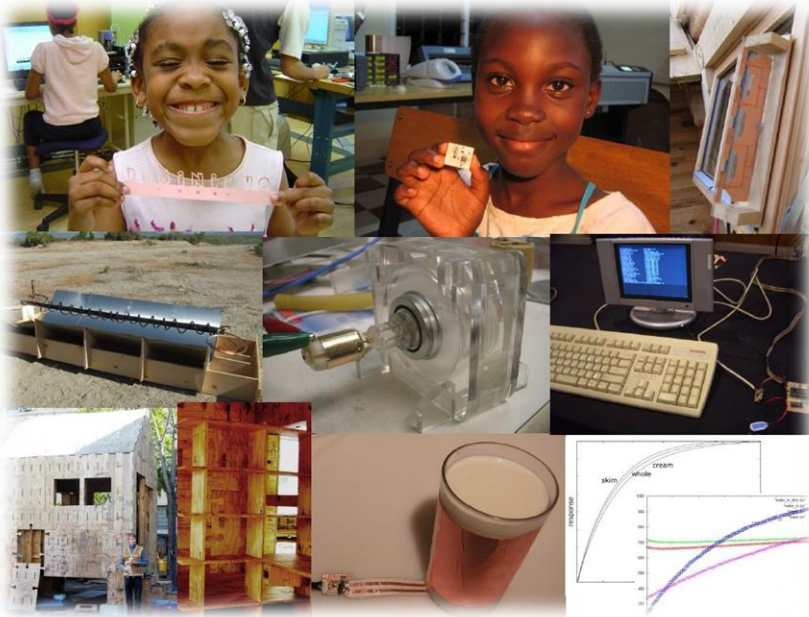

# School student Innovation “FAB-LAB”



# National Program for Technological Specialized Incubators “INTILAC”



- Academy of Scientific Research and Technology (ASRT) works to bridge the gap between Academic Researchers, professionals and business community by transferring innovative technological ideas,
- Seed fund up to 150,000 L.E
- Incubation/Acceleration
- Hands-on Training
- Prototype Financing
- Technology Validation
- Technical & Advisory Support
- Networking with Ecosystem
- Seed Funding for Technology Commercialization





# EG-KTAs: Egypt Knowledge and Technology Alliances



- E- KTAs is a cluster of partners working across the innovation chain, focusing on the national industrial sector(s) where the main innovation actors are positioned in the driving seat for an effective technology development. In this context, E- KTAs aims to pool and network national competences in universities, research organizations, NGOs and industry to drive innovation and technology transfer for solving national pressing problems.



# Cairo International Exhibition of Innovation



معرض القاهرة الدولي  
الثالث للإبتكار  
3<sup>rd</sup> Cairo International  
Exhibition of Innovation  
**2016**  
في الفترة من ١٩ إلى ٢٠ نوفمبر ٢٠١٦



Misr El-Kheir orange République Française Schneider Electric giz cleantech EUROPEAN UNION EDUCATION Ticketsmarche.com



# www.egypo.gov.eg

الصفحة الرئيسية - مكتب

www.egypo.gov.eg

EGYPTIAN PATENT OFFICE  
مكتب براءات الاختراع المصري

أكاديمية البحث العلمي  
مكتب براءات الاختراع

English

الصفحة الرئيسية سؤال وجواب إتصل بنا الأخبار والمعلومات كيفية التقدم القوانين والإقافيات البحث أنشطة وخدمات

البحث عن البراءات الصادرة  
تسجيل الإختراعات  
تسجيل نماذج المنفعة  
تسجيل طلب دولي  
الرسوم  
وكلاء البراءات في مصر

بيانات الحساب

اسم المستخدم:  
كلمة السر:  
تذكرني   
دخول التسجيل

آخر الأخبار

أحمد محمد النبي  
رئيس مشروع TICO  
م/ أحمد طنبة  
نائب رئيس مشروع TICO  
م/ عادل السعيد عوضة  
رئيس مكتب براءات الاختراع  
ذلك يوم الأربعاء الموافق  
18/06/2014

تكريم الفائزين بمعرض جنيف الدولي



Windows e File Explorer Chrome S

7:59 PM  
11/5/2014



# Encourage & Supporting Inventors

- Invention and Innovation Development Agency
- Prizes Department (ASRT)  
Invention And Innovation Prize
- Technology Innovation Commercialization Office (TICO)



# EGPO Important Statistic



## Patent applications in Egyptian patent office From 2010 to 2017

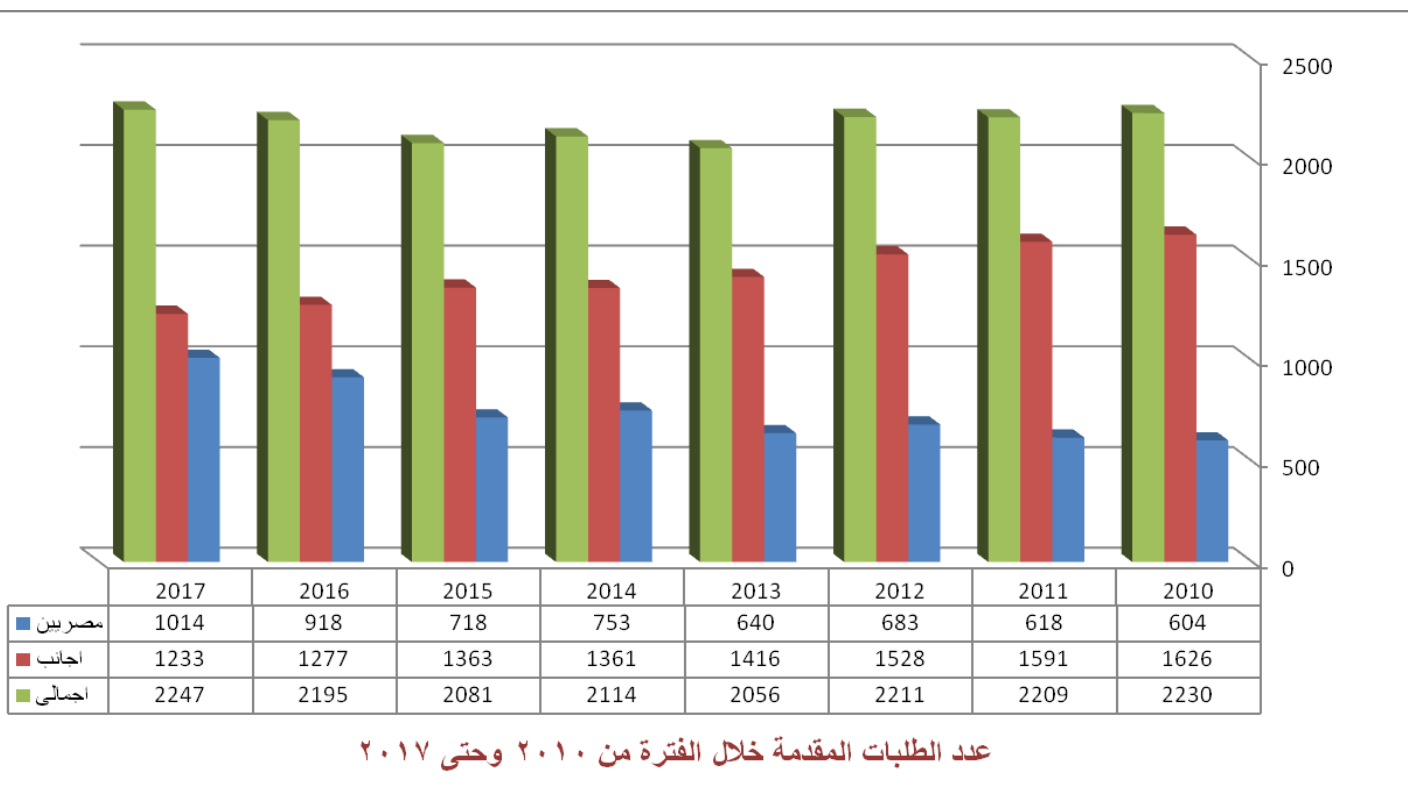

# Granted patents from Egyptian patent office

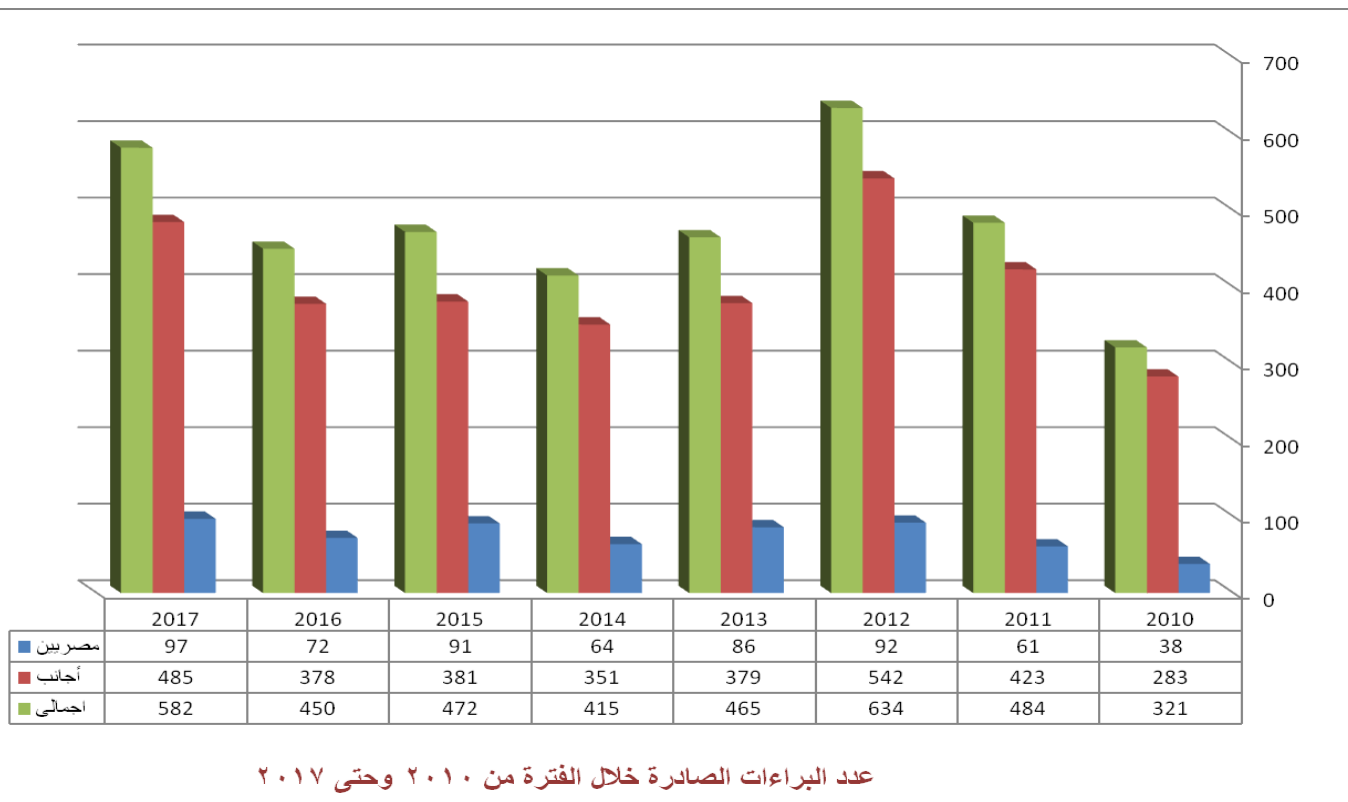

# International Patent application (PCT) Search & Examination Authority

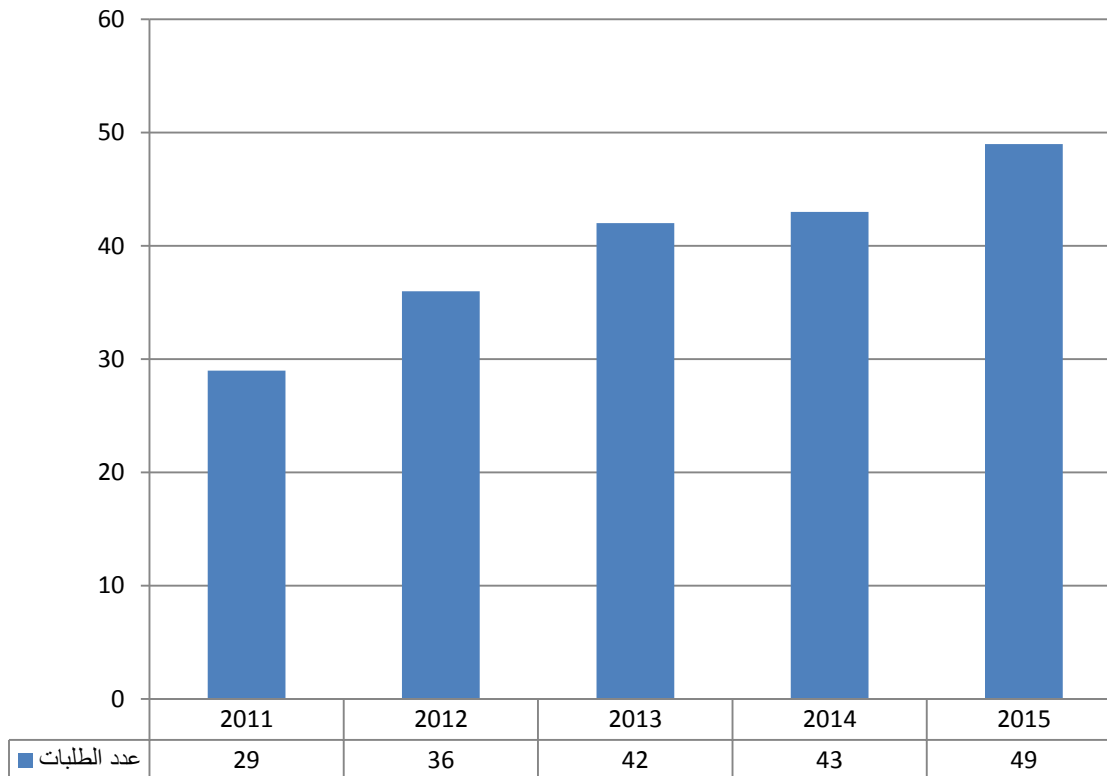



# International Cooperation

## 1- Cooperation with WIPO

- Effective of the MOU for Establishment of a Regional Training Center for Patent
- Cooperation with WIPO Worldwide Academy
- Support the Egyptian Patent Office
- Cooperation for the Promotion of Technology Transfer



# International Cooperation

## 2- Cooperation with EPO

The Egyptian Patent Office agreed with the EPO for cooperation in the following area:

- Exchange of data
- Arabpat
- IP personal Training
- Promote public awareness of IP



# International Cooperation

3- Cooperation with the State Intellectual property Office of China (SIPO) for the purpose of bilateral cooperation and communication for the following:

- Exchange views and issues of IP
- IP personal Training
- Exchange views on promoting public awareness of IP and disseminating IP knowledge

4- Cooperation with JPO ( Mou for PPH)



# Thank You !



[www.egypo.gov.eg](http://www.egypo.gov.eg)  
[patinfo@egypo.gov.eg](mailto:patinfo@egypo.gov.eg)

Tel: +202 27921272      +202 27921291

Fax: +202 27921272

أكاديمية البحث العلمي والتكنولوجيا  
Academy of Scientific Research and Technology

