APPENDIX I

EXAMPLES OF INDUSTRIAL DESIGNS FROM THE
"INTERNATIONAL DESIGNS BULLETIN" /
"BULLETIN DES DESSINS ET MODELES INTERNATIONAUX"

Dépôts publiés selon l'Acte de 1960 / Deposits Published Under the 1960 Act

(11) DM/060 694 (15) 15.04.2002

(73) MAYERHANSER GEORG, Schleissheimerstrasse 82 C, D-85221 DACHAU (DE) – (86)(87)(88) DE – (28) 1 –
(54) Sculpture / Sculpture – (51) Cl. 11-02 – (81) I. BG, BX, CH, FR, GR, HU, IT, KP, LI, MA, MC, RO, SI, YU. II. AN, EG,
ES, ID, TN, VA. – (30) 18.10.2001, No 401 09 545.2, DE

1

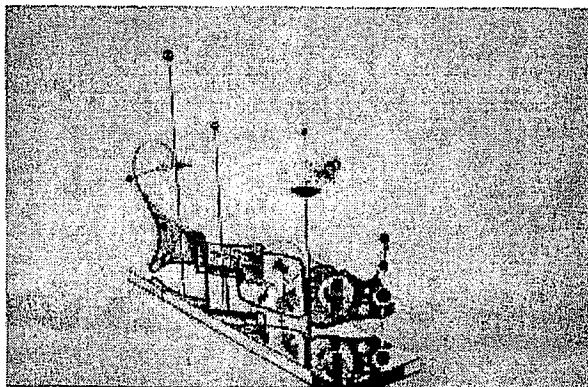

Dépôts publiés selon l'Acte de 1960 / Deposits Published Under the 1960 Act

(11) DM/060 545 (15) 21.08.2001

(73) HERNER GLAS BERND HOFFBAUER GMBH & CO, Leuchten und Industrieglas KG Am Trimbuschhof 16-18, D-44628 Herne (DE) - (86)(87)(88) DE - (74) Patentanwälte Ostriga, Sonnet & Wirths, Stresemannstr. 6-8, D-42275 Wuppertal (DE) - (28) 45 - (54) Lamp glasses / Verres de lampes - (51) Cl. 26-05 - (81) I. BX, CH, DE, FR, IT, MA. II. AN, EG, ES, ID, TN, VA - (46) 21.08.2002

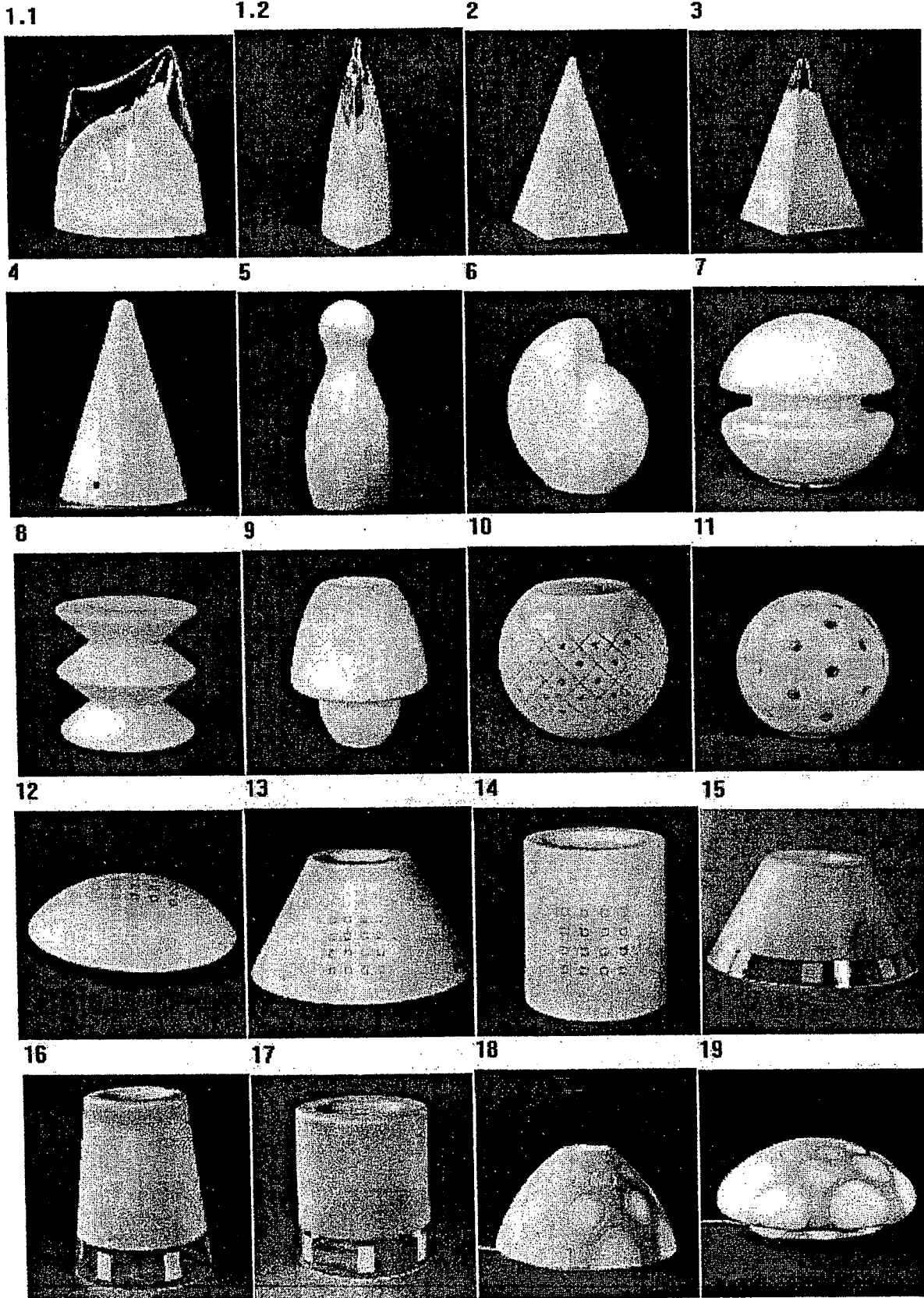

Dépôts publiés selon l'Acte de 1960 / Deposits Published Under the 1960 Act

(11) DM/060 765 (15) 03.06.2002

(73) VAN CLEEF & ARPELS LOGISTICS S.A., 8, route de Chandolan, CH-1752 VILLARS-SUR-GLÂNE (CH) – (86)(87) CH (88) n/a – (74) Berkeley Intellectual Property Services (Knightsbridge) Limited, 27 Knightsbridge, LONDON SW1X 7YB (GB) – (28) 33 – (54) Jewellery *Joaillerie* – (51) Cl. 11-01 – (81) I. BX, CH, DE, FR, GR, IT, LI, MC. II. AN, EG, ES, ID, TN, VA

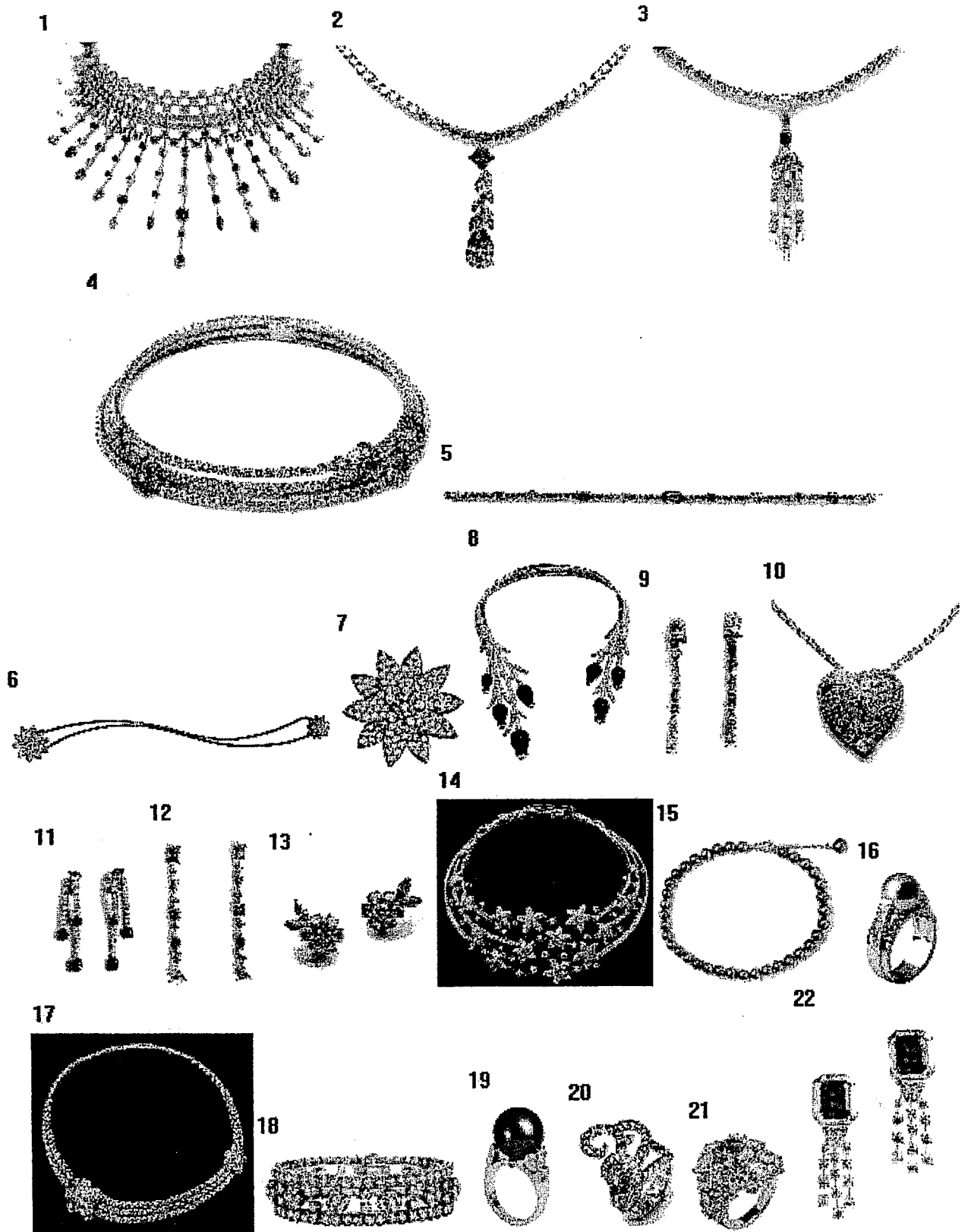

Dépôts publiés selon l'Acte de 1960 / Deposits Published Under the 1960 Act

(11) DM/060 448 (15) 02.04.2002

(73) CHAUMET INTERNATIONAL S.A., 12, place Vendôme, F-75001 Paris (FR) – (86)(87)(88) FR – (74) Griffes Consulting S.A., 81, route de Florissant, CH-1206 Genève (CH) – (28) 20 – (54) Rings, bracelets, pendants, earrings / *Bagues, bracelets, pendentifs, boucles d'oreilles* – (51) Cl. 11-01 – (81) I. BX, CH, DE, FR, GR, IT, LI, MA, MC. II. AN, EG, ES, ID, TN, VA

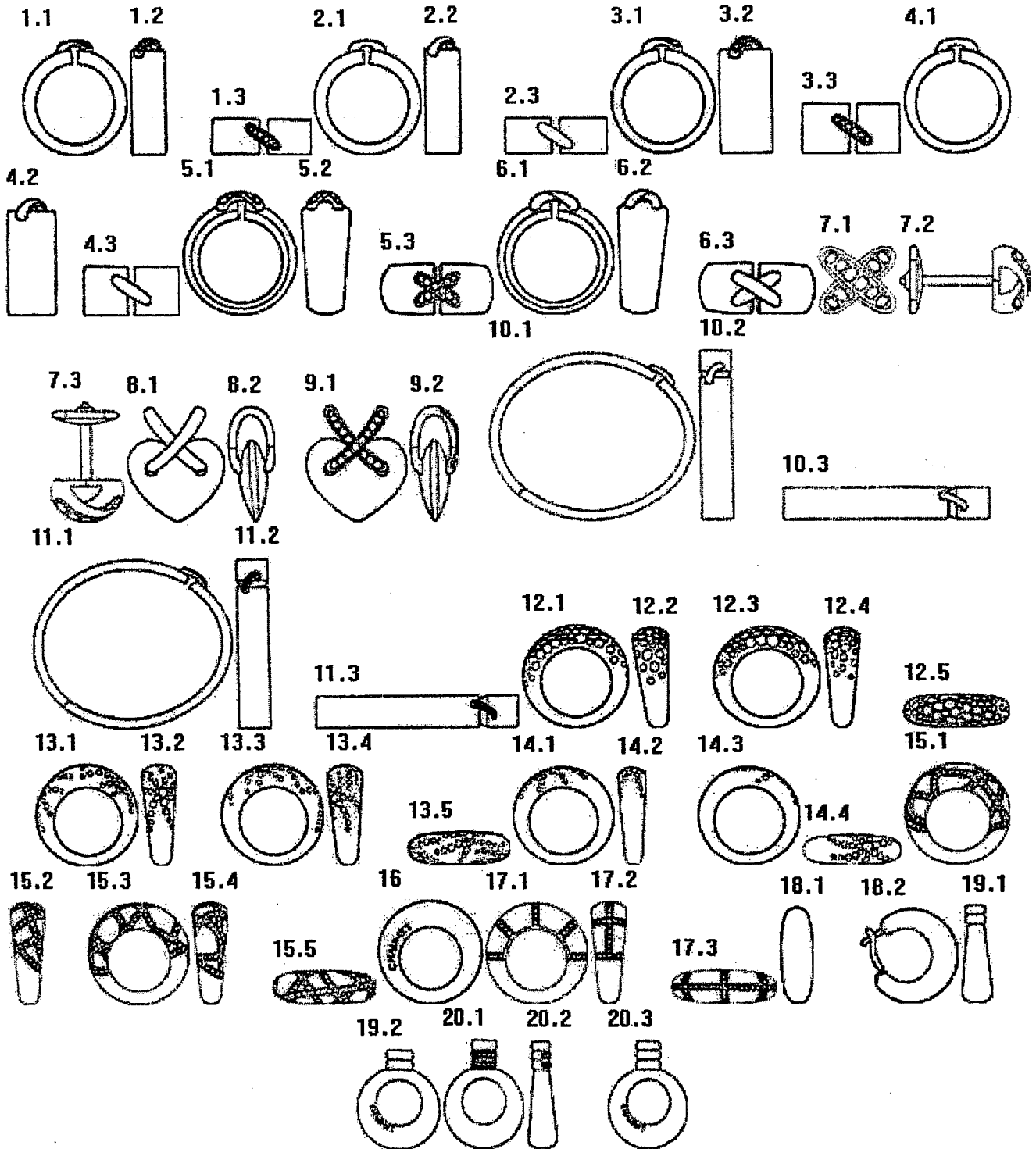

Dépôts publiés selon l'Acte de 1960 / Deposits Published Under the 1960 Act

(11) DM/060 562 (15) 24.05.2002

(73) SOCIÉTÉ ANONYME DE LA MANUFACTURE D'HORLOGERIE AUDEMARS, PIGUET & CIE, CH-1348 LE BRASSUS (CH) – (86)(87)(88) CH – (74) BUGNION S.A., Case postale 375, CH-1211 GENEVE 12 (CH) – (28) 2 – (54) Montre, boîte de montres / Watch, watch case – (51) Cl. 10-02, 07 – (81) I. CH, DE, FR, IT. II. AN, EG, ES, ID, TN, VA

1

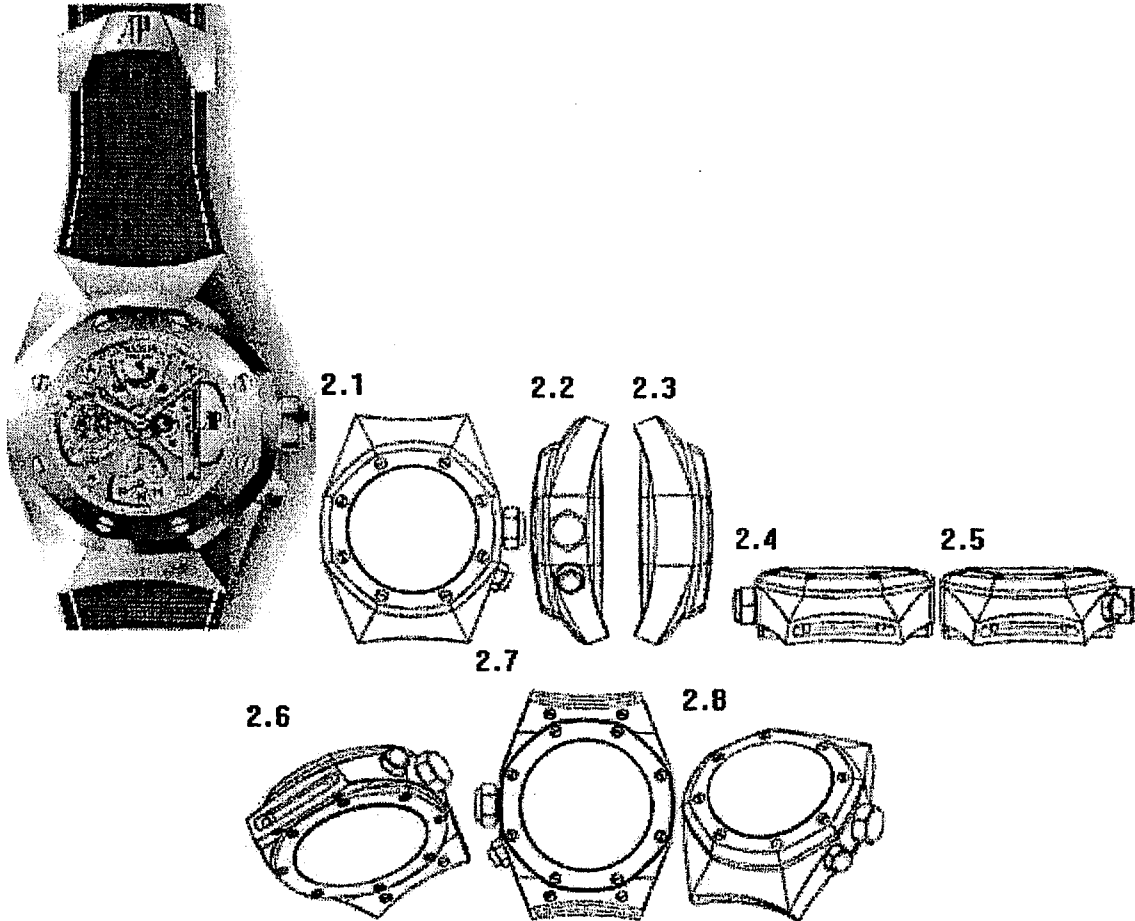

Dépôts publiés selon l'Acte de 1960 / Deposits Published Under the 1960 Act

(11) DM/060 591 (15) 08.07.2002

(73) UVEX ARBEITSSCHUTZ GMBH, 189, Würzburger Strasse, D-90766 Fürth (DE) – (86)(87)(88) DE – (74) Rau, Manfred, Dr. Dipl.-Ing. Schneck, Herbert, Dr., Dipl.-Phys., Hübner, Gerd, Dipl.-Phys.-Rau, Albrecht, Dr., Dipl.- Phys., Patentanwälte, 2, Königstrasse, D-90402 Nürnberg (DE) – (28) 1 – (54) Industrial safety glasses / *Lunettes de protection à usage industriel* – (51) Cl. 16-06 – (81) I. BX, CH, FR, HU, IT. II. AN, EG, ES, ID, TN, VA. – (30) 25.01.2002, No 402 00 606.2, DE

1.1

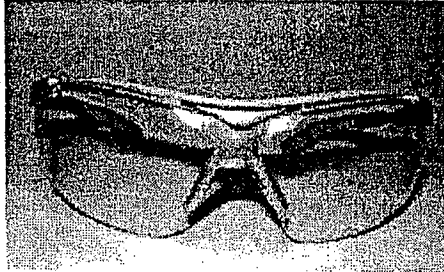

1.2

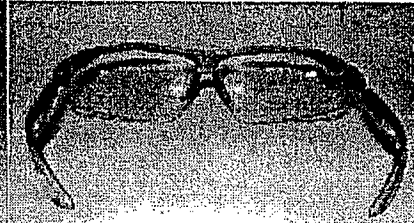

Dépôts publiés selon l'Acte de 1960 / Deposits Published Under the 1960 Act

(11) DM/060 547 (15) 24.08.2001

(73) TOD'S S.P.A., 1, via Filippo Della Valle, I-63019 Sant'Elpidio a Mare (AP) (IT) – (86)(87)(88) IT – (74) Jacobacci & Partners S.p.A., Corso Regio Parco, 27, I-10152 Torino (IT) – (72) Gualberto POLLASTRELLI – (28) 3 – (54) Shoes, footwear sole / Chaussures, semelle – (51) Cl. 02-04 – (81) I. BG, BX, CH, DE, FR, GR, HU, IT, LI, MC, MK, RO, SI – (46) 24.08.2002

1.1

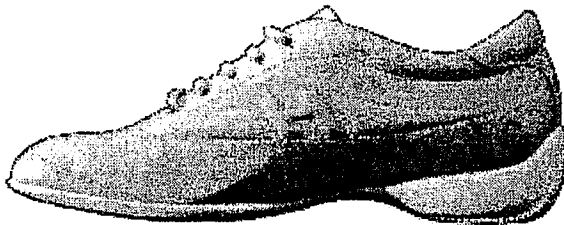

1.2

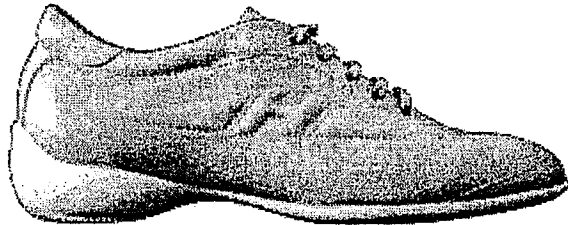

1.3

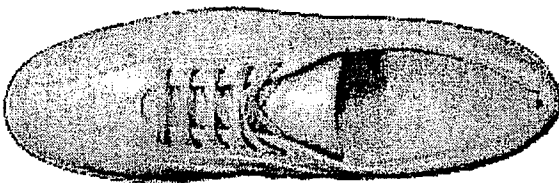

1.4

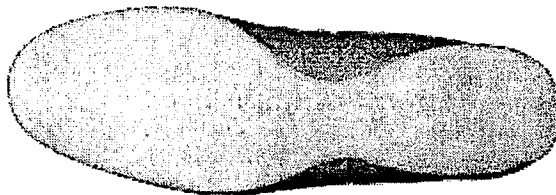

1.5

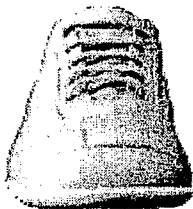

1.6



2.1

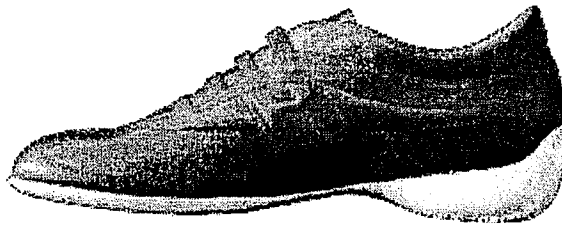

2.2

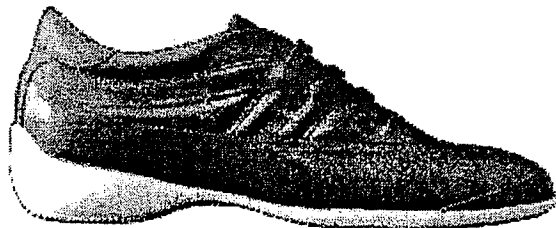

2.3

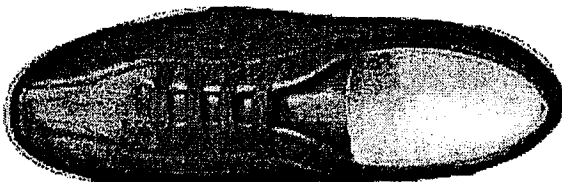

2.4

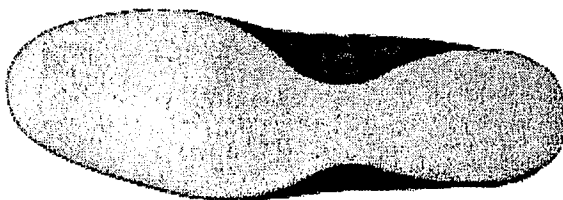

2.5



2.6



3.1



3.2



Dépôts publiés selon l'Acte de 1960 / Deposits Published Under the 1960 Act

(11) DM/060 534 (15) 03.04.2002

(73) "FRAGOS SOCIETY ANONYMOUS OF PRODUCTION AND TRADE OF GARMENTS", 423B, Voullagmenis AV, 163 46, Ilioupoli, ATHENS (GR) – (86)(87)(88) GR – (74) ARSINOI, MOUSAKI, LAWYER, 57, Stadiou Street, GR-10551 ATHENS (GR) – (72) ANASTASIA SKLAVOLIA – (28) 3 – (54) Children's garment sets of three pieces *Ensembles de vêtements pour enfants à trois pièces* – (51) Cl. 02-02 – (57) Children's garment sets consisting of three pieces, packed in one single packaging. Each set includes a children's dress, or a baby overall or rompers suit where the upper part is separable from the lower part thereby forming two separate pieces and two or three different pieces *Ensembles de vêtements pour enfants se composant de trois pièces, conditionnés dans un seul emballage. Dans chaque ensemble, comprenant une robe d'enfant, ou encore une combinaison ou barboteuse pour bébé, la partie supérieure peut être séparée de la partie inférieure et former ainsi deux pièces séparées ou encore deux ou trois pièces distinctes* – (81) I. BG, BJ, BX, CH, DE, FR, HU, IT, KP, MC, MD, MK, RO, SI, YU. – (30) 05.10.2001, No 20010600222, GR



Dépôts publiés selon l'Acte de 1960 / Deposits Published Under the 1960 Act

(11) DM/060 566 (15) 26.02.2002

(73) PARFUMS CARON (SOCIÉTÉ ANONYME), 99, rue du Faubourg Saint-Honoré, F-75008 PARIS (FR) –
(86)(87)(88) FR – (74) NOVAMARK, 122, rue Edouard Vaillant, F-92593 LEVALLOIS-PERRET Cedex (FR) – (28) 1 –
(54) Flacon pour parfum / *Small bottle for perfume* – (51) Cl. 09-01 – (81) I. BX, CH, DE, IT. II. AN, EG, ES, ID, TN, VA. –
(30) 29.08.2001, No 01 5026, FR

1.1

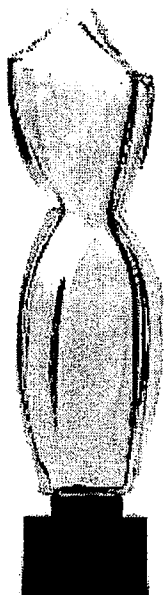

1.2



1.3

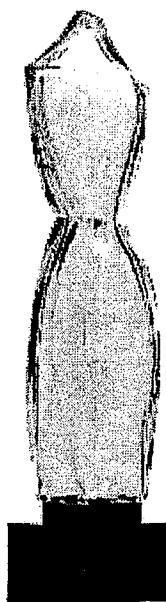

Dépôts publiés selon l'Acte de 1960 / Deposits Published Under the 1960 Act

(11) DM/060 480 (15) 01.07.2002

(73) ACQUA MINERALE S. BENEDETTO S.P.A., 65, Viale Kennedy, I-30037 SCORZE' (Venezia) (IT) – (86)(87)(88) IT –
(74) MODIANO & ASSOCIATI, Via Meravigli, 16, I-20123 MILANO (IT) – (28) 1 – (54) Bouteille *Bottle* – (51) Cl. 09-01 –
(81) I. BX, DE, FR, HU. – (30) 09.01.2002, No PD20020000009, IT

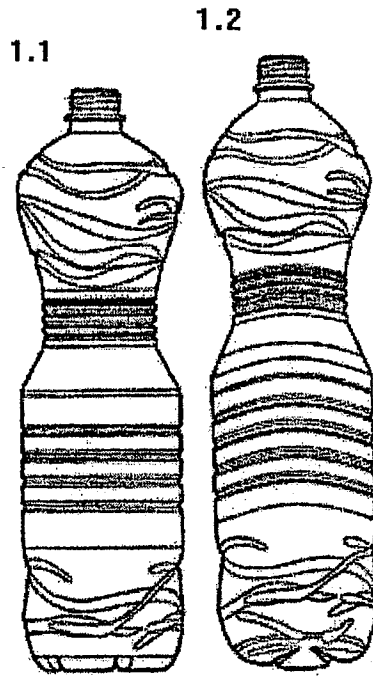

Dépôts publiés selon l'Acte de 1960 / Deposits Published Under the 1960 Act

(11) DM/060 560 (15) 25.02.2002

(73) JEYES DEUTSCHLAND GMBH, 33b, Anna-von-Philipp-Strasse, D-86633 Neuburg (DE) – (86)(87)(88) DE – (74) Luckhurst, Anthony Henry William Marks & Clerk, 57-60 Lincoln's Inn Fields, WC2A 3LS London (GB) – (72) WOOLLEY, Jack Francis, EDGERLEY, David Anthony – (28) 3 – (54) Dispenser for lavatory cleansing composition, refill unit, bottle / *Distributeur de composition de nettoyage de locaux sanitaires, recharge, bouteille* – (51) Cl. 28-99 – (81) I. BG, BJ, BX, CH, CI, DE, FR, GR, HU, IT, KP, LI, MA, MC, MD, MK, MN, RO, SI, SN, SR, YU. II. AN, EG, ES, ID, TN, VA. – (30) 23.08.2001, Nos 2104288, 2104289, GB – (46) 23.08.2002

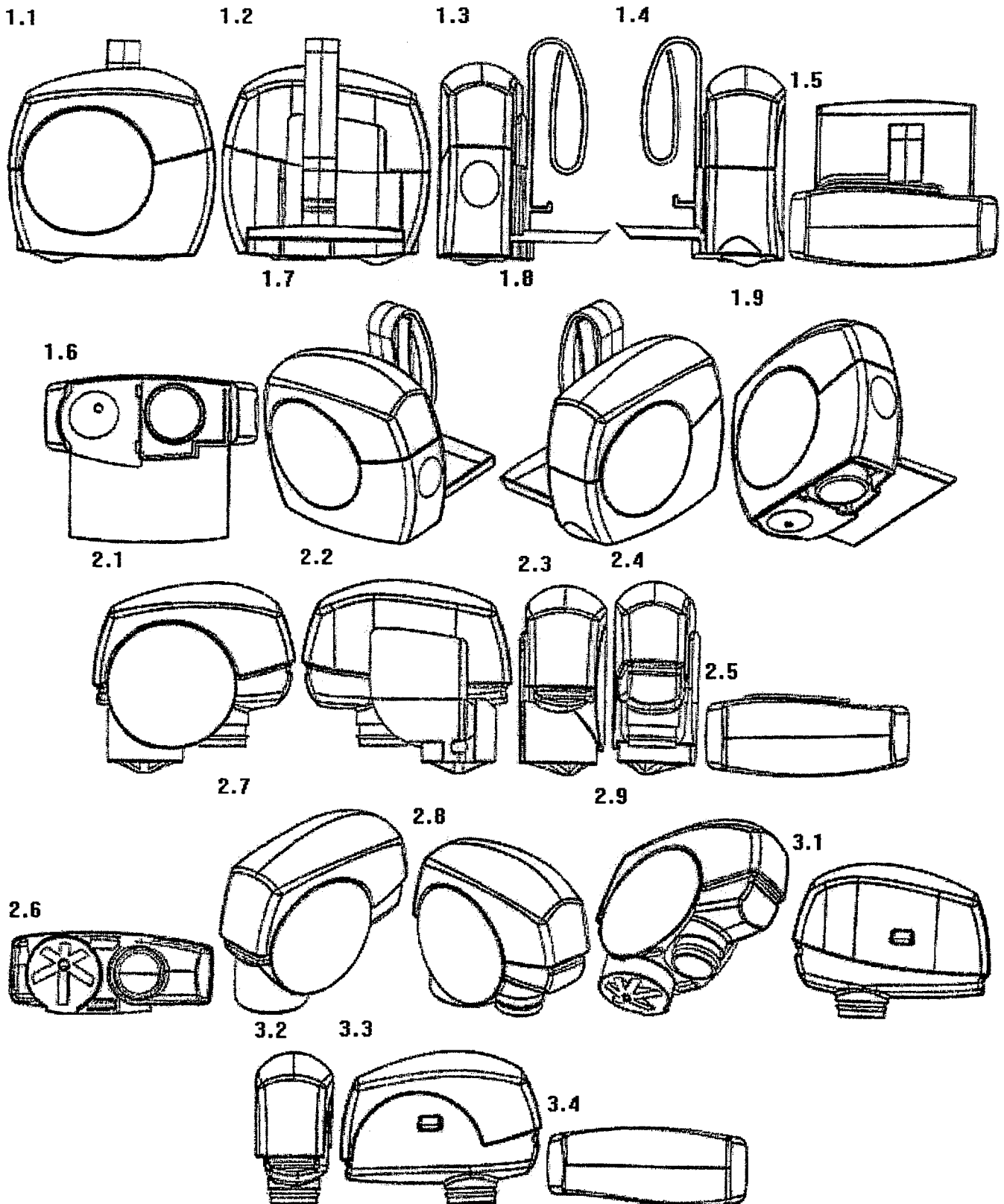

Dépôts publiés selon l'Acte de 1960 / Deposits Published Under the 1960 Act

(11) DM/060 618 (15) 11.07.2002

(73) HÜRLIMANN WERNER, Liebeggasse 15, CH-8708 MÄNNEDORF (CH) – (86)(87) CH (88) n/a – (28) 1 – (54) Fauteuil / *Armchair* – (51) Cl. 06-01 – (57) Fauteuil en bois / *Wooden armchair* – (81) I. BX, DE, FR, IT. – (30) 22.01.2002, No 128487, CH

1.1

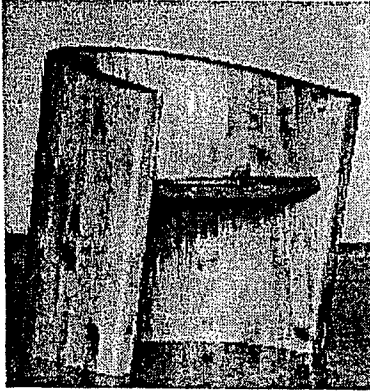

1.2

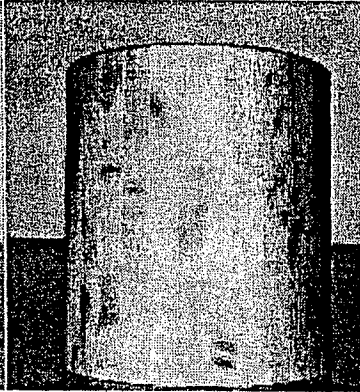

1.3

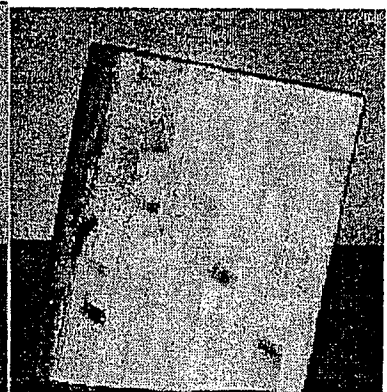

1.4

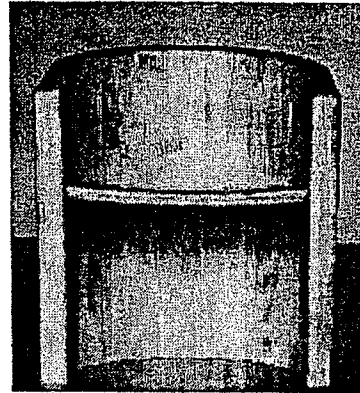

Dépôts publiés selon l'Acte de 1960 / Deposits Published Under the 1960 Act

(11) DM/060 503 (15) 23.05.2002

(73) DAUPHIN ENTWICKLUNGS- U. BETEILIGUNGS-GMBH, 8, Erkelsdorfer Strasse, D-92259 Neukirchen (DE) – (86)(87)(88) DE – (74) Rau, Manfred, Dr. Dipl.-Ing., Schneck, Herbert, Dr. Dipl.-Phys., Hübner, Gerd., Dipl.-Phys., Rau, Albrecht, Dr. Dipl.-Phys., Patentanwälte, 2, Königstrasse, D-90402 Nürnberg (DE) – (28) 26 – (54) Office chairs /Chaises de bureau – (51) Cl. 06-01 – (81) I. BX, CH, DE, FR, IT. II. AN, EG, ES, ID, TN, VA

1.1

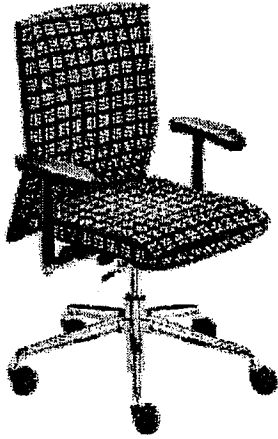

1.2

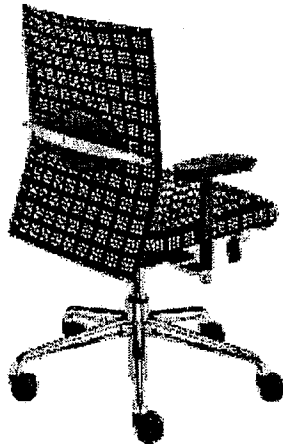

2.1

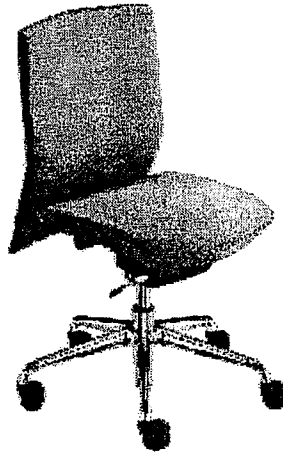

2.2

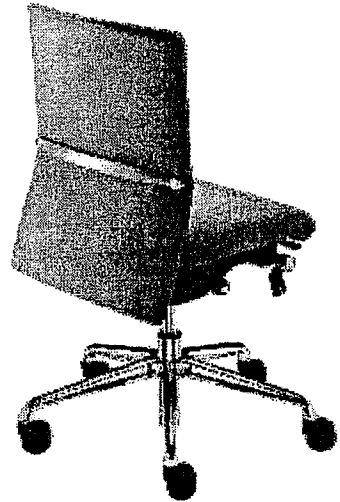

3.2

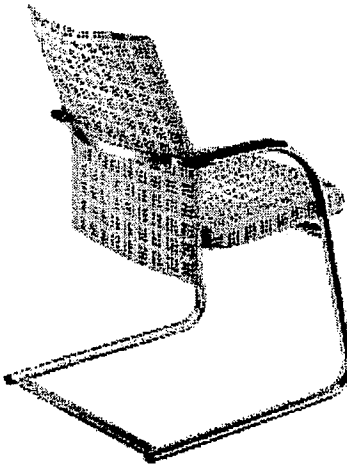

4.1

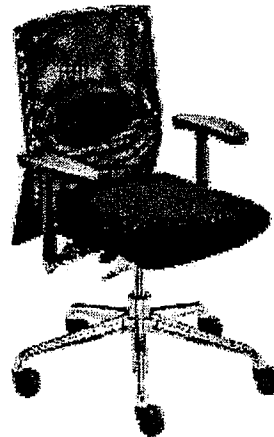

4.2

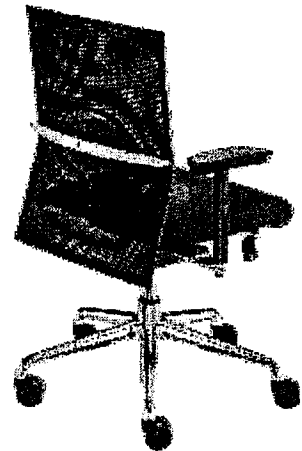

3.1

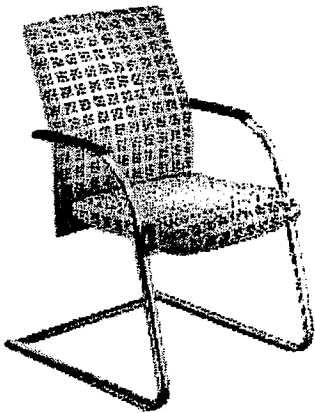

6.1

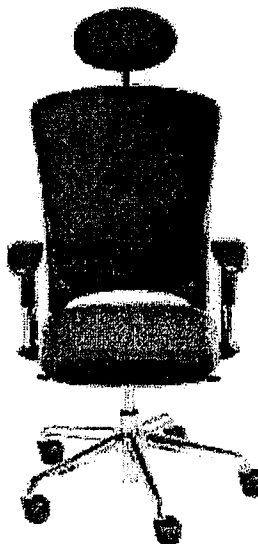

6.2

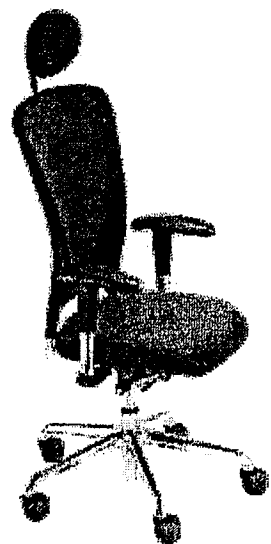

5.1



5.2

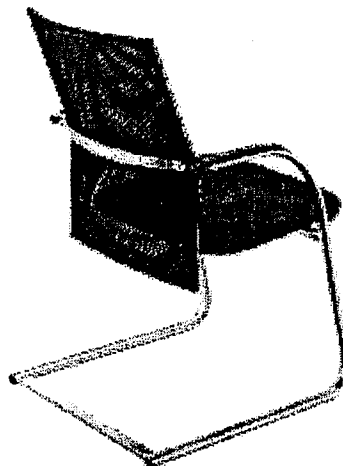

Dépôts publiés selon l'Acte de 1960 / Deposits Published Under the 1960 Act

(11) DM/060 515 (15) 01.07.2002

(73) LEOLUX MEUBELFABRIEK BV, Kazernestraat, 15, NL-5928 NL Venlo (NL) – (86)(87)(88) NL – (72) Axel Enthoven; Frans Schrofer – (28) 2 – (54) Seats / Sièges – (51) Cl. 06-01 – (81) I. BX, CH, DE, FR, GR, HU, IT, KP, LI, MA, MK, SI, SR, YU

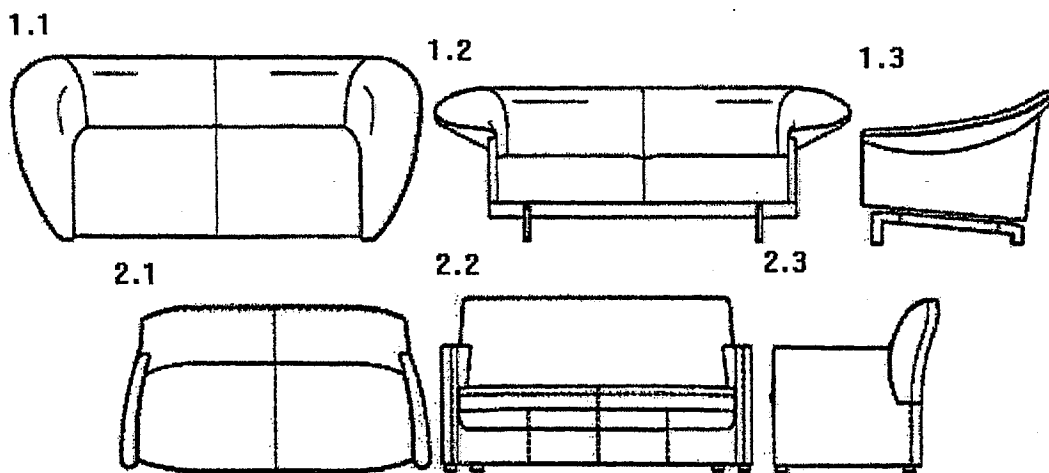

Dépôts publiés selon l'Acte de 1960 / Deposits Published Under the 1960 Act

(11) DM/060 564 (15) 21.02.2002

(73) ANTHEA, 20, Petite Rue, B.P. 6, F-55320 ANCEMONT (FR) – (86)(87)(88) FR – (28) 4 – (54) Meubles, à savoir: table de nuit, armoires, meuble à tiroirs / *Furniture, namely: bedside table, wardrobes, chest of drawers* – (51) Cl. 06-03, 04 – (81) I. BX, CH, DE, GR, IT, LI, MK, RO, YU. II. AN, ES

1

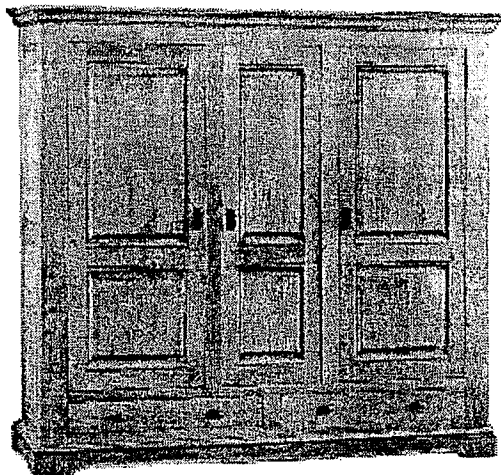

2

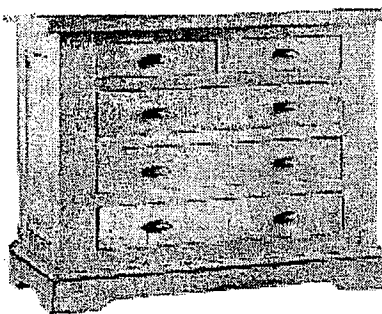

3

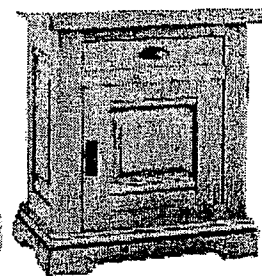

4

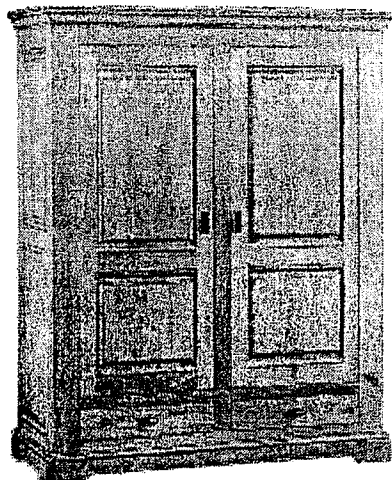

Dépôts publiés selon l'Acte de 1960 / Deposits Published Under the 1960 Act

(11) DM/060 624 (15) 07.06.2002

(73) GRIFFNERHAUS DEUTSCHLAND GMBH, 39, Industriestraße, D-56218 Mülheim-Kärlich (DE) – (86)(87) DE (88) n/a – (74) Patentanwälte BEER Manfred, Dipl.-Ing. HEHENBERGER Reinhard, Dipl.-Ing., 8, Lindengasse, A-1070 Wien (AT) – (72) JANDL, Adolf – (28) 68 – (54) Houses; balcony; canopy; awning; trellis; carport; garage *Maisons; balcon; auvent; vélum; treillis; abri à voiture; garage* – (51) Cl. 25-02, 03 – (81) I. CH, DE, FR, IT. II. AN, EG, ES, ID, TN, VA. – (30) 20.12.2001, No MU 4540/2001-MU 4607/2001, AT

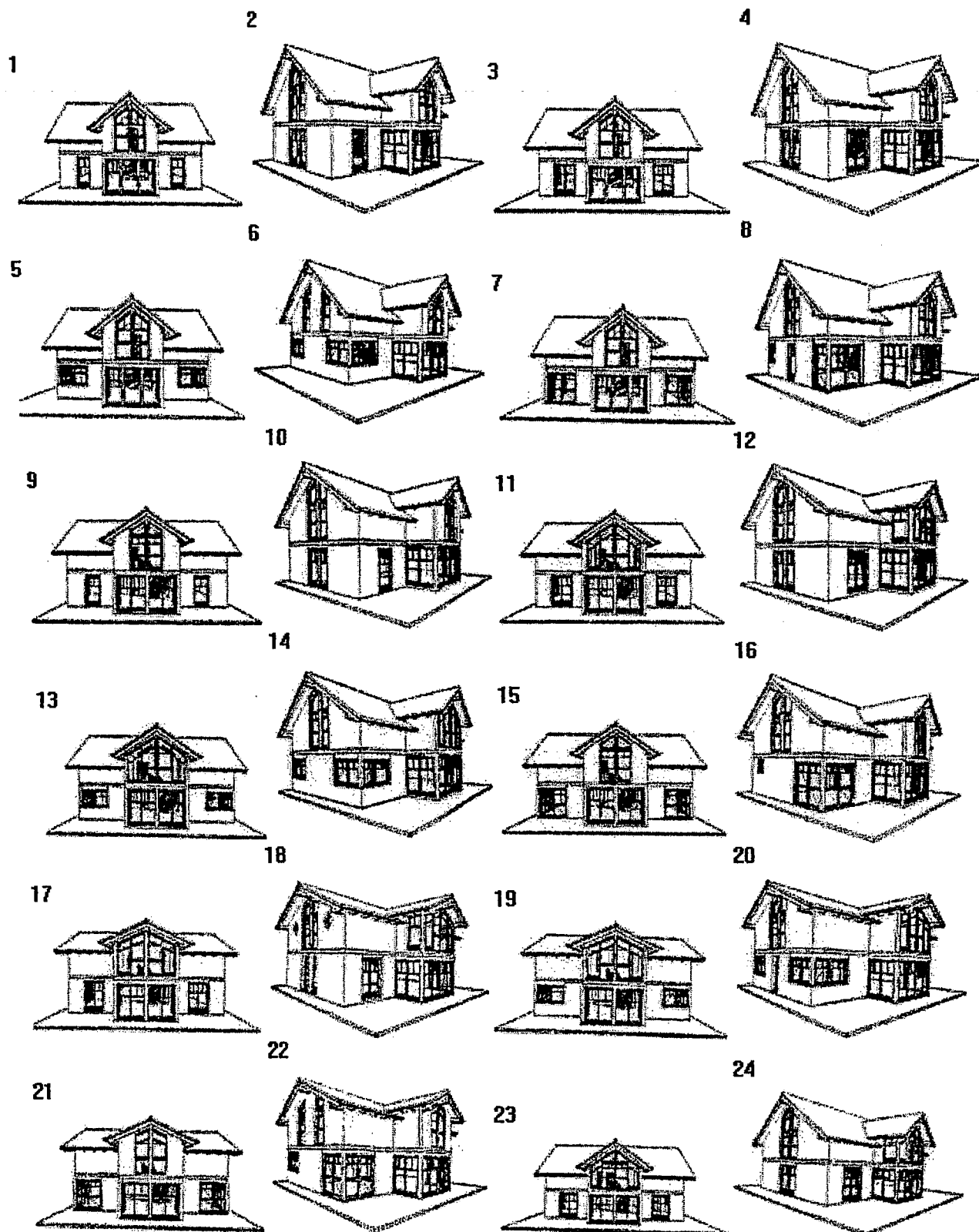

Dépôts publiés selon l'Acte de 1960 / Deposits Published Under the 1960 Act

(11) DM/060 460 (15) 25.03.2002

(73) BERND CROONENBROCK, Limbergring 9, D-59757 Arnsberg (DE) – (86)(87)(88) DE – (74) Dipl.-Ing. Peter Sartorius Patentanwalt, 24, Elisabethenstrasse, D-68535 Neckarhausen (DE) – (28) 8 – (54) Lights /Luminaires – (51) Cl. 26-05 – (81) I. BX, CH, DE, FR, IT, LI, SI, YU. II. ES

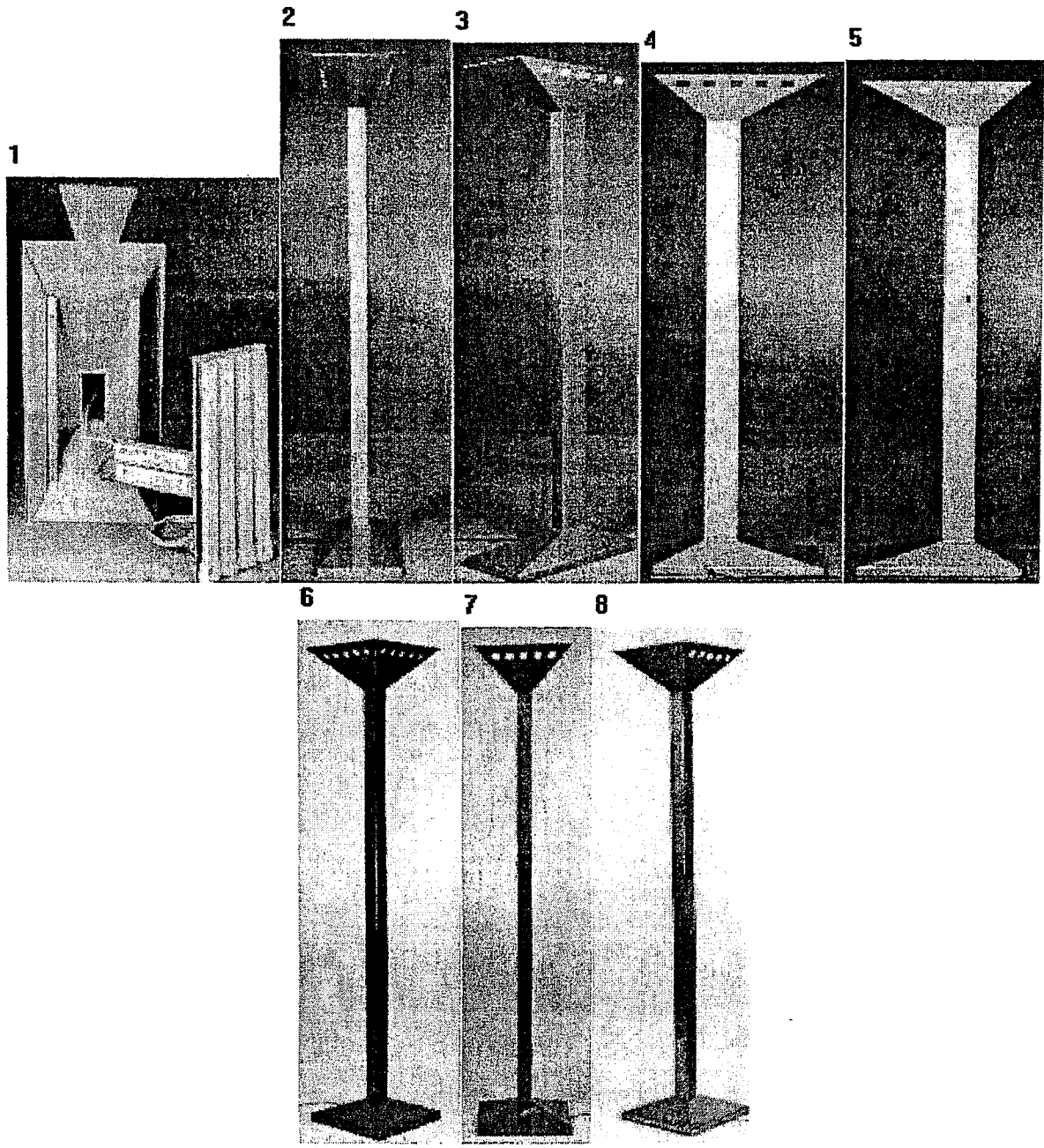

Dépôts publiés selon l'Acte de 1960 / Deposits Published Under the 1960 Act

(11) DM/060 487 (15) 21.03.2002

(73) ARTEMIDE GROUP S.P.A., 18, via Bergamo, I-20010 PREGNANA MILANESE (IT) – (86)(87)(88) IT – (74) JORIO Paolo et al c/o STUDIO TORTA S.r.l., 9, Via Viotti, I-10121 TORINO (IT) – (72) Ernesto Gismondi – (28) 3 – (54) Lamps / Lampes d'éclairage – (51) Cl. 26-05 – (57) The lamps comprise a circular base, a disc-shaped lighting head, and a rod connecting the circular base to the lighting head; opposite longitudinal ends of the rod are connected to the circular base and the lighting head respectively by articulated joints / Ces lampes comprennent un socle circulaire, une tête d'éclairage en forme de disque, ainsi qu'un bras de type tige reliant la base circulaire à la tête d'éclairage; les extrémités longitudinales opposées du bras sont reliées au socle circulaire et à la tête d'éclairage, au moyen d'articulations respectives. (81) I. BX, CH, DE, FR, GR, HU, IT, KP, SI, YU

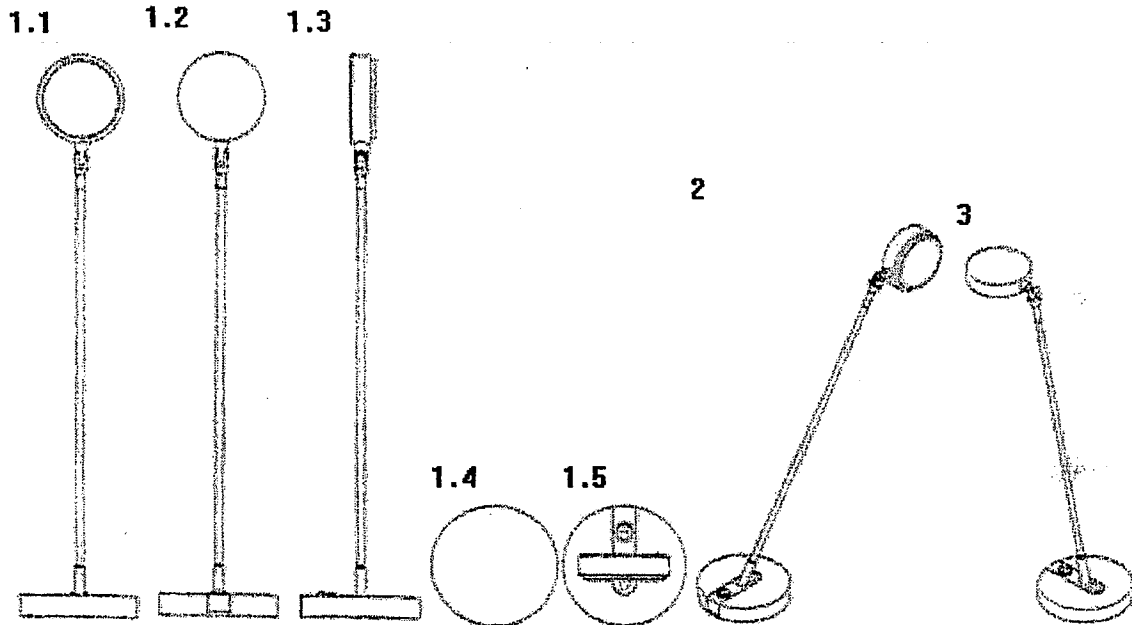

Dépôts publiés selon l'Acte de 1960 / Deposits Published Under the 1960 Act

(11) DM/060 458 (15) 11.06.2002

(73) MANUFACTURE D'ARTICLES DE PRECISION ET DE DESSIN - M.A.P.E.D. A CORPORATION ORGANIZED UNDER THE LAWS OF FRANCE, Route de Pringy ARGONAY, F-74370 PRINGY (FR) - (86)(87)(88) FR - (74) Cabinet GERMAIN ET MAUREAU, 12, rue Boileau, F-69006 LYON (FR) - (28) 1 - (54) Office perforator *Perforatrice de bureau* - (51) Cl. 19-02 - (81) I. BX, CH, DE, FR, GR, IT, MA, RO, SI. II. AN, EG, ES, ID, TN, VA

1.1

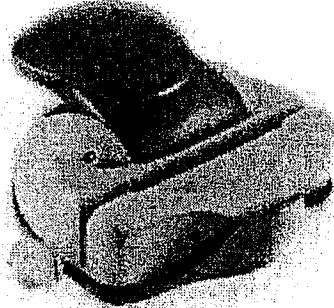

1.2

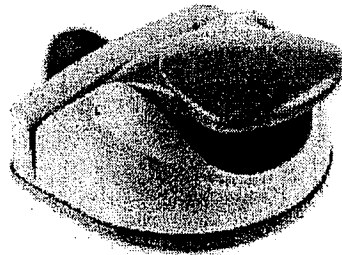

1.3

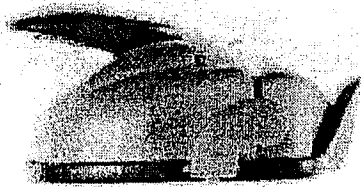

1.4

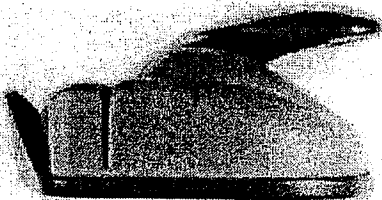

1.5



1.6

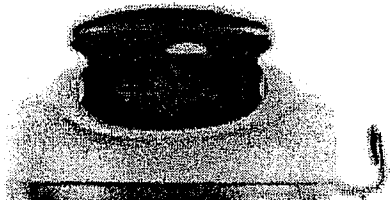

1.7

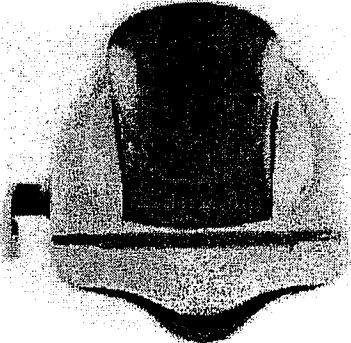

1.8

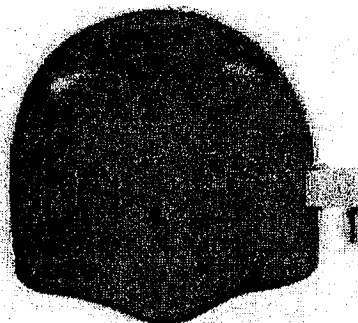

Dépôts publiés selon l'Acte de 1960 / Deposits Published Under the 1960 Act

(11) DM/060 539 (15) 01.07.2002

(73) VITRY FRERES (SOCIÉTÉ ANONYME), 46/48, rue Lauriston, F-75116 PARIS (FR) – (86)(87)(88) FR – (74) CABINET REGIMBEAU, 20, rue de Chazelles, F-75847 PARIS CEDEX 17 (FR) – (28) 1 – (54) Ciseaux à ongles *Nail scissors* – (51) Cl. 28-03 – (81) I. BX, CH, DE, GR, IT. II. AN, EG, ES, ID, TN, VA. – (30) 04.02.2002, No 02 0802, FR

1.1



1.2

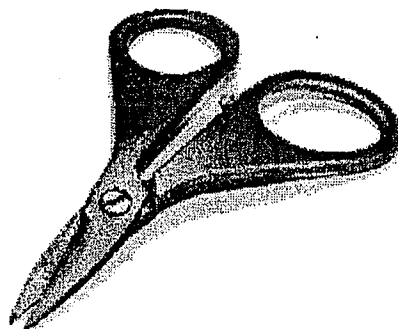

1.3



1.4

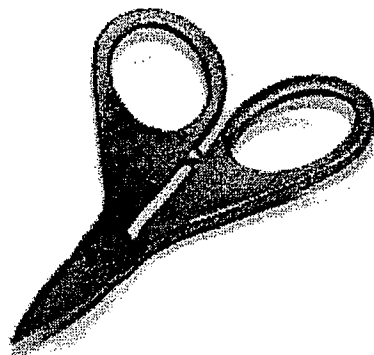

1.5

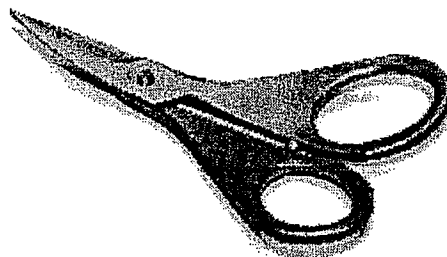

Dépôts publiés selon l'Acte de 1960 / Deposits Published Under the 1960 Act

(11) DM/060 581 (15) 22.05.2002

(73) PAULMANN LICHT GMBH, 2, Quezinger Feld, D-31832 Springe-Völksen (DE) – (86)(87)(88) DE – (74) Dr. Kurt-Rudolf Eikenberg Patentanwalt, 1 Schackstrasse, D-30175 Hannover (DE) – (28) 21 – (54) Bulbs for electric lamps / Ampoules pour lampes électriques – (51) Cl. 26-04 – (81) I. BX, DE, FR, IT. II. EG, ES, TN, VA

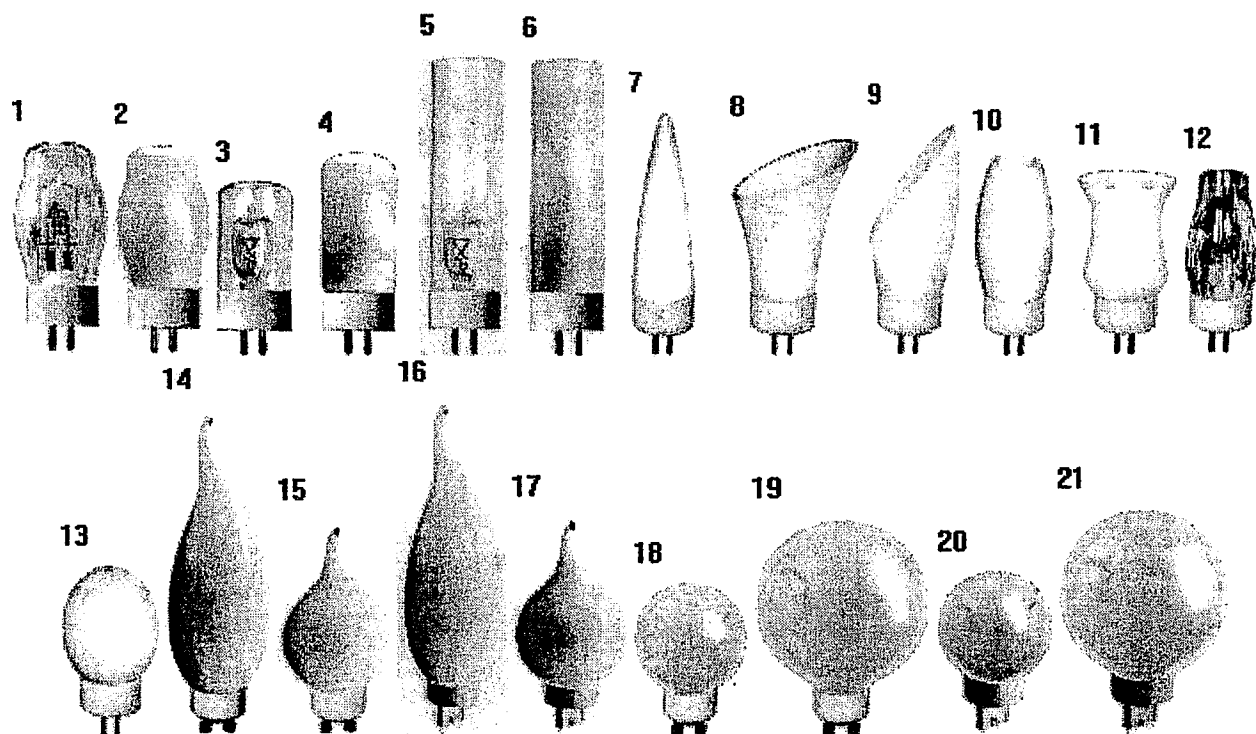

Dépôts publiés selon l'Acte de 1960 / Deposits Published Under the 1960 Act

(11) DM/060 470 (15) 26.06.2002

(73) SONY OVERSEAS SA, Rütistrasse 12, CH-8952 Schlieren (CH) – (86)(87)(88) CH – (74) William Blanc & Cie Conseils en propriété industrielle S.A., Avenue du Pailly 25, CH-1220 Les Avanchets / Genève (CH) – (72) Shin Miyashita – (28) 1 – (54) Video camera combined with video tape recorder and player/recorder for recording media *Caméra vidéo avec magnéscope et lecteur/enregistreur intégrés* – (51) Cl. 14-01 – 16-01 – (81) I. BG, BJ, BX, CH, CI, DE, FR, GR, HU, IT, KP, LI, MA, MC, MD, MK, MN, RO, SI, SN, SR, YU. II. AN, EG, ES, ID, TN, VA. – (30) 08.02.2002, No 2002-3117, JP

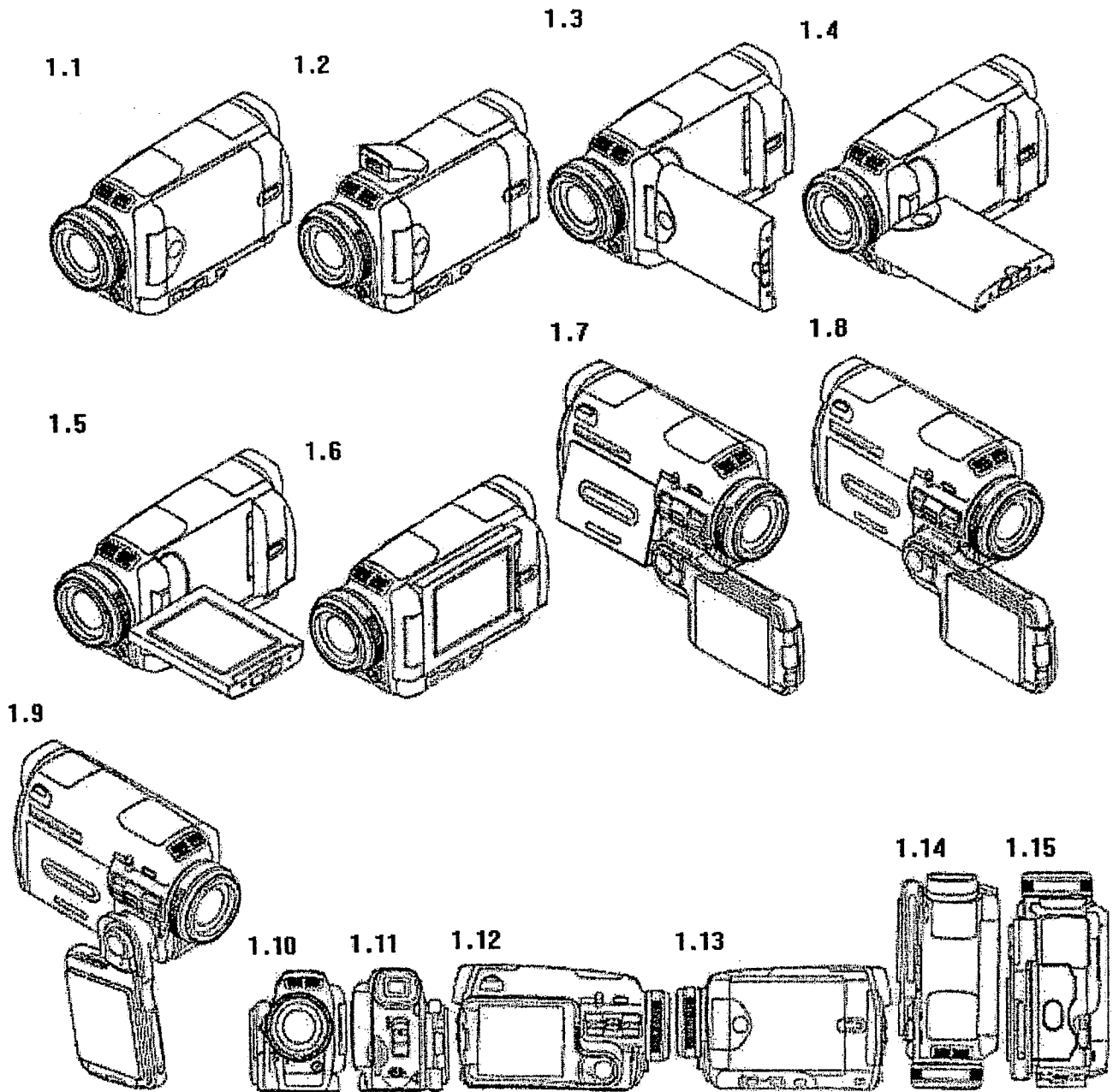

Dépôts publiés selon l'Acte de 1960 / Deposits Published Under the 1960 Act

(11) DM/060 450 (15) 24.05.2002

(73) SEB (SOCIÉTÉ ANONYME), F-21260 SELONGEY (FR) – (86)(87)(88) FR – (28) 2 – (54) Cuiseurs vapeur / Steamers – (51) Cl. 07-02 – (81) I. BX, CH, DE, IT. II. AN, EG, ES, ID, TN, VA. – (30) 26.02.2002, No 02 1437, FR

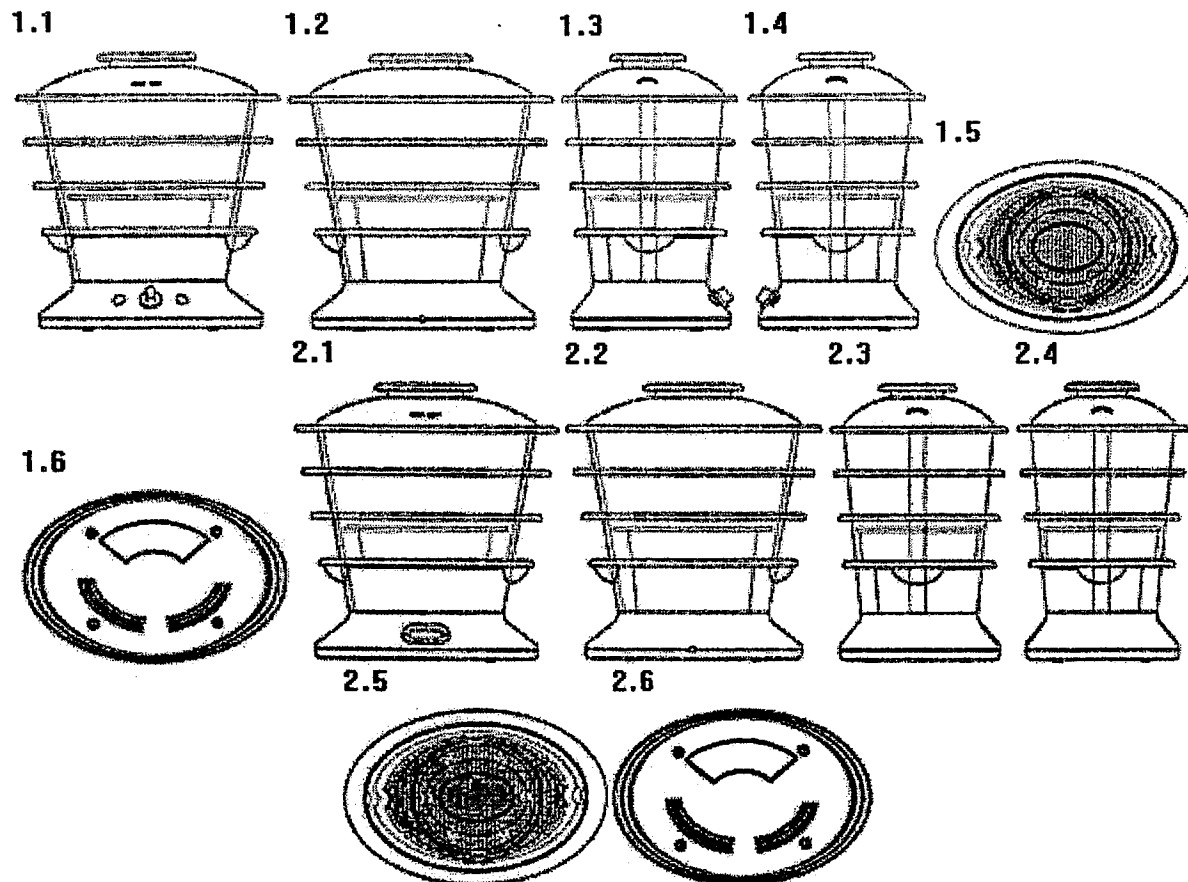

Dépôts publiés selon l'Acte de 1960 / Deposits Published Under the 1960 Act

(11) DM/060 463 (15) 21.03.2002

(73) SGL ITALIA S.R.L., 25, Strada San Mauro, I-10156 TORINO (IT) – (86)(87)(88) IT – (74) JORIO Paolo et al c/o STUDIO TORTA S.r.l., 9, Via Viotti, I-10121 TORINO (IT) – (28) 1 – (54) Coffee machine *Machine à café* – (51) Cl. 07-02 – (81) I. BX, CH, DE, FR, GR. – (30) 21.09.2001, No TO2001O 000280, IT

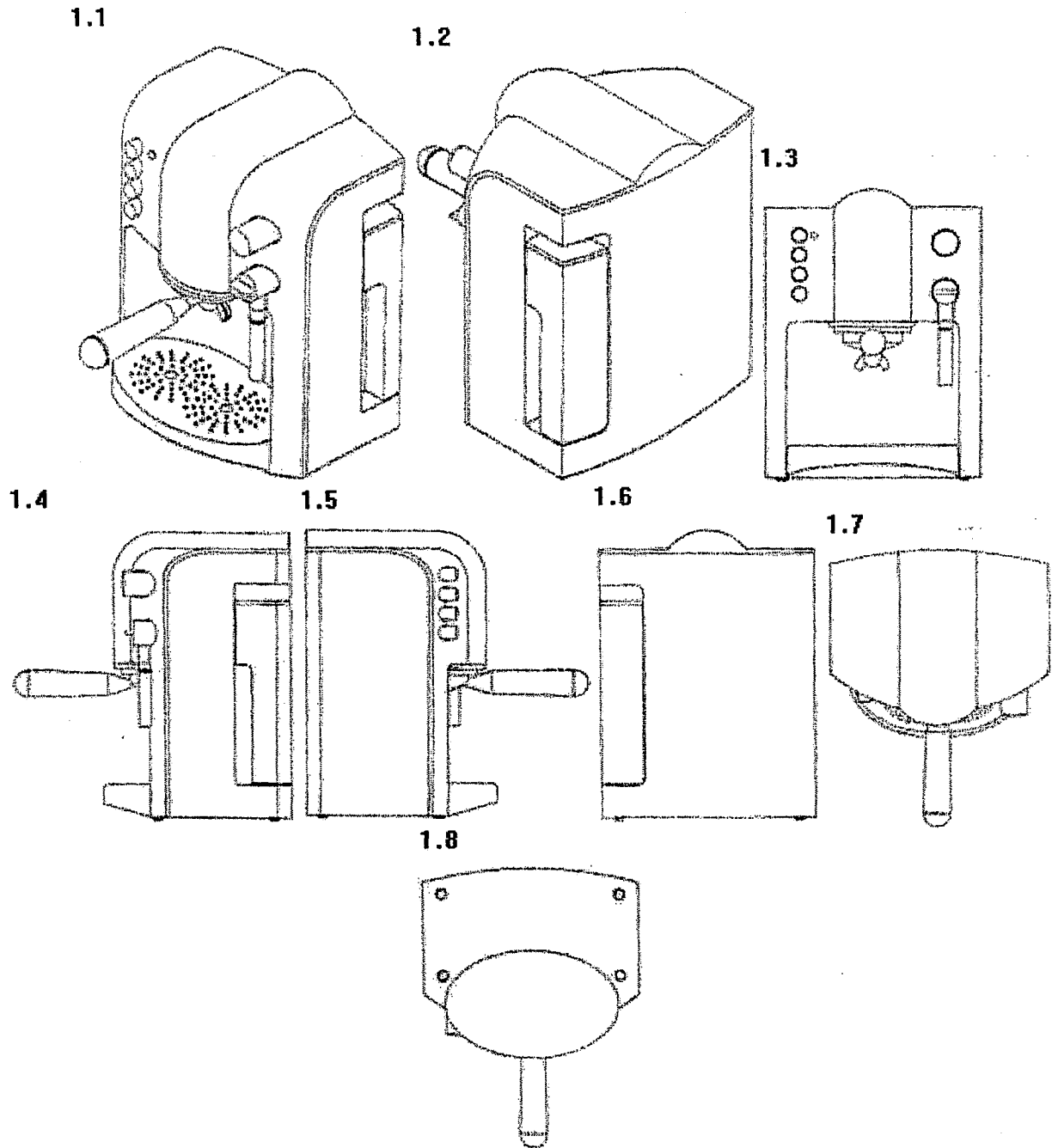

Dépôts publiés selon l'Acte de 1960 / Deposits Published Under the 1960 Act

(11) DM/060 474 (15) 21.05.2002

(73) CALOR SA, Place Ambroise Courtois, F-69008 LYON (FR) – (86)(87)(88) FR – (74) CABINET GERMAIN & MAUREAU, 12, rue Boileau, F-69006 LYON (FR) – (28) 2 – (54) Fers à repasser / Irons (flat-irons) – (51) Cl. 07-05 – (81) I. BX, CH, DE, HU, IT. II. AN, EG, ES, ID, TN, VA. – (30) 21.12.2001, No 01 7500, FR

1.1

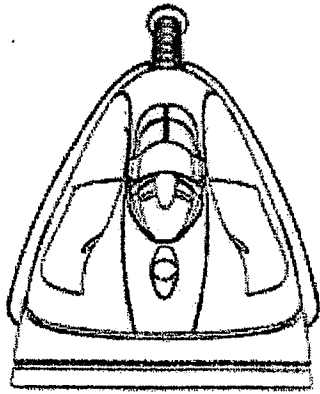

1.2

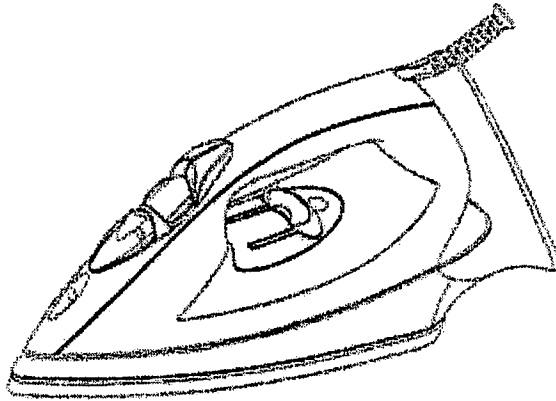

1.3

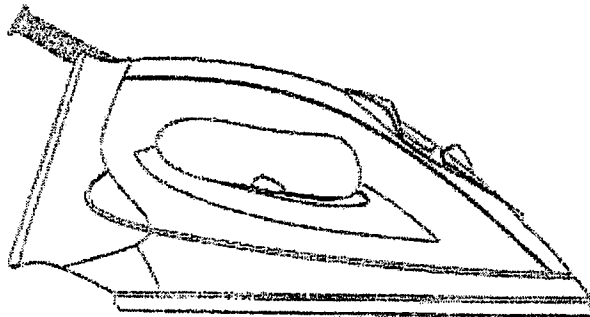

1.4

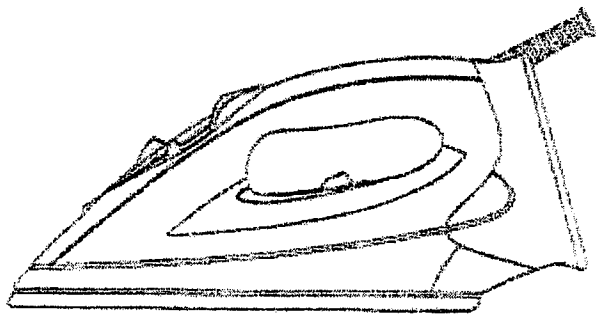

1.5

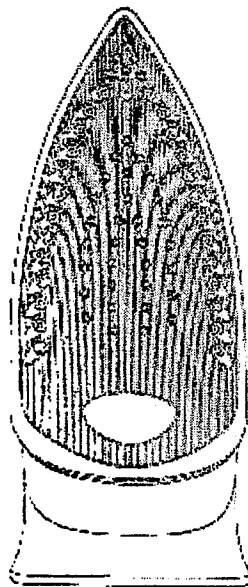

1.6

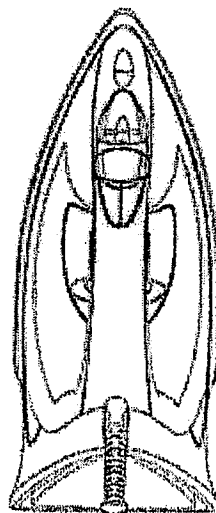

1.7

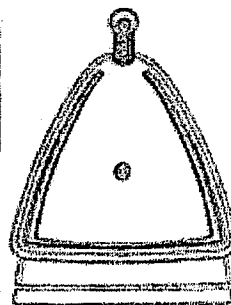

Dépôts publiés selon l'Acte de 1960 / Deposits Published Under the 1960 Act

(11) DM/060 623 (15) 06.05.2002

(73) BANDRIDGE EUROPE N.V., Watermolen 6, NL-4751 VK OUD GASTEL (NL) – (86)(87)(88) NL – (74) Octrooibureau Los en Stigter B.V., Weteringschans 96, NL-1017 XS Amsterdam (NL) – (28) 2 – (54) Plugs for audio/video appliances / *Fiches pour appareils audio et/ou vidéo* – (51) Cl. 13-03 – (81) I. BX, CH, DE, FR, GR, HU, IT, SI

1.1

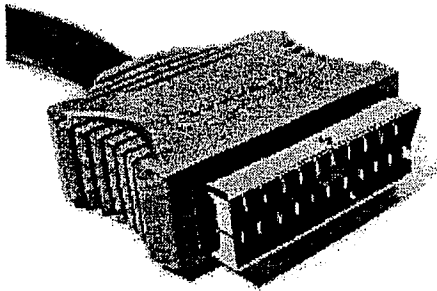

1.2

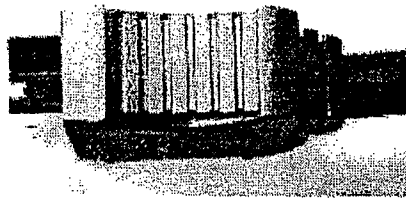

1.3

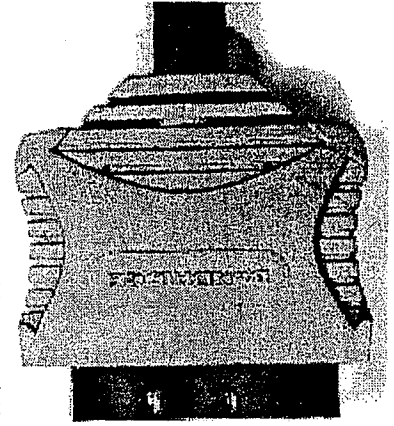

2.1

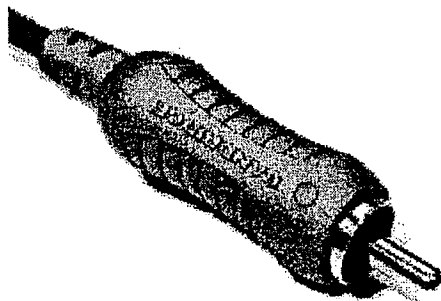

2.2

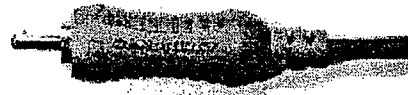

2.3



Dépôts publiés selon l'Acte de 1960 / Deposits Published Under the 1960 Act

(11) DM/060 499 (15) 14.05.2002

(73) I.C.S. B.V., Marisstraat 23, NL-3364 AZ Sliedrecht (NL) – (86)(87)(88) NL – (74) Verkuijl Consultants, Postbus 3502, NL-4800 DM Breda (NL) – (28) 2 – (54) Undercarriages for perambulators / *Châssis de roulement pour poussettes* – (51) Cl. 12-12 – (81) I. BX, FR, IT

1.1

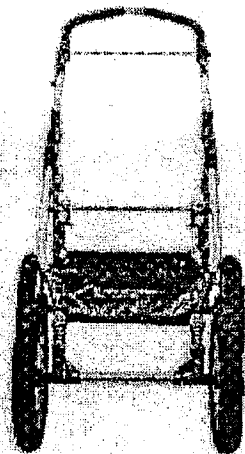

1.2

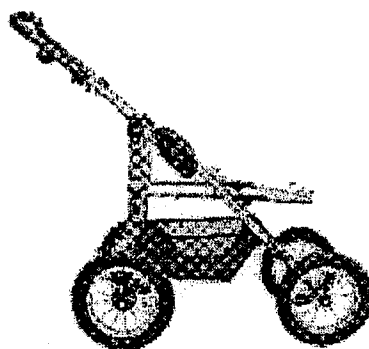

1.3

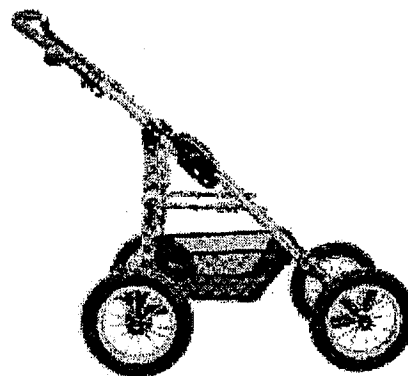

2.1

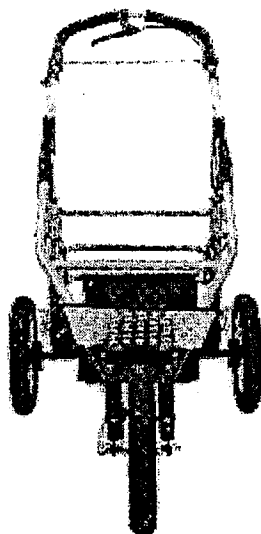

1.4

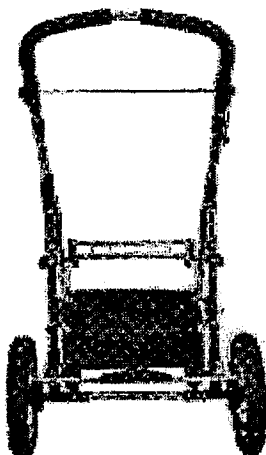

2.3

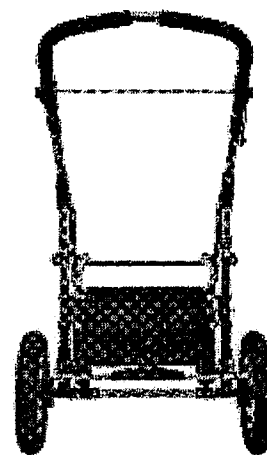

2.2

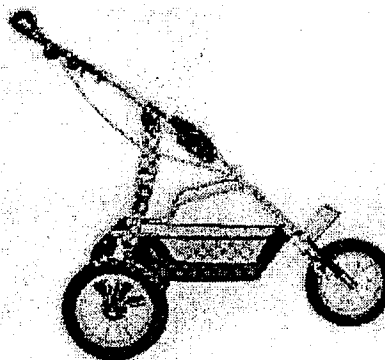

Dépôts publiés selon l'Acte de 1960 / Deposits Published Under the 1960 Act

(11) DM/060 664 (15) 16.07.2002

(73) DR.ING.H.C.F. PORSCHE AKTIENGESELLSCHAFT, Porscheplatz 1, D-70435 Stuttgart (DE) – (86)(87)(88) DE –
(74) Isler & Pedrazzini AG, Postfach 6940, CH-8023 Zürich (CH) – (28) 1 – (54) Rear structure for a motor vehicle,
especially racing car / *Structure pour arrière de véhicule à moteur, notamment pour voiture de course-* (51) Cl. 12-16 –
(81) I. CH, DE, FR, IT, IL, AN, EG, ES, ID, TN, VA. – (30) 26.01.2002, No 402-00-805.7, DE

1.1

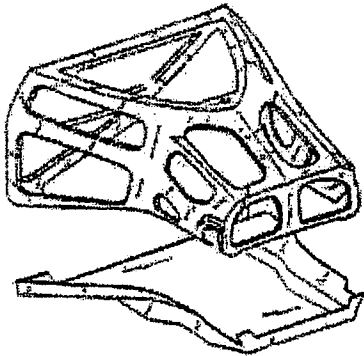

1.2

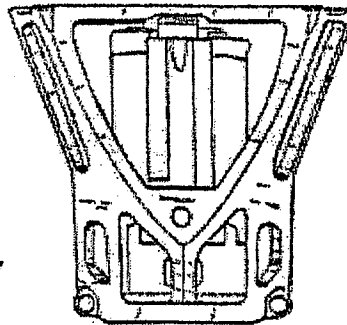

1.3

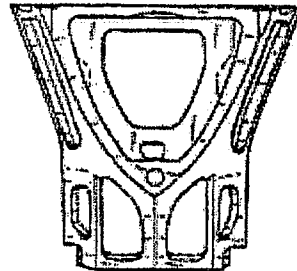

1.4

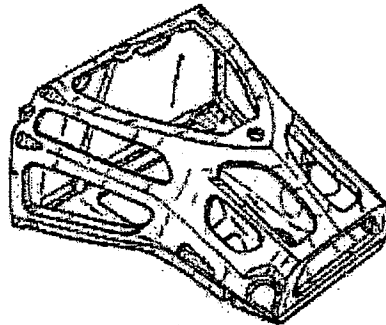

Dépôts publiés selon l'Acte de 1960 / Deposits Published Under the 1960 Act

(11) DM/060 557 (15) 13.02.2002

(73) VOLKSWAGEN AKTIENGESELLSCHAFT, D-38436 Wolfsburg (DE) – (86)(87)(88) DE – (28) 25 – (54) Wheel rims and wheel caps / Jantes et enjoliveurs de roue – (51) Cl. 12-16 – (81) I. BX, CH, DE, FR, GR, IT. II. AN, EG, ES, ID, TN, V/ – (30) 23.08.2001, No 401 07 421.8, DE – (46) 23.08.2002

1.1

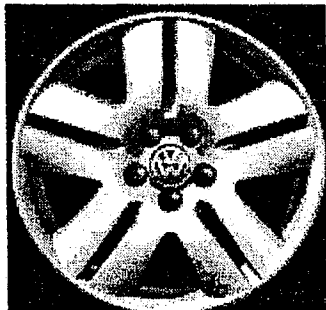

1.2

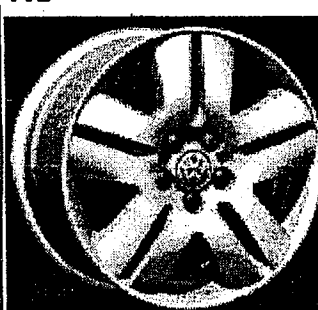

2.1

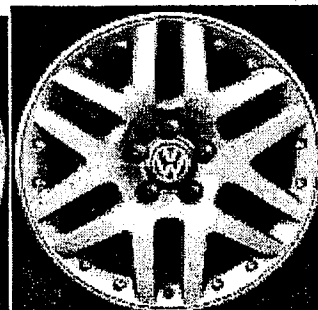

2.2

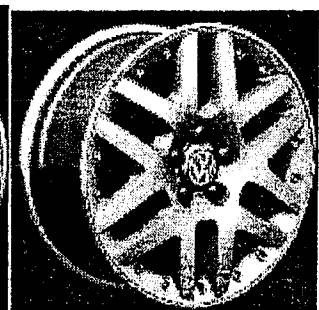

3.1

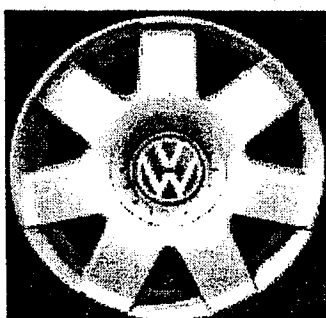

3.2

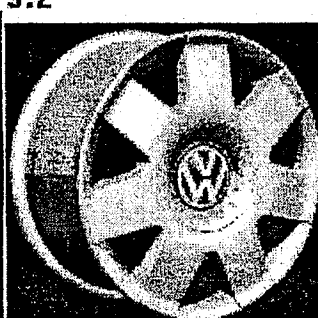

4.1

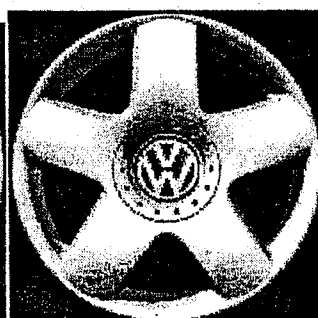

4.2



5.1

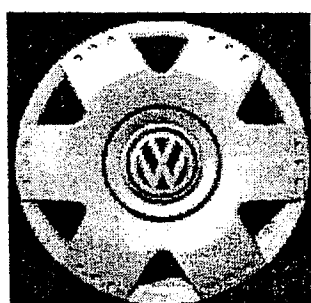

5.2

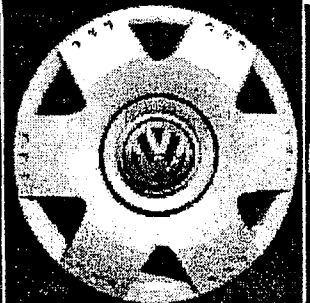

6.1

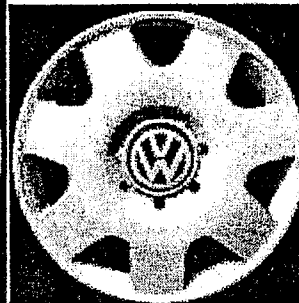

6.2

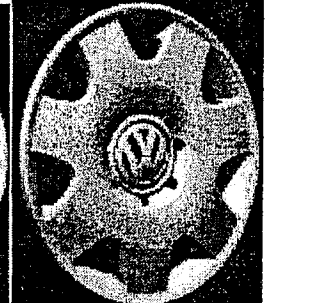

7.1

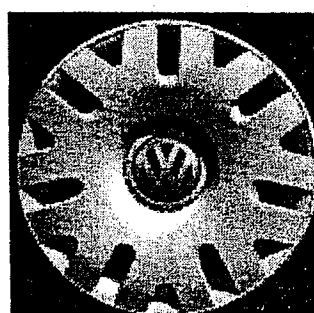

7.2

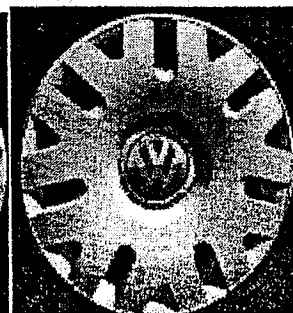

8.1

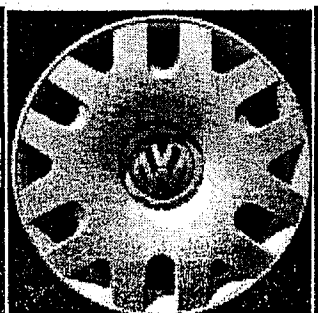

8.2

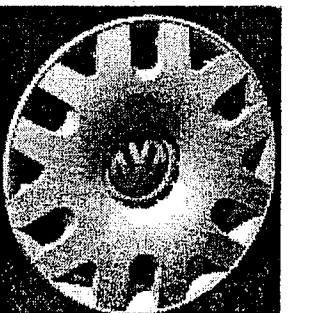

Dépôts publiés selon l'Acte de 1960 / Deposits Published Under the 1960 Act

(11) DM/060 617 (15) 10.07.2002

(73) VOLKSWAGEN AKTIENGESELLSCHAFT, D-38436 Wolfsburg (DE) – (86)(87)(88) DE – (28) 1 – (54) Vehicle /
Véhicule – (51) Cl. 12-08 – (81) I. BX, CH, DE, FR, GR, IT. II. AN, EG, ES, ID, TN, VA. – (30) 01.02.2002, No 402 00 890.1
DE

1.1



1.2

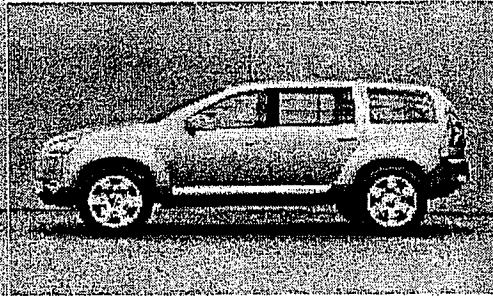

1.3



1.4



1.5



1.6



1.7

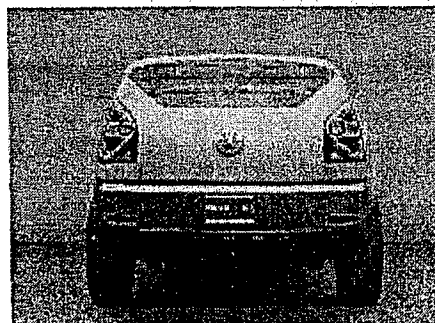

Dépôts publiés selon l'Acte de 1960 / Deposits Published Under the 1960 Act

(11) DM/060 561 (15) 10.05.2002

(73) KOMATSU UTILITY EUROPE S.P.A., Via Bergoncino, 28, I-36025 NOVENTA VICENTINA (Vicenza) (IT) - (86)(87)(88) IT - (74) RUFFINI Stefano c/o BUGNION S.p.A., via G. Garibaldi, 19, I-37121 VERONA (IT) - (28) 1 - (54) Telescopic handler / Chariot élévateur à flèche télescopique - (51) Cl. 12-05 - (81) I. BX, CH, DE, FR, IT - (46) 10.08.2002

1.1

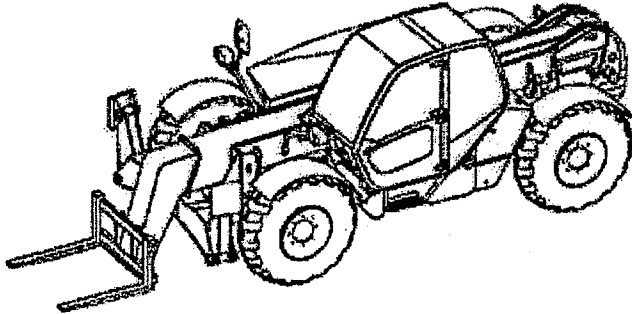

1.2

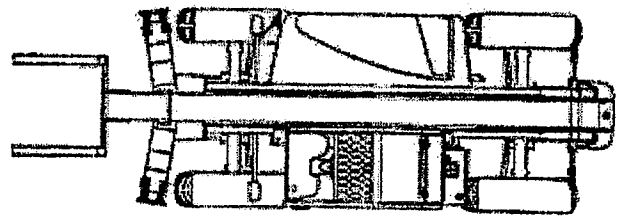

1.3

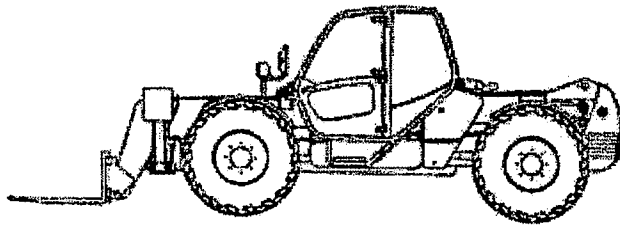

1.4

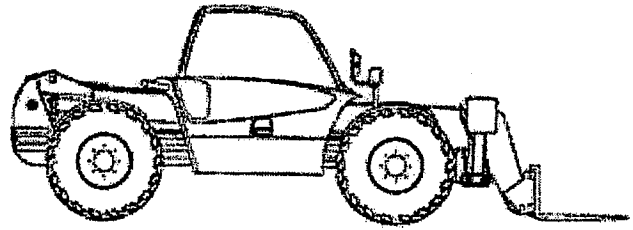

1.5

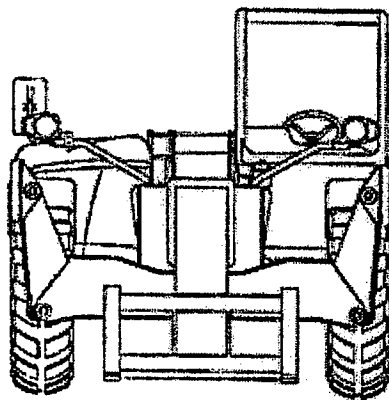

1.6

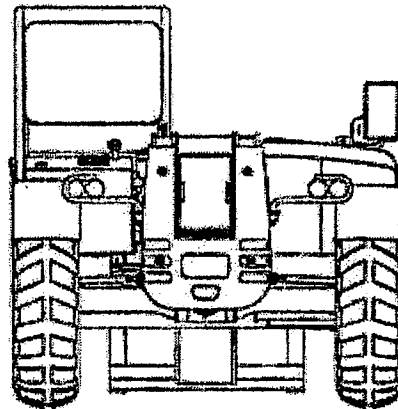

Dépôts publiés selon l'Acte de 1960 / Deposits Published Under the 1960 Act

(11) DM/060 555 (15) 30.01.2002

(73) ASTRAZENECA AB, SE-151 85 Södertälje (SE) – (86)(87) SE (88) DE – (74) Global Intellectual Property AstraZeneca AB, SE-151 85 Södertälje (SE) – (72) SHAW, Derek; LAW, Brian; HYNNINEN, Tom; KOIVISTOINEN, Juha – (28) 2 – (54) Injection devices / *Dispositifs d'injection* – (51) Cl. 24-02 – (81) I. BX, CH, DE, FR, GR, HU, IT, LI, MC, RO, SI, II. ES. - (30) 01.08.2001, No 011253, SE – (46) 01.08.2002

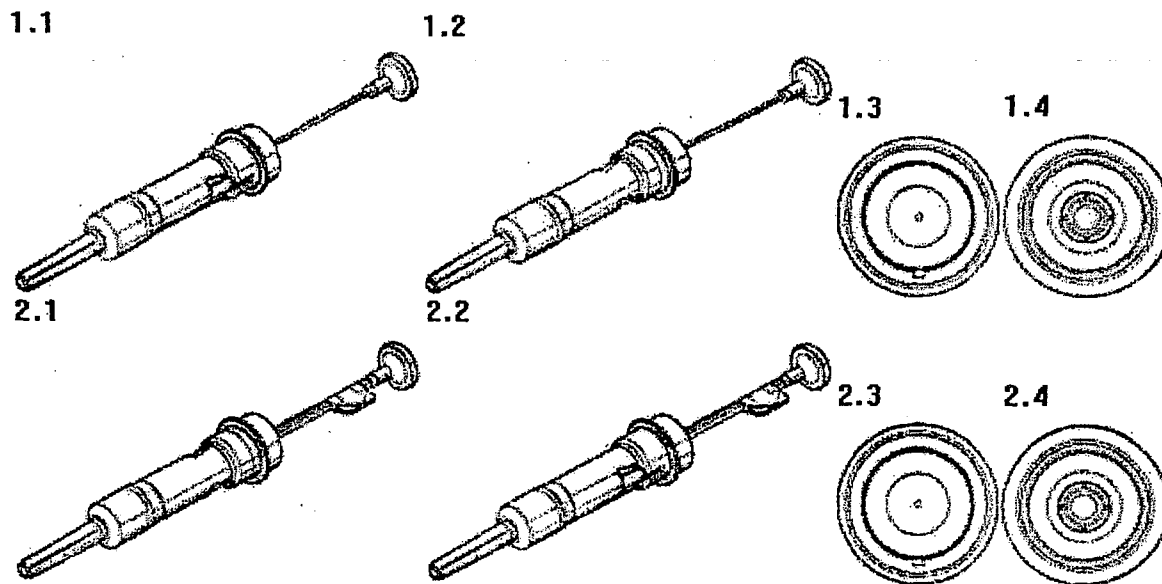

[L'appendice II suit]

