



**WIPO**

WORLD  
INTELLECTUAL PROPERTY  
ORGANIZATION



# Regional Seminar on the PCT and PATENTSCOPE for African Countries

**Kigali, Rwanda  
10-12 December  
2018**

Sandrine Ammann  
Marketing & Communications Officer

to be  
point of view.

**History** ['hɪstəri]

events of the  
past develop  
information

# Timeline

- April 2006: electronic publication of the PCT Gazette
- September 2006: new search features
- 2007-2008: addition of new search features
- September 2009: national collections
- Since 2009: New tools CLIR, WIPO Translate....

# The reason for its creation

- Easily search content

# Patent documents

- 100+ million patent documents published to date
  - 2+ million new patent applications published yearly
  - Technical information never published elsewhere
  - Highly standardized format
- A unique source of information

# Users of patent information

- Individual inventors
- Academic institutions
- Research institutions
- Small and medium enterprises (SMEs)
- Industry
- Government agencies
- Patent attorneys
- and many others...

# Uses of patent information

- Legal
- Technical
- Business
- Policy

# Uses of patent information

- Determine the patentability of your inventions
- Draft strong patent applications
- Determine the validity of existing patents and which technologies belong to the public domain
- Avoid patent infringement



# Patentability

- Novelty
- Inventive step, or non-obviousness
- Industrial applicability, or utility
- Patentable subject matter

# Scenario

- A manufacturer of wind turbines would like to identify new technologies to incorporate into its products.
  - The manufacturer would also like to know whether these technologies can be exploited freely, or whether licenses must be obtained from patent holders.
- Avoid patent infringement



Photo source: Pavel Ševela / Wikimedia Commons

# PATENTSCOPE



**PATENTSCOPE**

Search International and National Patent Collections

Mobile | Deutsch | Español | Français | 日本語 | 한국어 | Português | Русский | 中文 | العربية |

WORLD INTELLECTUAL PROPERTY ORGANIZATION

Search | Browse | Translate | News



Home > IP Services > PATENTSCOPE

## Simple Search

Using PATENTSCOPE you can search 72 million patent documents including 3.5 million published international patent applications (PCT). Detailed coverage information can be found here [↗](#)

Front Page

"wind turbines"



Office:All

Search

**i** PCT Publication 49/2018 (06.12.2018) is now available. The next publication date is scheduled as follows: Gazette number 50/2018 (13.12.2018). [More](#)

# Record

Machine translation

## 1. (WO2001069081) BEARING FOR AN ADJUSTABLE ROTOR BLADE ON A WIND ENERGY PLANT

PCT Biblio. Data

Description

Claims

Drawings

National Phase

Notices

Documents

Latest bibliographic data on file with the International Bureau

PermaLink

**Pub. No.:** WO/2001/069081 **International Application No.:** PCT/EP2001/002008  
**Publication Date:** 20.09.2001 **International Filing Date:** 22.02.2001  
**Chapter 2 Demand Filed:** 18.07.2001

**IPC:** F03D 11/00 (2006.01), F16C 19/18 (2006.01), F16C 19/54 (2006.01) ?

**Applicants:** WOBLEN, Aloys [DE/DE]; DE

**Inventors:** WOBLEN, Aloys; DE

**Agent:** EISENFÜHR, Günther; Eisenführ, Speiser & Partner Martinstrasse 24 28195 Bremen, DE

**Priority Data:** 100 11 464.4 10.03.2000 DE

**Title**  
(EN) BEARING FOR AN ADJUSTABLE ROTOR BLADE ON A WIND ENERGY PLANT  
(FR) PALIER POUR UNE PALE DE ROTOR REGLABLE D'UNE EOLIENNE  
(DE) LAGERUNG EINES VERSTELLBAREN ROTORBLATTS EINER WINDENERGIEANLAGE

**Abstract:**  
(EN) The invention relates to the bearing for an adjustable rotor blade on the rotor hub of a wind energy plant, with a roller bearing as the pivot bearing for the positioning drive, which can transfer high axial forces and large twisting moments with low relative movements between the bearing halves. One bearing half comprises a bearing ring with two positive-fit rows of roller bodies, radially offset from each other and the other bearing half comprises a bearing ring engaging with the above with a U-shaped section. The bearing ring for the rotor blade, forming the other bearing half, comprises two rings (10, 12) of varying diameter, which are independently fixed to the rotor blade (3). The circular root of the hollow rotor blade is split into two sub-shells (3a, 3b) and each sub-shell is fixed to one of the both rings (10, 12), of the one bearing ring.

(FR) L'invention concerne un palier pour une pale de rotor réglable montée sur un moyeu de rotor d'une éolienne. Dans ce palier, le palier pivotant du mécanisme de positionnement se présente sous la forme d'un palier à roulement, servant à transmettre des forces axiales et des couples de flexion élevés, lors de faibles mouvements relatifs entre les éléments de paliers. Ce palier à roulement comprend une bague de roulement destinée à un élément de palier et recevant par liaison de forme deux rangées de corps de roulement, décalées dans le sens radial, et une bague de roulement destinée à l'autre élément de palier et entourant les corps de roulement en formant un U en coupe transversale. La bague de roulement pour la pale de rotor formant l'autre élément de palier est constituée de deux bagues (10, 12) de différents diamètres, qui sont fixées sur la pale de rotor (3), indépendamment l'une de l'autre. La racine circulaire de la pale de rotor creuse (3) est divisée en deux coques partielles (3a, 3b), chacune de ces dernières étant fixée sur une des deux bagues (10, 12) d'une bague de roulement.

(DE) Die Lagerung eines verstellbaren Rotorblattes an der

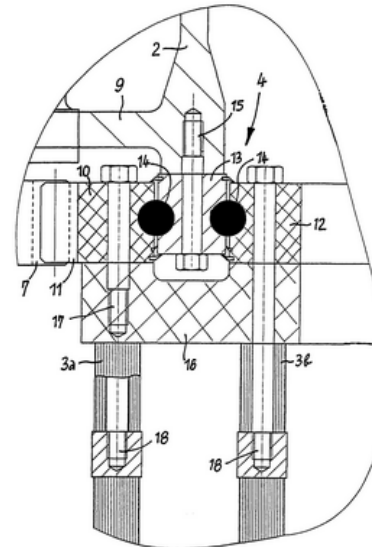

# Legal status: National phase

1. (WO2001069081) BEARING FOR AN ADJUSTABLE ROTOR BLADE ON A WIND ENERGY PLANT

PCT Biblio. Data

Description

Claims

Drawings

National Phase

Notices

Documents

Available information on National Phase entries(more information)

Office	Entry Date	National Number	National Status
South Africa	02.09.2002	200207033	
Japan	10.09.2002	2001567934	
Republic of Korea	09.09.2002	1020027011801	Published: 20.12.2002 Granted: 13.07.2007
South Africa	02.09.2002	2002/07033	
European Patent Office (EPO)	26.09.2002	2001907550	Published: 18.12.2002 Granted: 11.08.2004
Canada	04.09.2002	2402044	
Australia	02.09.2002	2001235488	Granted: 21.10.2004
India	02.09.2002	IN/PCT/2002/01120/KOL	Published: 25.11.2005 Granted: 03.05.2007
United States of America	17.12.2002	10220950	
New Zealand	12.09.2002	521333	Published: 28.10.2005 Granted: 09.02.2006

# Uses of patent information

- Develop new solutions to technical challenges faced in the country, or adapt existing technologies to suit local conditions
- Target research resources more effectively (avoid “reinventing the wheel”)
- Technical information must be sufficiently clear and comprehensive to be carried out by a typical expert in the field of technology (“a person having ordinary skill in the art”)

# Scenario



- A research laboratory aims to develop new wind turbine controller technologies and would like to know what has already been done in this area of research.

→ Avoid reinventing the wheel

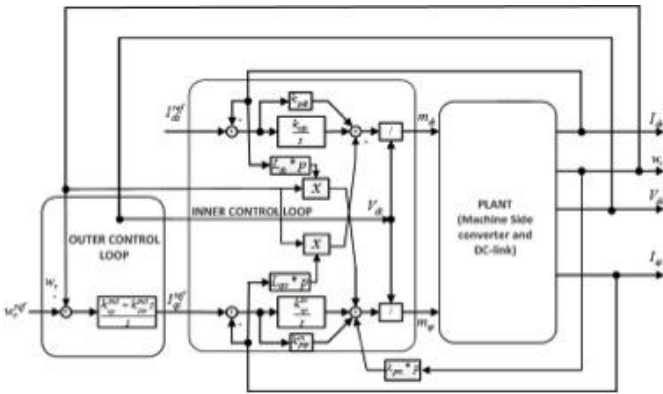

Sort by:  View  List Length   Side-by-side

Int.Class	Appl.No	Title	Applicant	Ctr	PubDate
1. WO/2018/218924	H02K 11/04	HIGH-VOLTAGE DIRECT CURRENT GENERATOR, WIND TURBINE SET, AND WIND FARM	BEIJING GOLDWIND SCIENCE & CREATION WINDPOWER EQUIPMENT CO., LTD.	WO	06.12.2018

A high-voltage direct current generator, a wind turbine set, and a wind farm. The high-voltage direct current generator comprises: an alternating current multi-winding generator (1), comprising N three-phase windings; 3N single-phase winding control circuits (2), each single-phase winding control circuit (2) comprising an alternating current input terminal that is used for receiving an alternating current as well as a direct current output terminal that is used for outputting a direct current, and the direct current output terminals of each single-phase winding control circuit being sequentially connected in series to form a high-voltage direct current output terminal; a generator output controller (3), which is used for controlling each single-phase winding control circuit (2) to perform a rectifying operation.

2. 20180328338	F03D 7/02	CONTROL METHOD, MASTER CONTROLLER SYSTEM, AND CENTRAL CONTROLLER FOR WIND TURBINES	BEIJING GOLDWIND SCIENCE & CREATION WINDPOWER EQUIPMENT CO., LTD.	US	15.11.2018
----------------	-----------	--	---	----	------------

A start control method for wind turbines (102), comprising: a master control determines whether its real-time wind speed reaches a preset start wind speed when a wind speed of at least one wind turbine (102) or anemometer tower in a wind farm reaches or exceeds the preset start wind speed; the master controller updates a corresponding number simulative start times when determining that its real-time wind speed reaches or exceeds the preset start wind speed, and starts the wind turbine (102) when the number of simulative start times reaches a preset count value. The present invention also relates to a master controller, a system, and a central controller for wind turbines (102).

3. WO/2018/204504	H02J 3/18	SYSTEM AND METHOD FOR REACTIVE POWER CONTROL OF A WIND FARM	GENERAL ELECTRIC COMPANY	WO	08.11.2018
-------------------	-----------	---	--------------------------	----	------------

A method for reactive power control of a wind farm having a plurality of clusters of wind turbines with a cluster transformer connecting each cluster of wind turbines to a power grid is provided. The method includes receiving, via a plurality of cluster-level controllers, a reactive power command from a farm-level controller. The method also includes generating, via the cluster-level controllers, a cluster-level reactive current command for each cluster of wind turbines based on the reactive power command. Further, the method includes distributing, via the cluster-level controllers, a turbine-level reactive current command to turbine-level controllers of the wind turbines based on the cluster-level reactive current command.

4. WO/2018/198225	F03D 7/04	AI DEVICE, LASER RADAR DEVICE, AND WIND FARM CONTROL SYSTEM	MITSUBISHI ELECTRIC CORPORATION	WO	01.11.2018
-------------------	-----------	---	---------------------------------	----	------------

The present invention addresses the problem of a conventional wind farm control system configuration in that it has been difficult to acquire high spatial-resolution information and impossible to obtain sufficient information necessary for expansion of machine learning. An artificial intelligence (AI) device of the present invention is provided with a learning device which performs machine learning concerning a wind under predicts the amount of power generated by a wind turbine, compares



# Scenario

- The manufacturer of wind turbines would like to identify its major competitors and potential partners to develop new technologies and products.

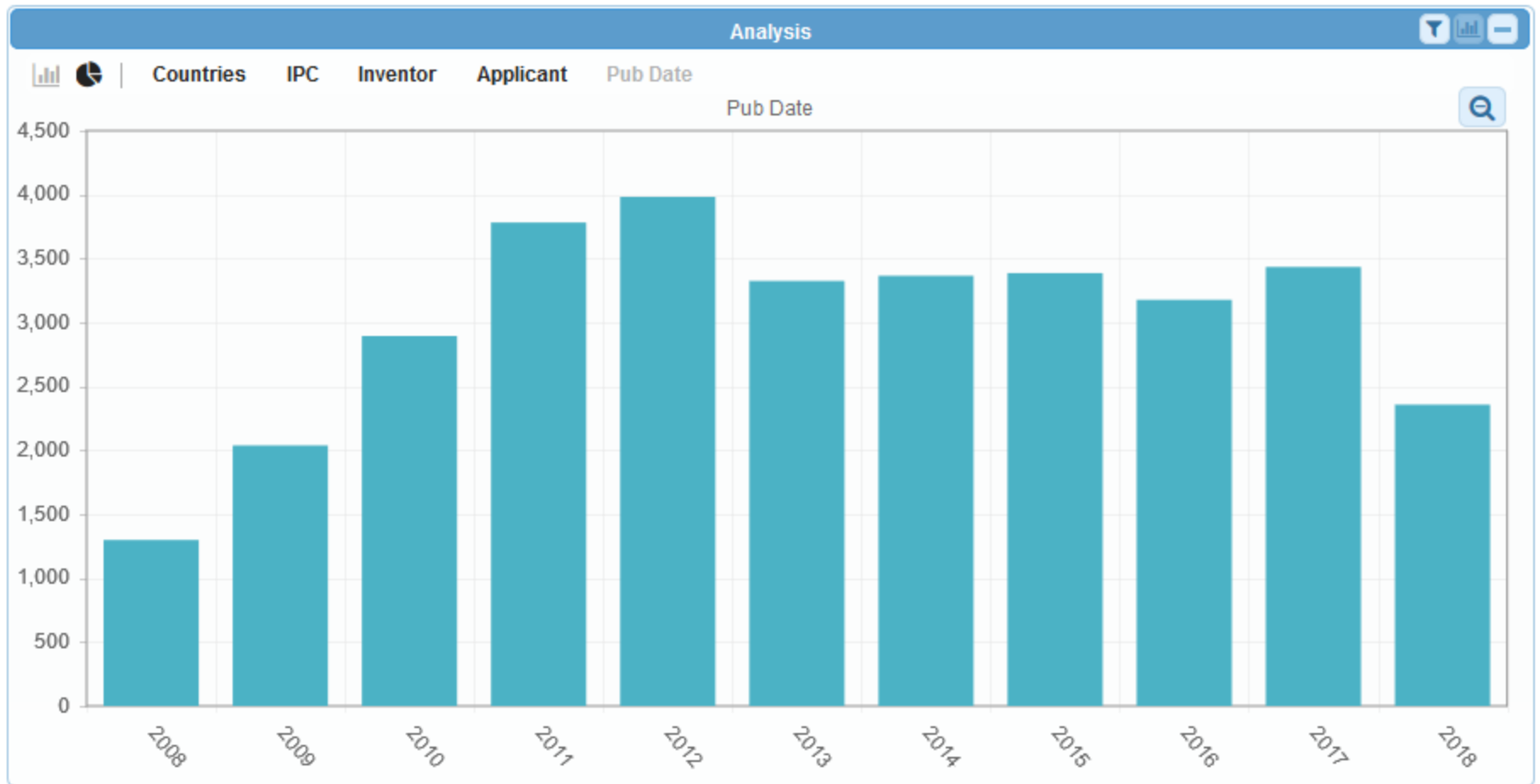

Photo source: W.Wacker (Wikimedia)

# Search results

Analysis 									
Countries		IPC		Inventor		Applicant		Pub Date	
Name	No	Name	No	Name	No	Name	No	Date	No
United States	7,840	F03D	28,431	STIESDAL HENRIK	143	VESTAS WIND SYSTEMS A/S	2,082	2008	1,299
European Patent Office	6,360	H02J	2,076	WOB BEN ALOYS	115	General Electric Company	1,330	2009	2,038
China	6,049	H02P	1,974	Stiesdal Henrik	101	VESTAS WIND SYS AS	1,087	2010	2,894
PCT	5,645	H02K	1,749	EGEDAL PER	66	SIEMENS AKTIENGESELLSCHAFT	1,006	2011	3,782
India	2,417	B29C	1,488	BECH ANTON	63	SIEMENS AG	957	2012	3,983
Canada	1,884	E04H	1,170	Christopher Daniel Caruso	55	Vestas Wind Systems A/S	904	2013	3,325
Australia	1,342	F16H	835	HANCOCK, Mark	55	GENERAL ELECTRIC COMPANY	829	2014	3,365
Denmark	1,335	B63B	781		54	GEN ELECTRIC	806	2015	3,386

# Filing trends



# Top applicants

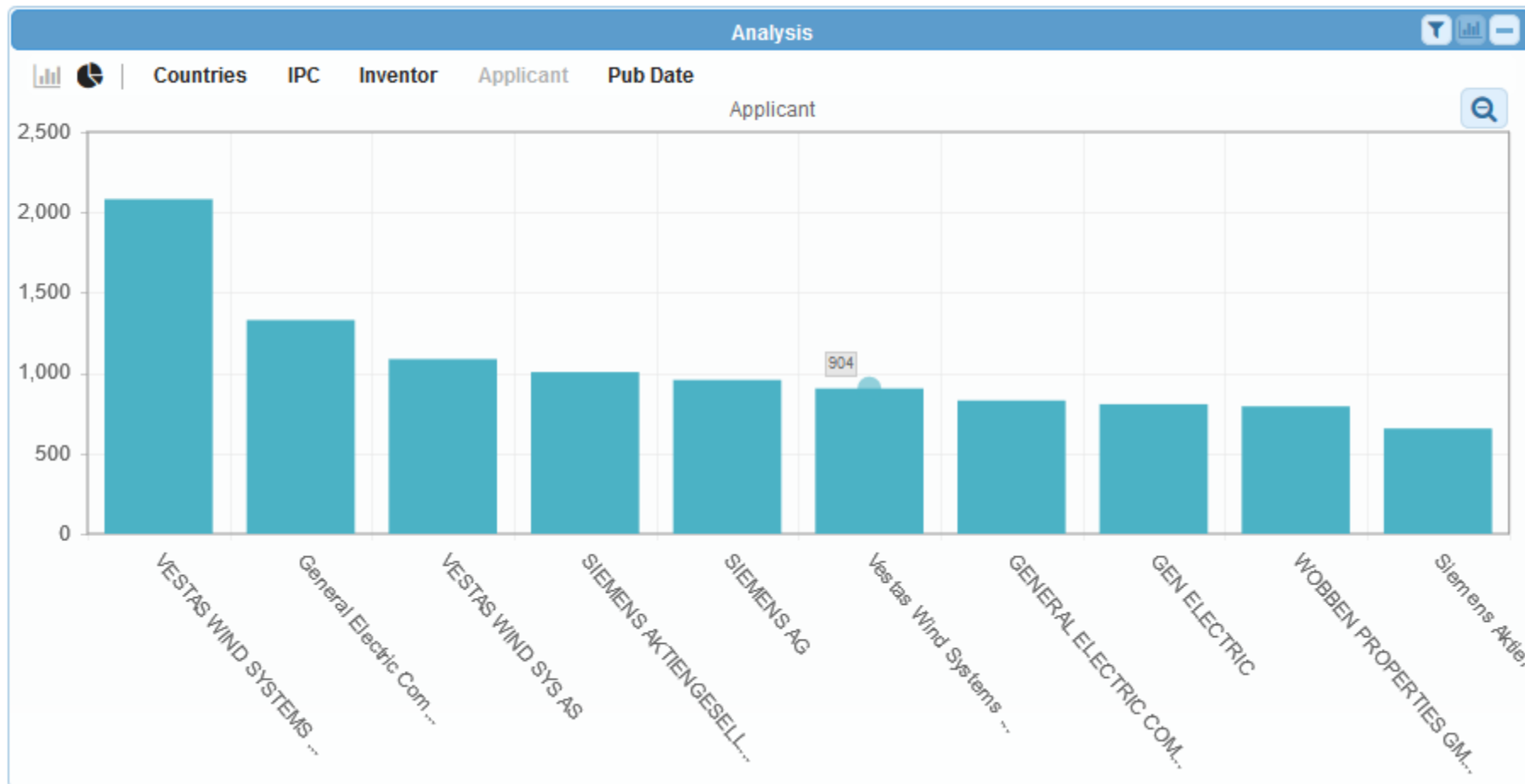

# Top offices of filing

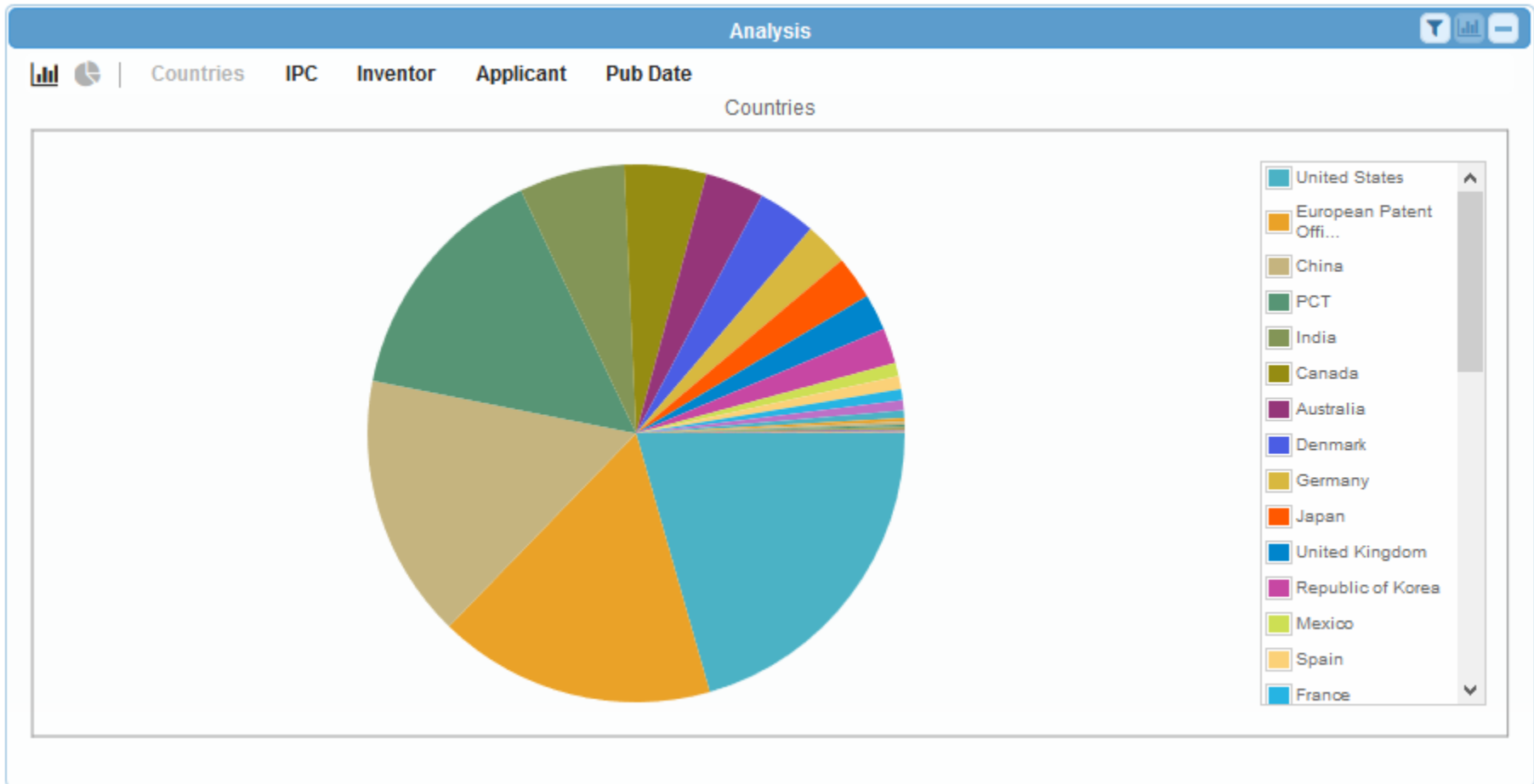

# <https://patentscope.wipo.int/>



## PATENTSCOPE

Search International and National Patent Collections

[Mobile](#) | [Deutsch](#) | [Español](#) | [Français](#) | [日本語](#) | [한국어](#) | [Português](#) | [Русский](#) | [中文](#) | [العربية](#)

WORLD INTELLECTUAL PROPERTY ORGANIZATION

[Search](#) | [Browse](#) | [Translate](#) | [News](#)



[Home](#) ▶ [IP Services](#) ▶ [PATENTSCOPE](#)

### Simple Search

Using PATENTSCOPE you can search 72 million patent documents including 3.5 million published international patent applications (PCT). Detailed coverage information can be found here [➔](#)

Front Page ▼



Office:All

[Search](#)

**i** PCT Publication 45/2018 (08.11.2018) is now available. The next publication date is scheduled as follows: Gazette number 46/2018 (15.11.2018). [More](#)



# PATENTSCOPE

Search International and National Patent Collections

Mobile | Deutsch | Español | Français | 日本語 | 한국어 | Português | Русский | 中文 | العربية

WORLD INTELLECTUAL PROPERTY ORGANIZATION

Search | Browse | Translate | News



## Simple Search

Using PATENTSCOPE you can search 72 million patent documents including 3.5 million published international patent applications (PCT). Detailed coverage information can be found here

Front Page



Office:All

Search

PCT Publication 45/2018 (08.11.2018) is now available. The next publication date is scheduled as follows: Gazette number 46/2018 (15.11.2018). [More](#)

**WIPO Translate**  
**WIPO Pearl**

**PATENTSCOPE News** 

- [New PATENTSCOPE Interface](#) (Sep 21, 2018)
- [Indian Patent Data now Available in PATENTSCOPE](#) (Mar 14, 2018)
- [Watch and Learn: New Tutorials for PATENTSCOPE](#) (Jan 30, 2018)
- [USPTO Dossier Content Now available in PATENTSCOPE](#) (Oct 24, 2017)
- [ASEAN Data Now Available In PATENTSCOPE](#) (Aug 30, 2017)

**Login**  
**Account Sign Up**



# WIPO Translate



**TRANSLATE**

Instant patent translation

[العربية](#) | [English](#) | [Español](#) | [Français](#) | [Русский](#) | [中文](#) |

[Home](#) | [IP Services](#) | [PATENTSCOPE](#) | [Database Search](#) | [WIPO translate](#)

## Translate

[\[Terms & conditions/User guide\]](#)

WIPO Translate NMT is a powerful instant translation tool, designed specifically to translate patent texts (now almost all languages are available using Neural Machine Translation technology). Simply cut and paste text from a patent document into the box below and select from the available language pairs, then click on "Translate".

Text to be translated:

Language pair:

Domain:

Translate

### Related links

- [WIPO Translate: Cutting-Edge Translation Tool For Patent Documents Extends Language Coverage](#)

# 32 Technical domains from the IPC

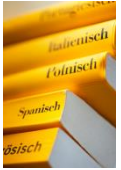

[ADMN] Admin, Business, Management & Soc Sci  
[AERO] Aeronautics & Aerospace Engineering  
[AGRI] Agriculture, Fisheries & Forestry  
[AUDV] Audio, Audiovisual, Image & Video Tech  
[AUTO] Automotive & Road Vehicle Engineering  
[BLDG] Civil Engineering & Building Construction  
[CHEM] Chemical & Materials Technology  
[DATA] Computer Sci, Telecom & Broadcasting  
[ELEC] Electrical Engineering & Electronics  
[ENGY] Energy, Fuels & Heat Transfer Eng  
[ENVR] Environmental & Safety Engineering  
[FOOD] Foods & Food Technology  
[GENR] Generalities, Language, Media & Info Sci  
[HOME] Home Contents & Household Maintenance  
[HORO] Precision Mechanics, Jewelry & Horology  
[MANU] Manufacturing & Materials Handling Tech

[MARI] Marine Engineering  
[MEAS] Standards, Units, Metrology & Testing  
[MECH] Mechanical Engineering  
[MEDI] Medical Technology  
[METL] Metallurgy  
[MILI] Military Technology  
[MINE] Mining, Oil & Gas Extraction & Minerals  
[NANO] Nano Technology  
[PACK] Packaging & Distribution of Goods  
[PRNT] Printing & Paper  
[RAIL] Railway Engineering  
[SCIE] Optical Engineering  
[SPRT] Sports, Leisure, Tourism & Hospitality  
[TEXT] Textile & Clothing Industries  
[TRAN] Transportation

# Language pairs

- ...
- English->Arabic (Neural MT Beta)
- Arabic->English (Neural MT Beta)
- English->German (Neural MT)
- German->English (Neural MT)
- English->Spanish (Neural MT)
- Spanish->English (Neural MT)
- English->French (Neural MT)
- French->English (Neural MT)
- English->Japanese (Neural MT)
- Japanese->English (Neural MT)
- English->Korean (Neural MT)
- Korean->English (Neural MT)
- English->Portuguese (Neural MT)
- Portuguese->English (Neural MT)
- English->Russian (Neural MT)
- Russian->English (Neural MT)
- English->Chinese (Neural MT)
- Chinese->English (Neural MT)
- Previous models (non-Neural)

WIPO Translate NMT is a powerful instant translation tool, designed specifically to translate patent texts (now almost all languages are available using Neural Machine Translation technology). Simply cut and paste text from a patent document into the box below and select from the available language pairs, then click on "Translate".

Text to be translated:

本发明公开了一种多用途的园林维护设备，其结构包括移动维修机、轮胎、滚轴、底盘、开关控制器、推把；为了实现多用途的园林维护设备能够实现打药和洒水并且移动方便，可以修枝剪叶清理地面杂草和落叶，移动维修机下设有轮胎，便于移动，驱动机构可以带动剪切机构对园林的植物进行修枝剪叶，通过地面清理装置能够将地面的杂草和落叶收集到垃圾收集框内，浇水装置配合注水室可以将药水直接浇注到植物上，推动柱带动洒水机构能够对地面进行洒水，提高了工作效率。

Language pair:

Chinese->English (Neural MT) ▾

Domain:

ADMN-Admin, Business, Management & Soc Sci ▾

Translate

**This automatic translation is provided for information only, it may contain discrepancies or mistakes and does not have any juridical value.**

- *Please hover your mouse over parallel segments of text*
- *Click to view other proposals*
- *Select words or phrases on the left to access other translation proposals*

本发明公开了一种多用途的园林维护设备，其结构包括移动维修机、轮胎、滚轴、底盘、开关控制器、推把；为了实现多用途的园林维护设备能够实现打药和洒水并且移动方便，可以修枝剪叶清理地面杂草和落叶，移动维修机下设有轮胎，便于移动，驱动机构可以带动剪切机构对园林的植物进行修枝剪叶，通过地面清理装置能够将地面的杂草和落叶收集到垃圾收集框内，浇水装置配合注水室可以将药水直接浇注到植物上，推动柱带动洒水机构能够对地面进行洒水，提高了工作效率。

the invention discloses a multipurpose garden maintenance device which structurally comprises a mobile maintenance machine, a rolling shaft, a chassis, a switch controller and a push handle; in order to realize multi-purpose garden maintenance equipment, insecticide and watering can be realized, and the multifunctional garden maintenance equipment is convenient to move., the pruning blade can be used for clearing away weeds and fallen leaves on the ground, and a tire is arranged below the mobile maintenance machine, and the driving mechanism can drive the shearing mechanism to perform pruning and leaf shearing on the plants of the garden., and weeds and fallen leaves on the ground can be collected into the garbage collecting frame through the ground cleaning device., the watering device is matched with the water injection chamber, so that the liquid medicine can be directly poured on the plant, the pushing column drives the watering mechanism to spray water on the ground, and the working efficiency is improved.

Edit translation

本发明公开了一种多用途的园林维护设备，其结构包括移动维修机、轮胎、滚轴、底盘、开关控制器、推把；为了实现多用途的园林维护设备能够实现打药和洒水并且移动方便，可以修枝剪叶、清理地面杂草和落叶，**移动**维修机下设有轮胎，便于移动，驱动机构可以带动剪切机构对园林的植物进行修枝剪叶，通过地面清理装置能够将地面的杂草和落叶收集到垃圾收集框内，洒水装置配合注水室可以将药水直接滴注到植物上，推动柱带动洒水机构能够对地面进行洒水，提高了工作效率。

Edit translation

lated links

- [WIPO Translate: Cutting-Edge Translation Tool For Patent Docume](#)

the invention discloses a multipurpose garden maintenance device which structurally comprises a mobile maintenance machine, a rolling shaft, a chassis, a switch controller and a push handle; in order to realize multi-purpose garden maintenance equipment, insecticide and watering can be realized, and the multifunctional garden maintenance equipment is convenient to move., **the pruning blade can be used for clearing away weeds and fallen leaves on the ground, and a tire is arranged below the mobile maintenance machine**, and the driving mechanism can drive the shearing

Choose among proposals, or edit the text

the pruning blade can be used for clearing away weeds and fallen leaves on the ground, and a tire is arranged below the mobile maintenance machine ...

Ok

the pruning blade can be used for clearing away weeds and fallen leaves on the ground, and a tire is arranged below the mobile maintenance machine

the pruning blade can be used for cleaning **the ground weeds and the fallen leaves**, and a tire is arranged below the mobile maintenance machine

the pruning blade can be used for cleaning **the ground weeds and the fallen leaves, and a tire is arranged under** the mobile maintenance machine

the pruning blade can be used for clearing away weeds and fallen leaves on the ground, and a tire is arranged **under** the mobile maintenance machine

the pruning blade can be used for cleaning **the ground weeds and fallen leaves**, and a tire is arranged below the mobile maintenance machine

the pruning blade can be used for cleaning **the ground weeds and the fallen leaves, and the tire is arranged below** the mobile maintenance machine

the pruning blade can be used for cleaning **the ground weeds and the fallen leaves, and the tire is arranged under** the mobile maintenance machine

the pruning blade can be used for cleaning **the ground weeds and fallen leaves, and a tire is arranged under** the mobile maintenance machine

the pruning blade can be used for clearing away weeds and fallen leaves on the ground, and **the tire is arranged below** the mobile maintenance machine

the pruning blade can be used for cleaning **the ground weeds and the fallen leaves, and a tire is arranged below the movable** maintenance machine

the pruning blade can be used for cleaning **ground weeds and fallen leaves**, and a tire is arranged below the mobile maintenance machine

the pruning blade can be used for cleaning **the ground weeds and the fallen leaves, and a tire is arranged under the movable** maintenance machine

the pruning **shears** can be used for clearing away weeds and fallen leaves on the ground, and a tire is arranged below the mobile maintenance machine

the pruning **shears can be used for cleaning the ground weeds and the fallen leaves**, and a tire is arranged below the mobile maintenance machine

the pruning blade can be used for clearing away weeds and fallen leaves on the ground, and a **t**(ire is arranged below the mobile maintenance machine

the pruning blade can be used for clearing away weeds and fallen leaves on the ground, and **the tire is arranged under** the mobile maintenance machine

the pruning blade can be used for clearing away weeds and fallen leaves on the ground, and a tire is arranged below the **movable** maintenance machine

the pruning **shears can be used for cleaning the ground weeds and the fallen leaves, and a tire is arranged under** the mobile maintenance machine

the pruning blade can be used for cleaning **ground weeds and fallen leaves, and a tire is arranged under** the mobile maintenance machine

WIPO Translate  
WIPO Pearl

# WIPO Pearl

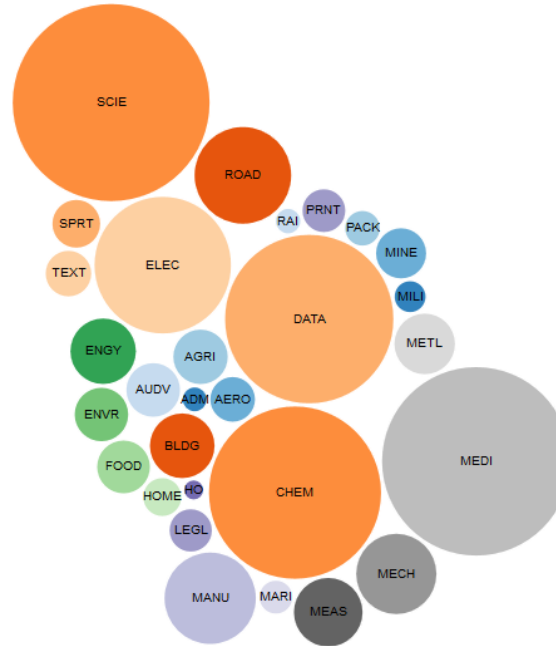

## WIPO Pearl - Linguistic Search

WIPO's multilingual terminology portal gives access to scientific and technical terms derived from patent documents. Search by term, with optional parameters. Select a Source Language for best results, and disable ad-blocking plug-ins.

- [User Guide](#)
- [Concept Map Search](#)

Search Term	<input type="text" value="Enter your term here..."/>	Source Language	<input type="text" value="Any"/>	Target Language	<input type="text" value="Any"/>
Subject Field	<input type="text" value="Any"/>	Abbreviation Only	<input type="checkbox"/>	Exact Search	<input type="checkbox"/>
<input type="button" value="Search"/> <input type="button" value="Reset"/>					

# WIPO Pearl

- WIPO's online terminology database
- 17'000 concepts, 160'000 terms
- 10 languages
- Contents validated by WIPO language experts and terminologists



# Example: bicycle fork

Search Term  Source Language  Target Language

Subject Field  Abbreviation Only  Exact Search

Results

1 HITS for bicycle fork Source Language EN; Target Language Any; Subject Field Any

1 of 1

ROAD / Cycles & non-powered vehicles

EN	bicycle fork	<input type="button" value="⊕"/>	<input type="button" value="🚩🚩🚩🚩🚩"/>	<input type="button" value="📄"/> <input type="button" value="🌐"/> <input type="button" value="📄"/>	<input type="button" value="★ ★ ★ ★ ★"/>
DE	Fahrradgabel	<input type="button" value="⊕"/>	<input type="button" value="🚩🚩🚩🚩🚩"/>	<input type="button" value="📄"/> <input type="button" value="🌐"/> <input type="button" value="📄"/>	<input type="button" value="★ ★ ★ ★ ★"/>
ES	horquilla	<input type="button" value="⊕"/>	<input type="button" value="🚩🚩🚩🚩🚩"/>	<input type="button" value="📄"/> <input type="button" value="🌐"/> <input type="button" value="📄"/>	<input type="button" value="★ ★ ★ ★ ★"/>
FR	fourche de bicyclette	<input type="button" value="⊕"/>	<input type="button" value="🚩🚩🚩🚩🚩"/>	<input type="button" value="📄"/> <input type="button" value="🌐"/> <input type="button" value="📄"/>	<input type="button" value="★ ★ ★ ★ ★"/>
KO	포크	<input type="button" value="⊕"/>	<input type="button" value="🚩🚩🚩🚩🚩"/>	<input type="button" value="📄"/> <input type="button" value="🌐"/> <input type="button" value="📄"/>	<input type="button" value="★ ★ ★ ★ ★"/>
PT	garfo	<input type="button" value="⊕"/>	<input type="button" value="🚩🚩🚩🚩🚩"/>	<input type="button" value="📄"/> <input type="button" value="🌐"/> <input type="button" value="📄"/>	<input type="button" value="★ ★ ★ ★ ★"/>
ZH	自行车前叉 (zìxíngchē qiánchā)	<input type="button" value="⊕"/>	<input type="button" value="🚩🚩🚩🚩🚩"/>	<input type="button" value="📄"/> <input type="button" value="🌐"/> <input type="button" value="📄"/>	<input type="button" value="★ ★ ★ ★ ★"/>
JA	自転車フォーク		WIPO MT	<input type="button" value="📄"/>	<input type="button" value="★ ★ ★ ★ ★"/>
RU	Вилки велосипеда		WIPO MT	<input type="button" value="📄"/>	<input type="button" value="★ ★ ★ ★ ★"/>

1 of 1

Results

Concept Map

Subject Field ROAD (Road Vehicle & Automotive Engineering)

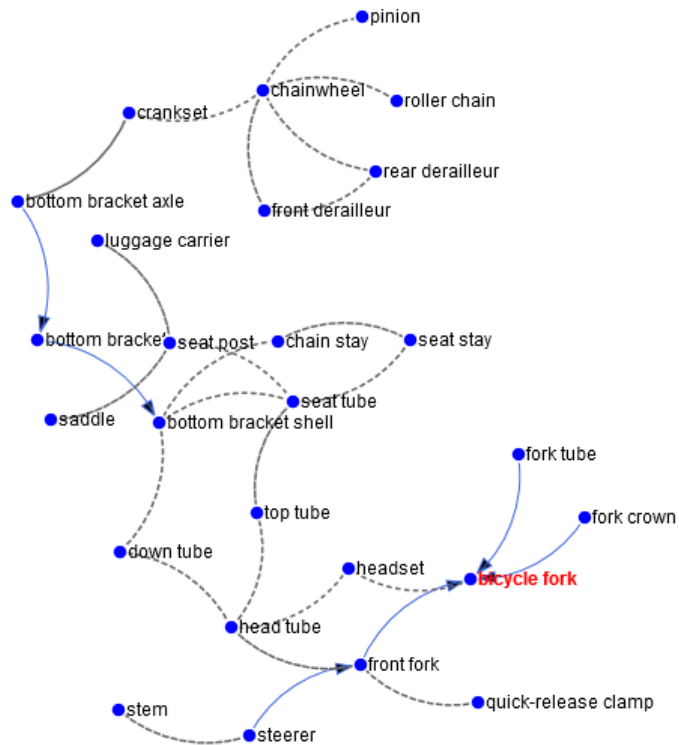

Subfield Cycles & non-powered vehicles

\*\*\* Associative relation between two concepts — Generic or partitive relation between two concepts ● Concept belongs to a different subject field/subfield



- Browse by Week (PCT)**
- Gazette Archive
- National Phase Entries ▶
- Sequence listing
- IPC Green Inventory
- Portal to patent registers

# Weekly PCT publication

45/2018 (08.11.2018)  

1 2 3 4 5 6 7 8 9 10 >> >>>

Title	Kind	Appl.No	IPC	Applicant
1. (WO/2018/202135) RESOURCE SHARING BETWEEN PDCCH AND PDSCH	Initial Publication with ISR[A1]	CN2018/085616	H04W 72/04	MEDIATEK INC.
2. (WO/2018/202136) DATA TRANSMISSION METHOD AND DEVICE	Initial Publication with ISR[A1]	CN2018/085621	H04L 1/18	HUAWEI TECHNOLOGIES CO., LTD.
3. (WO/2018/202138) COMMUNICATION METHOD AND RELATED DEVICE	Initial Publication with ISR[A1]	CN2018/085630	H04W 8/24	HUAWEI TECHNOLOGIES CO., LTD.
4. (WO/2018/202139) SOUNDING REFERENCE SIGNAL DESIGN IN MOBILE COMMUNICATIONS	Initial Publication with ISR[A1]	CN2018/085633	H04L 5/00	MEDIATEK INC.
5. (WO/2018/202140) ENCODING METHOD, DEVICE AND APPARATUS	Initial Publication with ISR[A1]	CN2018/085635	H04L 1/00	HUAWEI TECHNOLOGIES CO., LTD.
6. (WO/2018/202141) METHOD, DEVICE AND SYSTEM FOR SERVICE RESTORATION, STORAGE MEDIUM AND PROCESSOR	Initial Publication with ISR[A1]	CN2018/085637	H04L 12/703	ZTE CORPORATION
7. (WO/2018/202142) SEQUENCE DETERMINING	Initial Publication with ISR[A1]	CN2018/085645	H03M 13/13	ZTE CORPORATION

# IPC Statistics

Most active

Most active last 5 gazettes

Most advanced

Breakouts

Gazette: 2018-11-08

IPC Code	No	Action
G06F 17/30 <a href="#">?</a>	1499	<a href="#">Chart Query</a>
A61P 35/00 <a href="#">?</a>	1225	<a href="#">Chart Query</a>
H04W 72/04 <a href="#">?</a>	1210	<a href="#">Chart Query</a>
H04L 29/06 <a href="#">?</a>	1199	<a href="#">Chart Query</a>
A61B 5/00 <a href="#">?</a>	1032	<a href="#">Chart Query</a>
H04L 5/00 <a href="#">?</a>	878	<a href="#">Chart Query</a>
H04L 29/08 <a href="#">?</a>	874	<a href="#">Chart Query</a>
G06K 9/00 <a href="#">?</a>	850	<a href="#">Chart Query</a>
G06F 3/01 <a href="#">?</a>	682	<a href="#">Chart Query</a>
C12Q 1/68 <a href="#">?</a>	670	<a href="#">Chart Query</a>

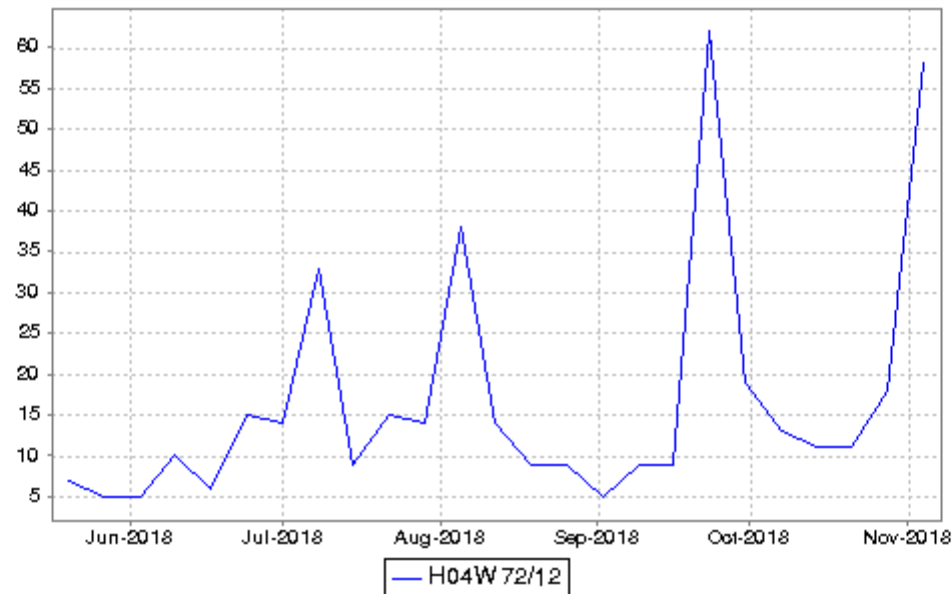

- Browse by Week (PCT)
- Gazette Archive
- National Phase Entries ▶
- Sequence listing
- IPC Green Inventory
- Portal to patent registers

# Gazette Archive

## PCT Publications - Gazettes Archive

2018



Download	Publication Date	Count	
01/2018	04.01.2018	6249	<a href="#">View</a>
02/2018	11.01.2018	3997	<a href="#">View</a>
03/2018	18.01.2018	4257	<a href="#">View</a>
04/2018	25.01.2018	4106	<a href="#">View</a>
05/2018	01.02.2018	5226	<a href="#">View</a>
06/2018	08.02.2018	4286	<a href="#">View</a>

- Browse by Week (PCT)
- Gazette Archive
- National Phase Entries ▶
- Sequence listing
- IPC Green Inventory
- Portal to patent registers



# National Phase Entries

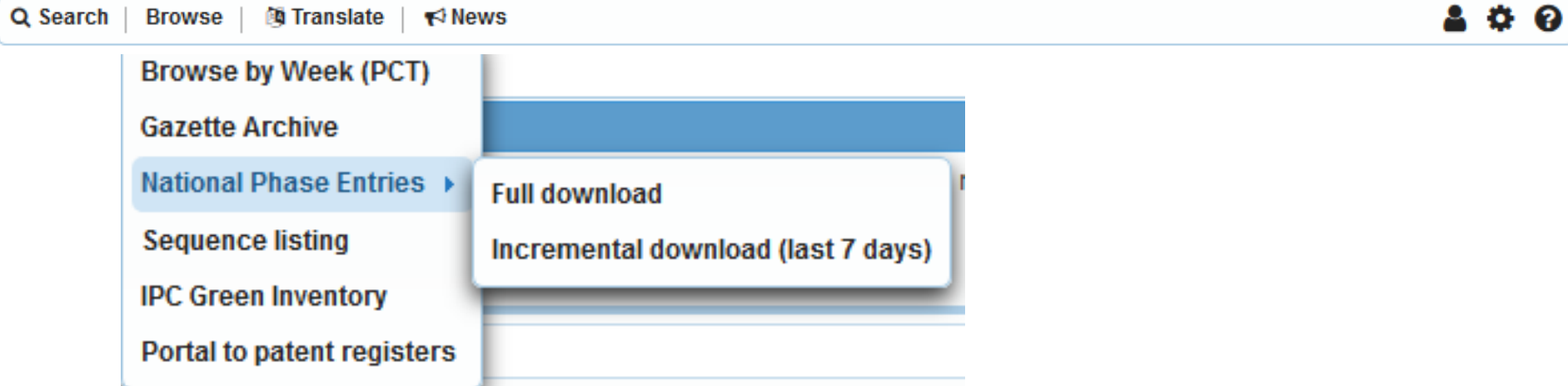

- Browse by Week (PCT)
- Gazette Archive
- National Phase Entries ▶
- Sequence listing**
- IPC Green Inventory
- Portal to patent registers

# Sequence Listing

## Search Sequence Listings

Published Nucleotide and/or Amino Acid Sequence Listings Contained in Published PCT Applications (WinZIP 8.0)

This data is also available for bulk download via anonymous ftp from [ftp://ftp.wipo.int/pub/published\\_pct\\_sequences/publication/](ftp://ftp.wipo.int/pub/published_pct_sequences/publication/).

Year:

2018 ▾

Publication Week:

November 08, 2018 ▾

Publication Date:

WoNumber	Size	Download	Applicant
<a href="#">WO18/201260</a>	0 KBs	<a href="#">SL1.zip</a>	OTTAWA HEART INSTITUTE RESEARCH CORPORATION
<a href="#">WO18/201516</a>	1 KBs	<a href="#">SL1.zip</a>	TSINGHUA UNIVERSITY
<a href="#">WO18/201754</a>	3 KBs	<a href="#">SL1.zip</a>	TIANJIN KERNEL AGRICULTURAL SCIENCE AND TECHNOLOGY CORPORATION LTD. CUCUMBER RESEARCH INSTITUTE
<a href="#">WO18/201754</a>	3 KBs	<a href="#">SL2.zip</a>	TIANJIN KERNEL AGRICULTURAL SCIENCE AND TECHNOLOGY CORPORATION LTD. CUCUMBER RESEARCH INSTITUTE
<a href="#">WO18/201794</a>	7 KBs	<a href="#">SL1.zip</a>	CHONGQING PRECISION BIOTECH COMPANY LIMITED
<a href="#">WO18/202199</a>	21 KBs	<a href="#">SL1.zip</a>	INSTITUTE OF GENETICS AND DEVELOPMENTAL BIOLOGY, CHINESE ACADEMY OF SCIENCES
<a href="#">WO18/202200</a>	5 KBs	<a href="#">SL1.zip</a>	ELIXIRON IMMUNOTHERAPEUTICS INC.
<a href="#">WO18/202578</a>	3 KBs	<a href="#">SL1.zip</a>	FIRMENICH SA
<a href="#">WO18/202669</a>	1 KBs	<a href="#">SL1.zip</a>	RHEINISCH-WESTFÄLISCHE TECHNISCHE HOCHSCHULE (RWTH) AACHEN
<a href="#">WO18/202723</a>	0 KBs	<a href="#">SL1.zip</a>	FUNDACIÓ INSTITUT D'INVESTIGACIÓ EN CIÈNCIES DE LA SALUT GERMANS TRIAS I PUJOL
<a href="#">WO18/202740</a>	0 KBs	<a href="#">SL1.zip</a>	UNIVERSITAT DE BARCELONA
<a href="#">WO18/202792</a>	0 KBs	<a href="#">SL1.zip</a>	INSERM (INSTITUT NATIONAL DE LA SANTÉ ET DE LA RECHERCHE MÉDICALE)
<a href="#">WO18/202794</a>	1 KBs	<a href="#">SL1.zip</a>	B CELL DESIGN
<a href="#">WO18/202800</a>	10 KBs	<a href="#">SL1.zip</a>	KWS SAAT SE
<a href="#">WO18/202846</a>	2 KBs	<a href="#">SL1.zip</a>	NOVOZYMES A/S
<a href="#">WO18/202850</a>	11 KBs	<a href="#">SL1.zip</a>	INSERM (INSTITUT NATIONAL DE LA SANTÉ ET DE LA RECHERCHE MÉDICALE)

- Browse by Week (PCT)
- Gazette Archive
- National Phase Entries ▶
- Sequence listing
- IPC Green Inventory
- Portal to patent registers

# IPC Green Inventory



## INTERNATIONAL PATENT CLASSIFICATION (IPC)

- Browse the IPC
- Overview
- About the IPC
- ▶ IPC Green Inventory
- Download and IT Support
- IPC E-Forum
- Meetings
- FAQ
- Contact

## RELATED LINKS

- PATENTSCOPE
- Other Classifications
- WIPO Standards and Handbook

## IPC Green Inventory

1. The "IPC Green Inventory" was developed by the IPC Committee of Experts in order to facilitate searches for patent information relating to so-called Environmentally Sound Technologies (ESTs), as listed by the [United Nations Framework Convention on Climate Change \(UNFCCC\)](#).
2. ESTs are currently scattered widely across the IPC in numerous technical fields. The Inventory attempts to collect ESTs in one place, although it should be noted that the Inventory does not purport to be fully exhaustive in its coverage.
3. ESTs are presented in a hierarchical structure. Clicking on the  sign opens the hierarchy of the relevant technology. For each technology, the links in the IPC column direct the user to the corresponding place in the scheme.
4. It should be noted that each EST and its corresponding IPC place(s) do not necessarily coincide and that the EST may represent a subset of the corresponding IPC place.
5. The links in the PATENTSCOPE column allow the user to automatically search and display all international patent applications available through PATENTSCOPE which are classified in the relevant IPC place. In view of paragraph 4, above, search results may additionally include irrelevant results not relating to ESTs.
6. For IPC place ranges (e.g. Fuel cells H01M 4/86-4/98), the search result is limited to the first symbol of the range (e.g. H01M 4/86). If searching additional symbols falling in the range is desirable, this can be done either manually in PATENTSCOPE or via the IPC scheme by using the "bridge" function ("magnifying lens"  button).

TOPIC	IPC	PATENTSCOPE
☐ ALTERNATIVE ENERGY PRODUCTION		
☐ Bio-fuels		
. Integrated gasification combined cycle (IGCC)	<a href="#">C10L 3/00</a> <a href="#">F02C 3/28</a>	<a href="#">C10L 3/00</a> <a href="#">F02C 3/28</a>
☐ Fuel cells	<a href="#">H01M 4/86-4/98, 8/00-8/24, 12/00-12/08</a>	<a href="#">H01M 4/86-4/98, 8/00-8/24, 12/00-12/08</a>
. Pyrolysis or gasification of biomass	<a href="#">C10B 53/00</a> <a href="#">C10J</a>	<a href="#">C10B 53/00</a> <a href="#">C10J</a>
☐ Harnessing energy from manmade waste		
☐ Hydro energy		
. Ocean thermal energy conversion (OTEC)	<a href="#">F03G 7/05</a>	<a href="#">F03G 7/05</a>
☐ Wind energy	<a href="#">F03D</a>	<a href="#">F03D</a>

- Browse by Week (PCT)
- Gazette Archive
- National Phase Entries ▶
- Sequence listing
- IPC Green Inventory
- Portal to patent registers**

# Portal to patent registers

## Patent Register Portal

The Patent Register Portal is your gateway to online patent registers and gazettes and to legal-status-related information from over 200 jurisdictions and patent information collections. Use it as a first step to identify what information can be retrieved online and how to access it.

[Contact us](#) with any suggestions for improvements or updates.

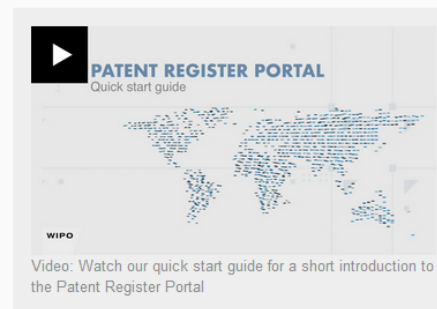

Map view

Map view with filters

Table overview

Detailed jurisdiction files

Online Register

Online Gazette

English Interface

PCT Application/Publication Number

Inventor/Applicant Name

Priority Data

Fee Payment



Jurisdictions that have an online patent register

Online Register

Yes

No

No data available

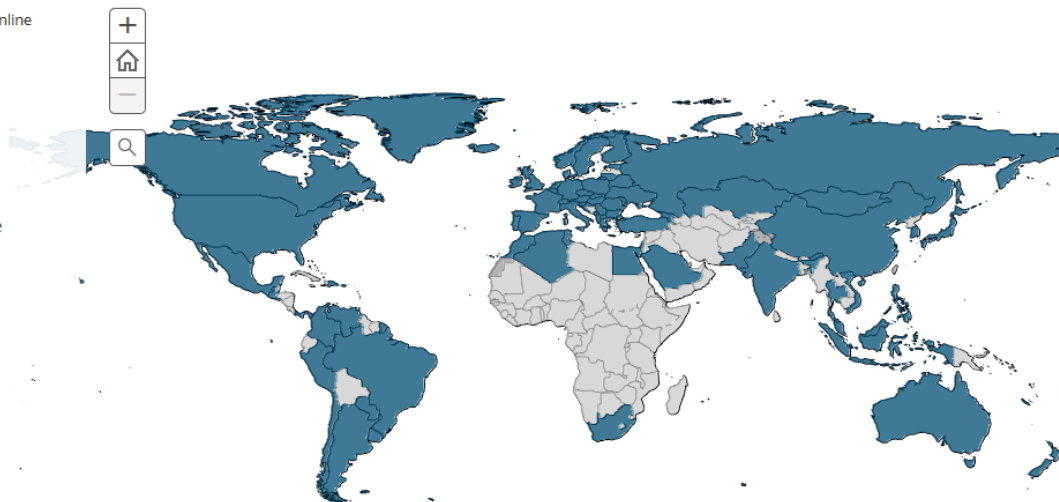

# Searches

The screenshot displays the top navigation bar of the WIPO search portal. The navigation menu includes 'Search', 'Browse', 'Translate', and 'News'. On the right side of the bar are icons for user profile, settings, and help. A dropdown menu is open under the 'Search' button, listing the following options: 'Simple', 'Advanced Search', 'Field Combination', 'Cross Lingual Expansion', and 'Chemical compounds (login required)'. The 'Chemical compounds (login required)' option is highlighted with a light purple background. Below the navigation bar, a blue banner indicates that the database contains '2 million patent documents including 3.5 million published international patent applications (PCT). Detailed coverage'. A search input field is visible with a question mark icon and the text 'Office:All'. To the right of the input field is a 'Search' button. At the bottom of the page, a partial text snippet reads: 'PCT Publication 45/2040 (00 44 2040) is now available. The next publication date is scheduled as follows: Class number 40/2040 (45 44 2040) ...'.



# The concept

- Recognize the names of chemical compounds in patent texts and their structures from embedded drawings included in patent texts
- Standardize all the different representations of chemical structures into InChIkeys
- Implement search functions using InChIkeys that can be used by non chemists

# InChIkeys

- Definition: a short, fixed-length character signature based on a hash code of the InChI string.

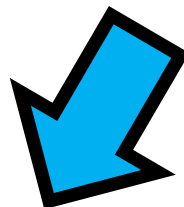

- InChIkeys provide a precise, robust, IUPAC\* approved structure-derived tag for a chemical substance.

\*[International Union of Pure and Applied Chemistry](#)

# Example: InChI – InChIKey for aspirin

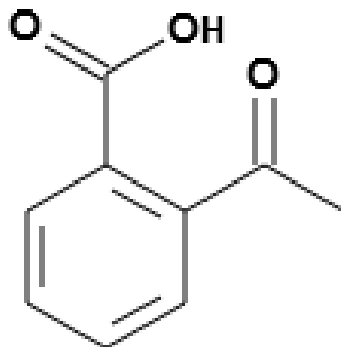

InChI: InChI=1S/C9H8O4/c1-6(10)13-8-5-3-2-4-7(8)9(11)12/h2-5H,1H3,(H,11,12)  
InChIKey: BSYNRYMUTXBXSQ-UHFFFAOYSA-N

**InChIKey** = a fixed-length (27-character) condensed digital representation of an **InChI**

**InChI** = is a textual identifier developed to make it easy to perform web searches for chemical structures

# Scope

- Works on **developed exact formulas**  $\neq$  Markush structures (-R) that are chemical symbols used to indicate a collection of chemicals with similar structures.

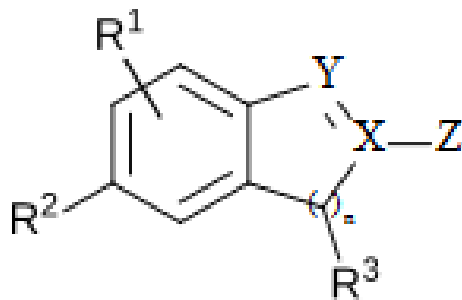

# Limitations

- Long automated procedures, no supervision
- Will not recognize 100%! Same drawbacks as the OCR
- Depends on OCR quality for PCT applications
- Does not work with simple formulas such H<sub>2</sub>O
- Not all collections and related languages

# Why is it useful?

- Common names such as “aspirin”, “paracetamol” might not be used in patent documents
- There are many ways of representing formulas

# How does it work?

WORLD INTELLECTUAL PROPERTY ORGANIZATION

Q Search | Browse | Translate | News

sandrine.ammann@wipo.int

Home ▶ IP Services ▶ PATENTSCOPE

### Chemical compounds search

[Help]

Convert structure | Structure editor | SubStructure | Upload structure

Compound name ▼ Type an accepted name, commercial name, CAS name, IUPAC name

Search for scaffold:  Office:  All

Tooltip Help

Exact Structure Search | Show in editor | Reset

# 3 options

Chemical compounds search [Help]

**Convert structure** | Structure editor | SubStructure | Upload structure

Compound name  Type an accepted name, commercial name, CAS name, IUPAC name

**Search for scaffold:**  Office:  All

Tooltip Help



# Scaffold

- Basic skeleton of a molecule to which further groups and moieties are attached

# Upload a structure

Chemical compounds search [Help]

Convert structure   Structure editor   SubStructure   **Upload structure**

Select a structure file (MOL) or image file (PNG, GIF, TIFF, JPEG) and upload it.

Search for scaffold:    Office:  All

Tooltip Help

# Example

Chemical compounds search [\[Help\]](#)

Structure editor | Convert structure | **Upload structure**

Select a structure file (MOL) or image file (PNG, GIF, TIFF, JPEG) and upload it.

chemical\_formula.png

Search for scaffold:  Office: All [Specify ⇌](#)

Tooltip Help

Structure editor

Convert structure

Upload structure

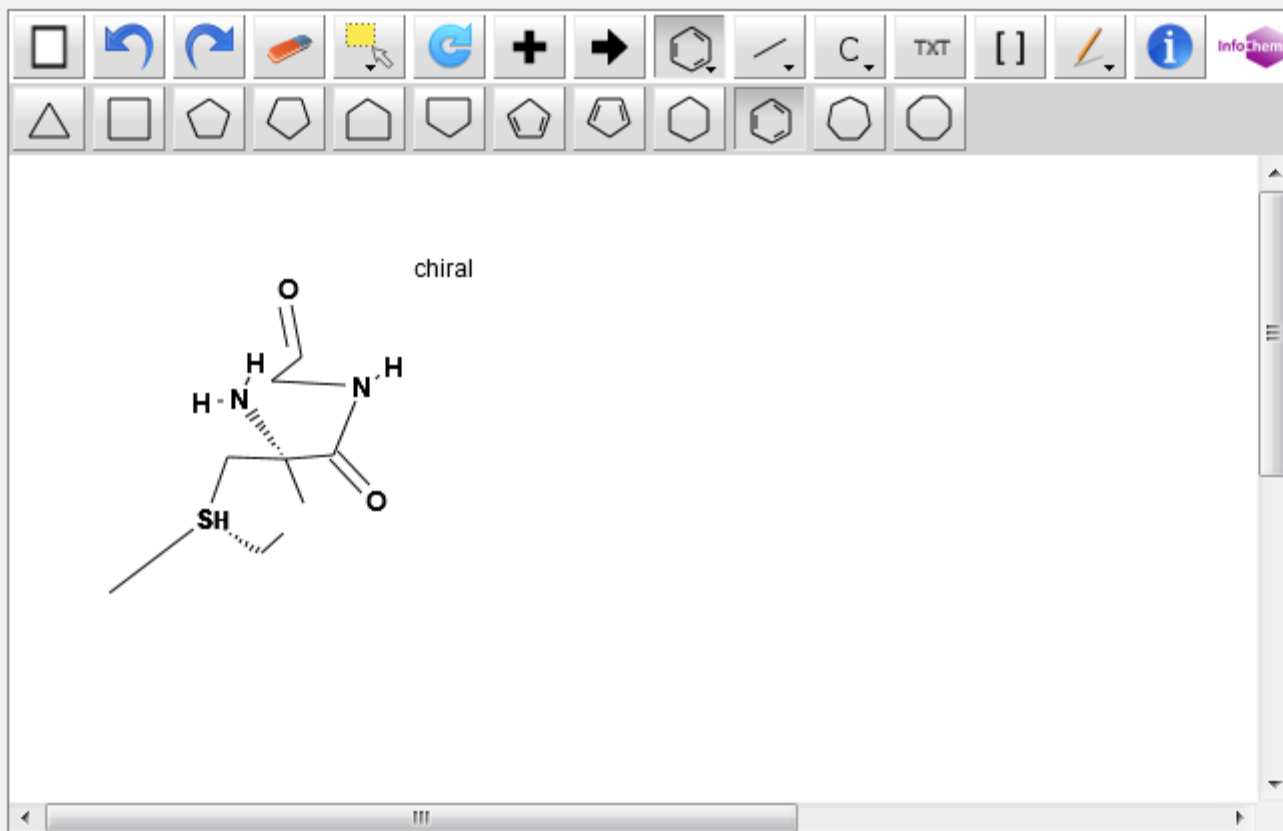

InChI: InChI=1S/C9H20N2O2S/c1-4-14(3)7-9(2,10)8(13)11-5-6-12/h6,14H,4-5,7,10H2,1-3H3,(H,11,13)/t9-m/s1

InChIKey: MWSZUBUMBNLJX-SECBINFHSA-N

Molecular Formula: C9H20N2O2S

Molecular Weight: 220.3358 g/mol

Search

Reset

Search for scaffold: Office: All [Specify](#)

# Structure editor

Chemical compounds search [Help]

Convert structure   **Structure editor**   SubStructure   Upload structure

Search for scaffold:  Office:  All

Tooltip Help    Evaluate   Exact Structure Search   Substructure Search   Reset

InfoChem

# Example

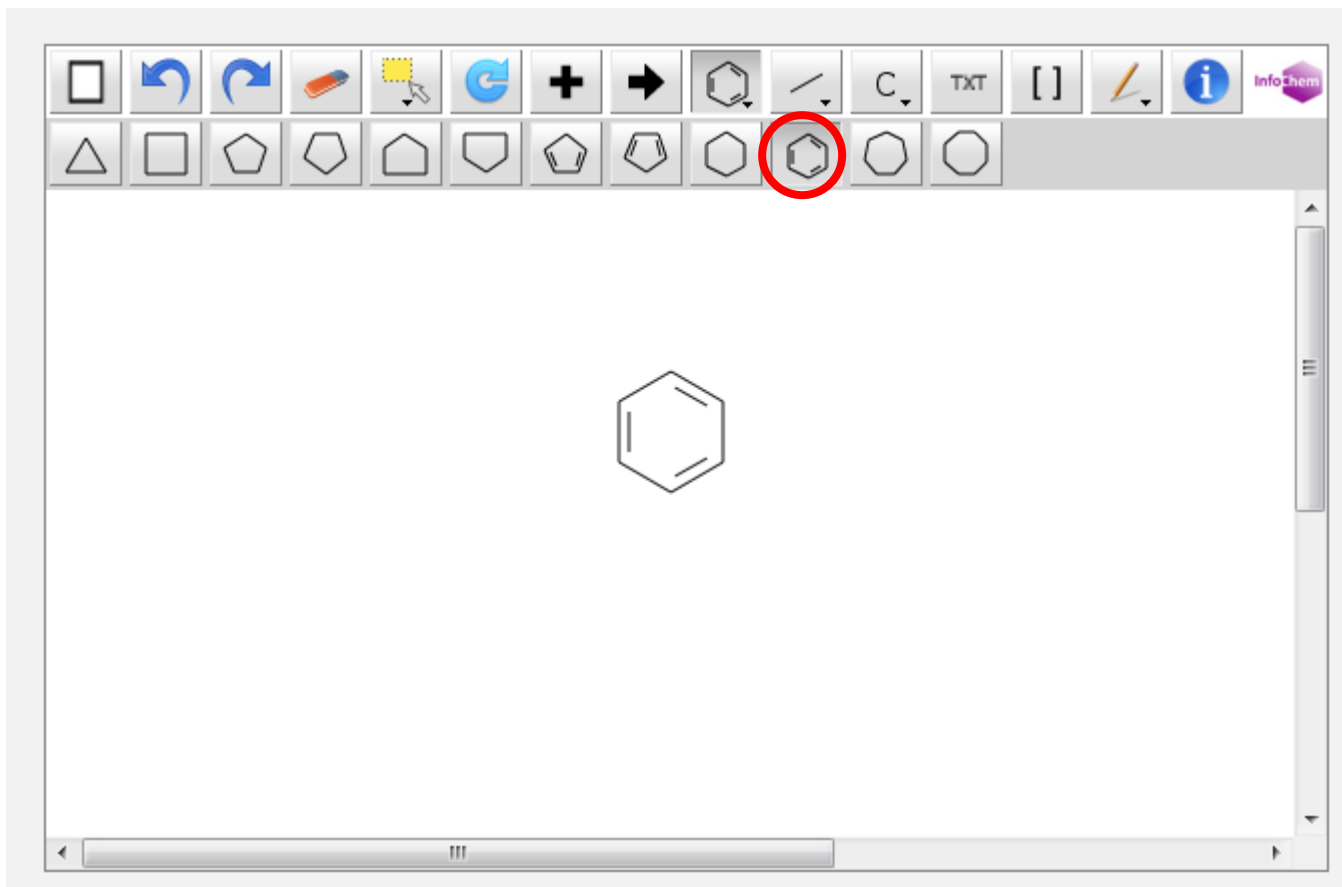

# Convert a structure

Chemical compounds search [Help]

**Convert structure** | Structure editor | SubStructure | Upload structure

Compound name

Search

Tools

- Compound name
- INN
- InChI
- SMILES

# Convert structure: ex.: paracetamol

Chemical compounds search [Help]

**Convert structure** | Structure editor | SubStructure | Upload structure

Compound name

Search for scaffold:  Office:  All

Tooltip Help

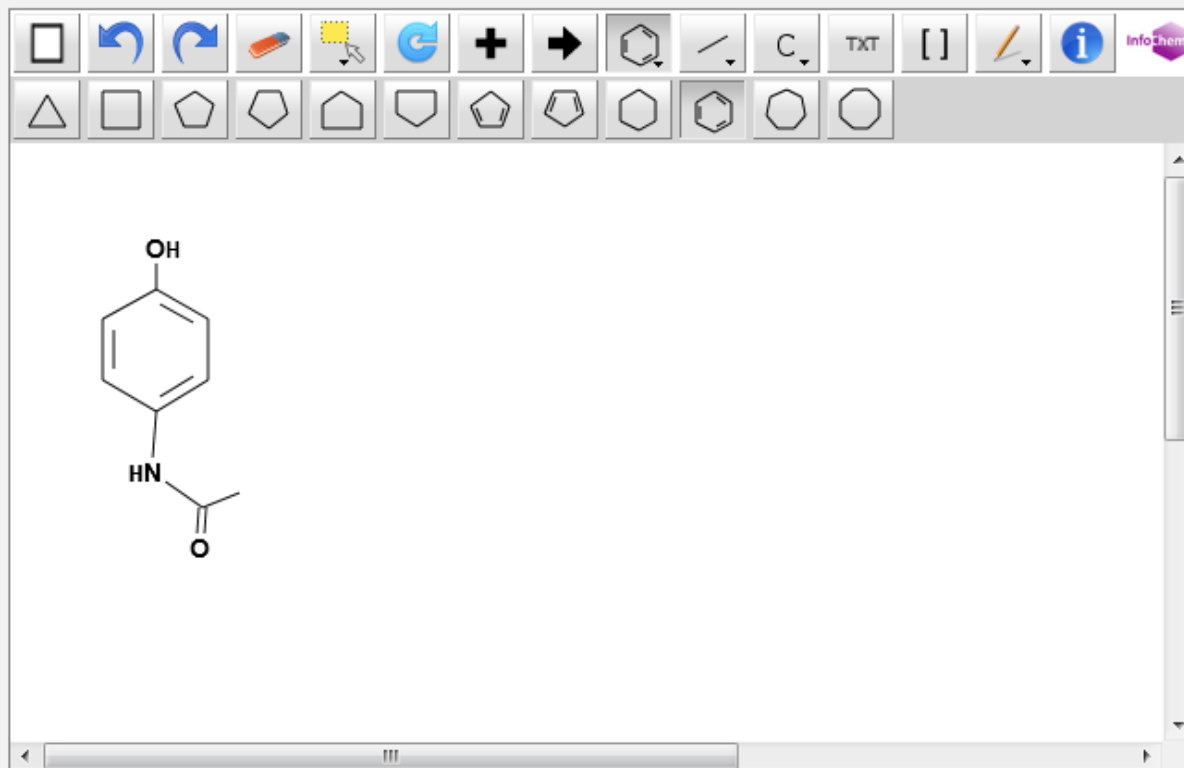

Structure editor

[Convert structure](#)[Upload structure](#)

**InChI:** InChI=1S/C8H9NO2/c1-6(10)9-7-2-4-8(11)5-3-7/h2-5,11H,1H3,(H,9,10)  
**InChIKey:** RZVAJINKPMORJF-UHFFFAOYSA-N  
**Molecular Formula:** C8H9NO2  
**Molecular Weight:** 151.1649 g/mol

[Search](#)[Reset](#)Search for scaffold: Office: All [Specify ⇌](#)Tooltip Help

Refine Search

CHEM:(RZVAJINKPMORJF-UHFFFAOYSA-N)

 RSS

## Analysis

Sort by: View List Length  Side-by-side

Int.Class	Appl.No	Title	Applicant	Ctr	PubDate
			Inventor		
1. 103012186	C07C 233/25	一种用吸附树脂从精母液中回收扑热息痛的方法	西安蓝晓科技新材料股份有限公司	CN	03.04.2013
	 201210566903.7			郭福民	

本发明公开了一种用吸附树脂从生产扑热息痛精母液里回收扑热息痛的方法,包括下述步骤:a、扑热息痛精制工序中产生的精母液以0.1-30BV/h的速度通过大孔吸附树脂来富集精母液中的扑热息痛,直至吸附饱和;b、用醋酸溶液以0.1-30BV/h的流速对步骤a中吸附饱和的大孔吸附树脂进行解析;c、将步骤b中所得的解析液通过干燥、结晶后得到的白色固体即为扑热息痛。该方法具有降低能耗,工艺简单,操作容易,回收率高的优点。

### 2. 106562935 Colored spray coating liquid and acetaminophen colored cartoon orally disintegrating tablet for 3D printing, and preparation method thereof

A61K 9/20	 201610847287.0	广东药科大学	杨帆	CN	19.04.2017
-----------	--	--------	----	----	------------

The invention provides colored spray coating liquid and an acetaminophen colored cartoon orally disintegrating tablet for 3D (3-Dimension) printing, and a preparation method thereof. The colored spray coating liquid for 3D printing can be combined with medicine powder for spray coating printing, and the medicine powder is jointly mixed to be printed into a colored 3D finished product. The colored cartoon orally disintegrating tablet is prepared by a 3D printing technology. Compared with a conventional pharmaceutical method, the preparation method has the advantages that the preparation process is simple; the processes of preparing a special-shaped sheet stamping die, preparing particles, performing heating drying and the like are not needed; the cartoon shape and the tablet color can be freely regulated according to the fondness of children; and the compliance of children patients is greatly improved.

### 3. 107282017 Preparation method of kaolinite-humic acid composite colloid for absorbing acetaminophen

B01J 20/24	 201710683268.3	BAOJI UNIVERSITY OF ARTS AND SCIENCES	ZHAO YUE	CN	24.10.2017
------------	--	---------------------------------------	----------	----	------------

The invention discloses a preparation method of kaolinite-humic acid composite colloid for absorbing acetaminophen. The kaolinite-humic acid composite colloid is prepared by taking kaolinite and humic acid as a main raw material, mixing the humic acid colloid solution with quantified montmorillonite, and performing a series of post treatment steps with specific parameters. Through specific technical parameters, the kaolinite is organically compounded with humic acid together to obtain the absorbent material taking kaolinite as a wall material and the humic acid as the core material. The kaolinite-humic acid composite colloid has very high specific area and special charge property, and can provide enough absorbing site, thereby increasing the absorption capacity of the acetaminophen.

PCT Biblio. Data

Description

Claims

National Phase

Notices

**Compound**

Drawings

Documents

Title

Abstract

**Description**

Claims

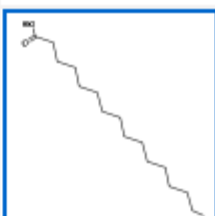
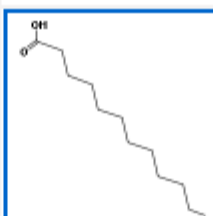
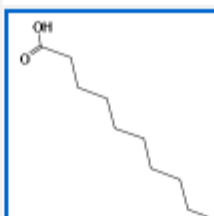
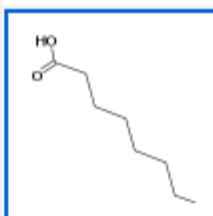
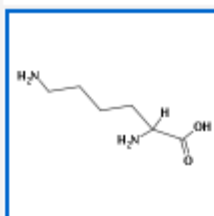
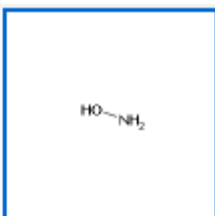
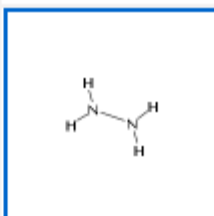
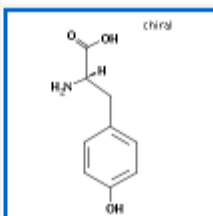
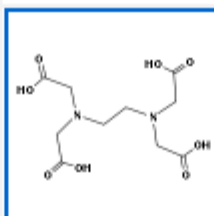
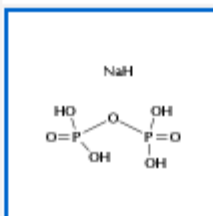
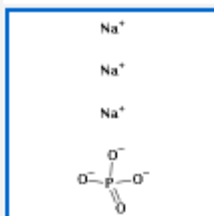
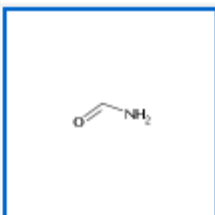
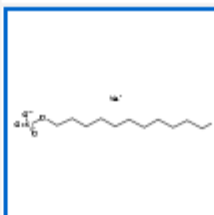
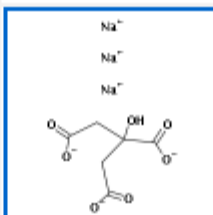
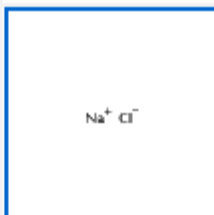
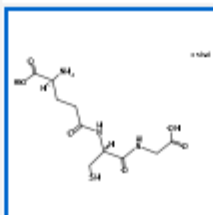
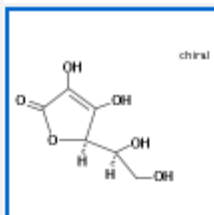
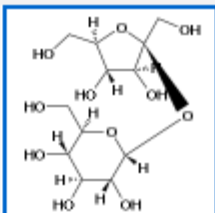
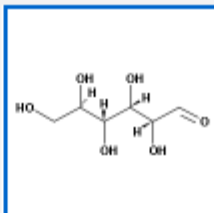
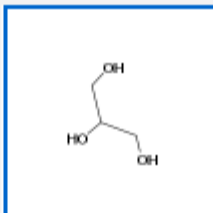
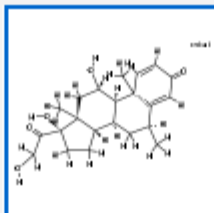
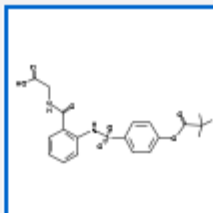
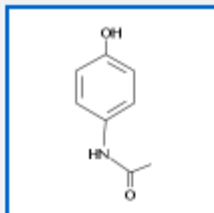

Lysine Lysine

Octanoic acid  
Octanoic acid

1 2 3 4 5 6

The compound may optionally comprise or consist of any of the compounds or classes of compounds mentioned herein, e.g. any of the biomarkers mentioned herein. Optionally, it may comprise or consist of, for example, a lipid, such as, a glycolipid or phospholipid; carbohydrate; DNA; RNA; protein; polypeptide, such as, a ribosomal peptide or a non-ribosomal peptide; oligopeptide; lipoprotein; lipopeptide; amino acid; and/or chemical molecule, optionally an organic chemical molecule.

The compound may optionally be linear, cyclic or branched.

The compound may optionally be a metabolite, such as, a primary or a secondary metabolite; an antibiotic; a quorum sensing molecule; a fatty acid synthase product; a pheromone; and/or a biopolymer.

The compound may optionally be characterised by one or more of the following functional groups: alcohol, ester, alkane, alkene, alkyne, ether, ketone, aldehyde, anhydride, amine, amide, nitrile, aromatic, carboxylic acid, alkyl halide, and/or carbonyl. Optionally, it may additionally be identified as being primary, secondary or tertiary, e.g., a primary alcohol, a secondary amine, or the like.

Optionally, the compound may be a therapeutic drug, an illicit drug, a doping agent, and/or a metabolite or derivative of any thereof.

It may optionally be selected, e.g., from any of the drugs or agents mentioned herein, and/or Mescaline, PCP (Phencyclidine), Psilocybin, LSD, Heroin, Morphine, Codeine, dextroamphetamine, bupropion, cathinone, lisdexamfetamine, Allobarbitol, Alphenal (5-allyl-5-phenylbarbituric acid), Amobarbitol, Aprobarbitol, Brallobarbitol, Butobarbitol, Butalbital, Cyclobarbitol, Methylphenobarbitol, Mephobarbitol, Methohexital, Pentobarbitol, Phenobarbitol, Secobarbitol, Talbutal, Thiamylal, and/or Thiopental.

Ranitidine, phenylalanine PKU, dimethylamylamine, cocaine, diazepam,

androstadienedione, stigmastadienone, androsteronehemisuccinate, 5 $\alpha$ -androstan-3 $\beta$ , 17 $\beta$ -diol-16-one, androsterone glucuronide, epitestosterone, 6-dehydrocholestenone, phenylalanine, leucine, valine, tyrosine, methionine, sitamaquine, terfenadine, prazosin, methadone, amitriptyline, nortriptyline, pethidine, DOPA, ephedrine, ibuprofen, propranolol, atenolol, acetaminophen, bezethonium, citalopram, dextrophan, paclitaxel, proguanil,

simvastatin, sunitinib, telmisartan, verapamil, amitriptyline, pazopanib, tamoxifen, imatinib, cyclophosphamide, irinotecan, docetaxel, topotecan, acylcarnitines (C2-C18), nicotine, cotinine, trans-3-hydroxycotinine, anabasine, amphetamine, amphetamine-like stimulants, methamphetamine, MDA, MDMA, MDEA, morphine, A<sup>9</sup>-THC, tacrolimus, benzethonium, meprobamate, O-desmethyl-c/s-tramadol, carisoprodol, tramadol, nordiazepam, EDDP, norhydrocodone, hydromorphone, codeine, temazepam, noroxycodone, alprazolam, oxycodone, buprenorphine, norbuprenorphine, fentanyl, propoxyphene, 6-monoacetylmorphine, caffeine, carbadox, carbamazepine, digoxigenin, diltiazem, diphenhydramine, propranolol, sulfadiazine, sulfamethazine, sulfathiazole, thiabendazole, ketamine, norketamine, BZE, AMP, MAMP, and/or 6-MAM.

# Search example: Theobromine

- Its chemical formula is  $C_7H_8N_4O_2$  and IUPAC name: 3,7-dimethyl-1*H*-purine-2,6-dione
- Theobromine is found in the seeds of the plant *Theobroma Cacao*, which is the well-known source of chocolate and cocoa. It has a bitter flavor, which gives dark chocolate its typical bitter taste.

## Chemical compounds search

[Help]

Convert structure

Structure editor

SubStructure

Upload structure

Compound name



theobromine|

Search for scaffold:

Office:



All

Tooltip Help

Exact Structure Search

Show in editor

Reset

Convert structure

Structure editor

SubStructure

Upload structure

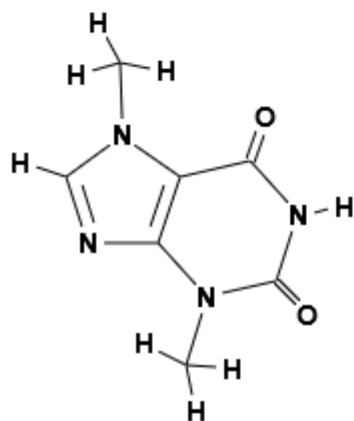

InChI: InChI=1S/C7H8N4O2/c1-10-3-8-5-4(10)6(12)9-7(13)11(5)2/h3H,1-2H3,(H,9,12,13)  
InChIKey: YAPQBXQYLJRXSA-UHFFFAOYSA-N  
Molecular Formula: C7H8N4O2  
Molecular Weight: 180.167 g/mol

Search for scaffold:  Office:  All

Refine Search CHEM:(YAPQBXYLJRXSA-UHFFFAOYSA-N)

Search



## Analysis

Countries		IPC		Inventor		Applicant		Pub Date	
Name	No	Name	No	Name	No	Name	No	Date	No
United States	9,141	A61K	22,658	Zablocki Jeff	118	MERCK SHARP & DOHME CORP.	753	1993	63
PCT	6,721	C07D	13,843	Mammen Mathai	111	MERCK & CO., INC.	614	1994	77
Japan	4,816	A61P	11,763	KUDUK, Scott, D.	85	Merck Sharp & Dohme Corp.	477	1995	106
China	2,767	C07C	2,057	Lindsley Craig W.	77	MERCK PATENT GMBH	459	1996	140
European Patent Office	2,127	A61Q	1,991	Coleman Paul J.	73	MERCK SHARP & DOHME	263	1997	172
		C07K	1,527	Kamboj Rajender	73	GENENTECH, INC.	226	1998	186
Republic of Korea	1,452	A01N	1,160	Elzein Elfatih	72	Theravance, Inc.	225	1999	188
EAPO	439	C12N	1,158	Stafford Jeffrey A.	71	Merck & Co. Inc.	208	2000	262

Sort by: Relevance

View All

List Length 10

Machine translation

 Side-by-side

Int.Class	Title	Ctr	PubDate
	Appl.No	Applicant	Inventor

## 1. 101939321 Production method and production device for composition having high content of theobromine

CN 05.01.2011

C07D 473/10

200980104250.7

Meiji Seika Kaisha

Satoshi Hanamura

Provided is a method for efficiently producing a composition having a high content of theobromine with a simple method. A method for producing a composition containing theobromine is characterized by comprising the steps of: (a) obtaining a crude theobromine extraction liquid through extraction from a plant body containing theobromine or a processed material thereof with a solvent; (b) bringing the crude theobromine extraction liquid into contact with a cation exchange resin which has been replaced with hydrogen ions in advance thereby adsorbing the theobromine onto the cation exchange resin; and subsequently, (c) passing a solvent which does not contain ionic substances through the cation exchange resin thereby obtaining a theobromine extraction liquid.

## 2. 105189736 适用于提高胎儿体重增加并增强骨特性的可可碱组合物

CN 23.12.2015

C12N 5/02

201480025405.9

斯欧考普控股公司

A-赛之霍普尔

提供了用可可碱培养细胞的组合物和方法, 以及由此得到的细胞。还提供了可可碱组合物, 这些可可碱组合物用于增强骨形成、增加骨密度、提高内部骨骼的互连、增加骨质量、治疗软骨和/或骨缺损、提高胎儿出生体重、预防蛀牙、使牙齿表面再矿化、治疗牙本质过敏, 以及施用至骨部位以促进该部位处的新骨生长。

## 3. 1823626 Theobromine having carcinogenesis suppressing function

CN 30.08.2006

A23L 1/30

200610009414.6

LOTTE Confectionery Co., Ltd.

Lee Hyong Joo

Disclosed is theobromine with an anti-carcinogenic activity which inhibits the suppression of GJIC (gap junctional intercellular communication), a pathological phenomenon occurring during development of various kinds of cancers including liver cancer, as well as DNA synthesis of cancer cells thereby inhibiting proliferation of liver, gastric and colon cancer cells.



## 1. (WO2016141458) BISPHENOL ETHER DERIVATIVES AND METHODS FOR USING THE SAME

PCT Biblio. Data Description Claims National Phase Notices **Compounds** Drawings Documents

Latest bibliographic data on file with the International Bureau [Submit observation](#)

PermaLink 

Pub. No.: WO/2016/141458 International Application No.: PCT/CA2016/000070

Publication Date: 15.09.2016 International Filing Date: 11.03.2016

IPC: C07C 69/21 (2006.01), A61K 31/05 (2006.01), A61P 35/00 (2006.01), C07C 43/23 (2006.01), C07F 9/40 (2006.01) 

Applicants: BRITISH COLUMBIA CANCER AGENCY BRANCH [CA/CA]; 600 West 10th Avenue Vancouver, British Columbia V5Z 4E6 (CA).  
THE UNIVERSITY OF BRITISH COLUMBIA [CA/CA]; University-Industry Liaison Office #103-6190 Agronomy Road Vancouver, British Columbia V6T 1ZE (CA)

Inventors: ANDERSEN, Raymond John; (CA).  
JIAN, Kunzhong; (CA).  
SADAR, Marianne Dorothy; (CA).  
MAWJI, Nasrin R.; (CA).  
BANUELOS, Carmen Adriana; (CA)

Agent: DEETH WILLIAMS WALL LLP; 150 York Street, Suite 400 Toronto, Ontario M5H 3S5 (CA)

Priority Data: 62/131,969 12.03.2015 US

Title (EN) BISPHENOL ETHER DERIVATIVES AND METHODS FOR USING THE SAME  
(FR) DÉRIVÉS D'ÉTHÉR DE BISPHÉNOL ET LEURS PROCÉDÉS D'UTILISATION

Abstract: (EN) Compounds having a structure of Formula I, or a pharmaceutically acceptable salt, tautomer or stereoisomer thereof, wherein R<sup>1</sup>, R<sup>2</sup>, L<sup>1</sup>, L<sup>2</sup>, L<sup>3</sup>, X, a, b, c, n, and m are as defined herein, are provided. Uses of such compounds for modulating androgen receptor activity and uses as therapeutics as well as methods for treatment of subjects in need thereof, including prostate cancer are also provided.  
(FR) Cette invention concerne des composés ayant une structure de formule I : ou un sel, un tautomère ou un stéréoisomère pharmaceutiquement acceptable de ceux-ci, où R<sup>1</sup>, R<sup>2</sup>, L<sup>1</sup>, L<sup>2</sup>, L<sup>3</sup>, X, a, b, c, n et m étant tels que définis dans la présente. L'invention concerne également les utilisations de ces composés pour moduler l'activité du récepteur des androgènes et leurs utilisations comme substances thérapeutiques, ainsi que des méthodes destinées à traiter des sujets en ayant besoin, dont des sujets atteints de cancer de la prostate.

Designated States: AE, AG, AL, AM, AO, AT, AU, AZ, BA, BB, BG, BH, BN, BR, BW, BY, BZ, CA, CH, CL, CN, CO, CR, CU, CZ, DE, DK, DM, DO, DZ, EC, EE, EG, ES, FI, GB, GD, GE, GH, GM, GT, HN, HR, HU, ID, IL, IN, IR, IS, JP, KE, KG, KN, KP, KR, KZ, LA, LC, LK, LR, LS, LU, LY, MA, MD, ME, MG, MK, MN, MW, MX, MY, MZ, NA, NG, NI, NO, NZ, OM, PA, PE, PG, PH, PL, PT, QA, RO, RS, RU, RW, SA, SC, SD, SE, SG, SK, SL, SM, ST, SV, SY, TH, TJ, TM, TN, TR, TT, TZ, UA, UG, US, UZ, VC, VN, ZA, ZM, ZW.  
African Regional Intellectual Property Organization (BW, GH, GM, KE, LR, LS, MW, MZ, NA, RW, SD, SL, ST, SZ, TZ, UG, ZM, ZW)  
Eurasian Patent Organization (AM, AZ, BY, KG, KZ, RU, TJ, TM)  
European Patent Office (AL, AT, BE, BG, CH, CY, CZ, DE, DK, EE, ES, FI, FR, GB, GR, HR, HU, IE, IS, IT, LT, LU, LV, MC, MK, MT, NL, NO, PL, PT, RO, RS, SE, SI, SK, SM, TR)

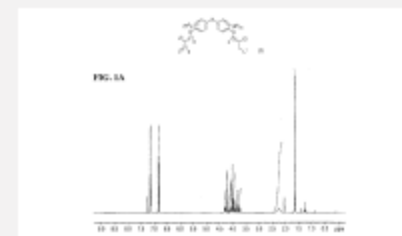

1. (WO2016141458) BISPHENOL ETHER DERIVATIVES AND METHODS FOR USING THE SAME

PCT Biblio. Data Description Claims National Phase Notices Compounds Drawings Documents

Title Abstract Description Claims

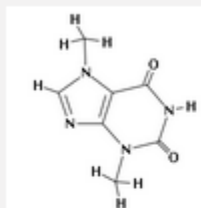

Theobromine

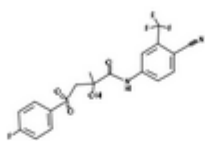
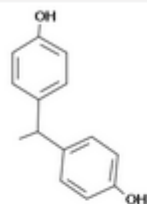

Bicalutamide

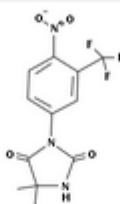

Nilutamide

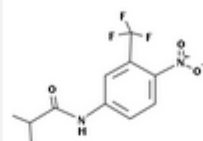

Flutamide

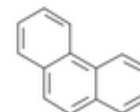
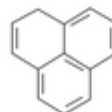
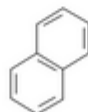
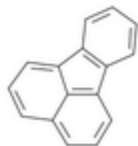
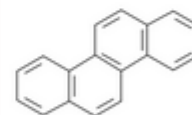
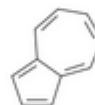
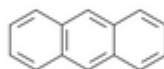
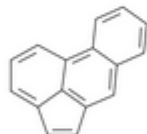
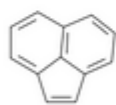
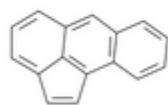
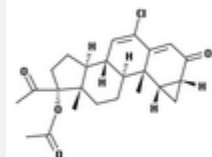
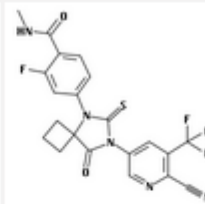



# Add search criteria

- PCT applications
- Chocolate in English abstract

Results 1-10 of 14,423 for Criteria:CHEM:(YAPQBQYLJRXSA-UHFFFAOYSA-N) Office(s):all Language:EN Stemming: true

prev 1 2 3 4 5 6 7 8 9 10 next Page: 1 / 1443 Go >

Refine Search CHEM:(YAPQBQYLJRXSA-UHFFFAOYSA-N) Search RSS

Instant Help

Results 1-10 of 14,423 for Criteria:CHEM:(YAPQBQYLJRXSA-UHFFFAOYSA-N) Office(s):all Language:EN Stemming: true

prev 1 2 3 4 5 6 7 8 9 10 next Page: 1 / 1443 Go >

Refine Search  CHEM:(YAPQBQYLJRXSA-UHFFFAOYSA-N) AND CTR:WO AND EN\_AB:chocolate Search RSS

Instant Help

Results 1-10 of 9 for Criteria:(CTR:WO AND CHEM:(YAPQBQYLJRXSA-UHFFFAOYSA-N)) AND EN\_AB:chocolate Office(s):wo Language:All Stemming: true

prev 1 next Page: 1 / 1 Go >

Refine Search (CTR:WO AND CHEM:(YAPQBQYLJRXSA-UHFFFAOYSA-N)) AND EN\_AB:chocolate

Search

RSS



Analysis

Sort by: Pub Date Asc View All List Length 10 Machine translation

Int.Class	Appl.No	Title	Applicant	Ctr	PubDate
1. WO/2002/074321	COMPOSITION COMPRISING COCOA AND A DOPAMINE D2 RECEPTOR AGONIST			WO	26.09.2002
A23L 1/30	PCT/NL2002/000184	N.V. NUTRICIA		TER LAAK, Wies	
2. WO/2002/078746	NOVEL CHOCOLATE COMPOSITION AS DELIVERY SYSTEM FOR NUTRIENTS AND MEDICATIONS			WO	10.10.2002
A23G 1/00	PCT/US2002/009597	ALTAFER, Paulo		HUGHES, Kerry	

The invention pertains to a composition and a method for the treatment of mood disorders, in particular of treating, preventing or alleviating depression, mood disorders or insufficient mood, obesity, overweight, premenstrual syndrome, craving, carbohydrate craving, chocolate craving, menopausal complaints, erectile dysfunction and/or reduced libido. The composition contains cocoa or one or more of its pharmacologically active components, and a dopamine D2 receptor agonist.

A novel chocolate product for use in delivering medicaments and/or nutrients to animals, particularly humans, specially formulated so that the craving for such product by animals, particularly humans, is significantly greater than the craving for chocolate conventionally used in pharmaceutical compositions and the concentration, optimization, and the addition of endogenous and exogenous ingredients to increase such craving as well as to treat specific indications. The chocolate product contains: from about 0.5 to about 200 milligrams, more preferably from about 5 to about 20 milligrams, of one or more biogenic amines per 1 gram of the chocolate product; from about 10 to about 500 milligrams, more preferably from about 20 to about 200 milligrams, of one or more amino acids per 1 gram of the chocolate product; (C) from about 1 microgram to about 20 milligrams, more preferably from about 10 micrograms to about 10 milligrams, of one or more of: methyl tetrahydroisoquinoline, N-acylethanolamines, and/or anandamide and/or salsolinol per 1 gram of the chocolate product; (D) from about 0.2 to about 30 milligrams of at least one trace mineral per 1 gram of the chocolate product; and (E) from 0.6 to about 500 milligrams, more preferably from about 35 to about 100 milligrams, of one or more methylxanthine alkaloids per 1 gram of the chocolate product. The chocolate product used in this invention also preferably contains effective amounts of at least one chocolate aroma and at least one vanilla aroma.

# Example: Viagra

- Chemical names: Sildenafil; 139755-83-2; Revatio; VIAGRA; Sildenafil [INN:BAN]; ChEMBL192
- Molecular formula:  $\text{C}_{22}\text{H}_{30}\text{N}_6\text{O}_4\text{S}$

# Chemical compound search

Chemical compounds search [Help]

[Convert structure](#) [Structure editor](#) [SubStructure](#) [Upload structure](#)

Compound name

Search for scaffold:  Office:  All

Tooltip Help

## Analysis

Sort by: Relevance

View All

List Length 10

Machine translation

Side-by-side

Int.Class	Appl.No	Applicant	Ctrl	PubDate
<b>1. 106132204</b>	<b>Sildenafil solutions and methods of making and using same</b>		CN	16.11.2016
A01N 43/90	201580013951.5	VIGOROUS SOLUTIONS LTD.		ROGOSNITZKY MOSHE
<p>The invention discloses sildenafil solutions and methods of making and using the same. The invention relates to compositions containing dissolved sildenafil citrate and methods of producing such compositions, wherein sildenafil citrate is dissolved in water mixed with one or more alcohols, and optionally a ketone may be used to enhance solubility. The invention also relates to methods of using such compositions containing dissolved sildenafil citrate utilizing dosages significantly below existing therapeutic dosages of sildenafil citrate.</p>				
<b>2. 105353095</b>	<b>一种西地那非及其结构类似物的免疫检测方法</b>		CN	24.02.2016
C07D 487/04	201510782599.3	华南农业大学		沈玉栋
<p>本发明属于免疫检测技术领域,公开了一种西地那非及其结构类似物的免疫检测方法,即以巯基西地那非半抗原制备人工抗原,再制备得到抗体,并用于检测西地那非及其结构类似物,该方法克服了现有检测西地那非技术的缺陷和步骤,对西地那非的最大检测范围为0.024~1.21 ng/mL,灵敏度为0.17 ng/mL,检出限为0.008 ng/mL,回收率为86.0~90.8%,该方法检测快速、大大缩短了检测时间,不考虑检测人员操作熟练程度的影响,整个检测过程仅仅需要80min左右即可完成,且检出限更低、灵敏度更高。</p>				
<b>3. 105250242</b>	<b>包含西地那非游离碱的膜制剂及其生产方法</b>		CN	20.01.2016
A61K 9/70	201510567618.0	西梯茜生命工学股份有限公司		全泓烈
<p>本发明公开了一种包含西地那非游离碱的膜制剂及其生产方法。具体地,本发明涉及制备膜的方法,所述膜包含均匀分散于其中的高含量的西地那非游离碱,具有适当的尺寸和厚度,并且还因其柔韧性而不易破损,从而提供了良好操作性。本发明还涉及通过所述方法制备的包含西地那非游离碱的膜。</p>				
<b>4. 102174474</b>	<b>Sildenafil monoclonal antibody and colloidal gold chromatography test strip used for detecting sildenafil</b>		CN	07.09.2011
C12N 5/20	201110004723.5	Nantong Egens Biology Technic Co., Ltd.		Ou Weijun
<p>The invention belongs to the field of medicament inspection and discloses a sildenafil monoclonal antibody and a colloidal gold chromatography test strip used for detecting sildenafil. The sildenafil monoclonal antibody is generated by a hybridoma cell line with the collection number of CCTCC No. C2010123. The sildenafil monoclonal antibody has highly uniform physical and chemical properties, single bioactivity and high specificity of combining the antigen sildenafil. It is convenient to</p>				



# Advanced search

Advanced Search 

Search For:  

[Expand with related terms](#) ↓

Language:  Stem:  Office:  All

Instant Help  Tooltip Help

Results 1-10 of 6,143 for Criteria:EN\_ALLTXT:viagra Office(s):all Language:EN Stemming: true

Page: 1 / 615 Go

Refine Search EN\_ALLTXT:viagra

Search

RSS

Analysis

Sort by: Relevance

View All

List Length 10

Machine translation

Side-by-side

Int.Class	Appl.No	Applicant	Ctr	PubDate
1. 20090246298 <b>Viagra</b>			US	01.10.2009
A61K 36/00	12009258	CEOLA P. STEELE		Steele Ceola Pattiee

1. Couch Grass works on the prostate gland to clear it of bacteria. If this bacteria is allowed to build up it could cause arthritis neuralgia, cancer, and neurological, problems. The blood is cleaned by the Magistral **Viagra** and hormones are activated. Couch Grass is in the carrot family, it is potent. The potency of Couch Grass is 10 to 1 it is 10× more potent than carrots. It is very high in potassium.

- 2. Stale Red Clover, quantity of herb to be used is, judged on the weight of 150 pound man. This herb contains ammonia fixing bacteria, it works on the kidneys. The sodium, potassium cells of the kidneys are activated. Salts and potassium cells of the kidneys are activated. Salts and potassium work on the gut to produce a super abundant amount of energy, water is the catalyst for the production of hormones in the blood. These hormones travel through out the body in the blood. They work on the principle of vasodilation and vasoconstriction. I want to focus on the vasoconstriction.
- 3. Skull Cap works on the body using the volatile fixed oils, (essential oil) The main color titrated out is green, green works on the heart. In the Contraction phase the heart rests. There are seven botanical herbs in the Magistral **Viagra**. The synergistic effect causes the free flow of hormones in Endocrine system, (duct-less glands) to operate efficiently. It helps to rid the body of diseased bacteria and gives the patient confidence in coitus.

## 2. 20060069072 Method of male sexual enhancement

A61K 31/56 10952147 WOODWARD JOHN R Woodward John R. US 30.03.2006

A method of sexual enhancement in men includes the steps of testing the blood of the man to determine the levels of free estradiol and free testosterone therein, assuring that the man's blood includes free estradiol within a first predetermined range and free testosterone within a second predetermined range, and thereafter administrating a drug selected from the group consisting of **VIAGRA**® (sildenafil citrate), LEVITRA® (vardenafil hydrochloride), and CIALIS® (tadalafil) prior to sexual activity.

## 3. 2001286995 Method for treating erectile dysfunction and increasing libido in men

AU 22.11.2001

ORGANIZATION

# Example formula searching

- 4-(3-chloro-2-fluoroanilino)-7-methoxy-6-((1-(N-methylcarbamoylmethyl)piperidin-4-yl)oxy)quinazoline



prev

1

2

3

4

next

Page: 1 / 4 [Go >](#)

Refine Search CHEM:(DFJSJLGUFXDJP-UHFFFAOYSA-N)

Search

RSS

Instant Help 

## Analysis

Sort by: Relevance  View All  List Length 10  [Machine translation](#)

Int.Class	Appl.No	Title	Applicant	Ctr	PubDate
1. 20120108814		Process for the preparation of 4-(3-chloro-2-fluoroanilino)-7-methoxy-6-([1-(N-methylcarbamoylmethyl)piperidin-4-yl]oxy)quinazoline		US	03.05.2012
C07D 239/72	13264217		Boardman Kay Alison		Boardman Kay Alison
Processes for the preparation of 4-(3-chloro-2-fluoroanilino)-7-methoxy-6-([1-(N-methylcarbamoylmethyl)piperidin-4-yl]oxy)quinazoline, salts thereof, and the intermediates used in the process are described.					
2. 20090286982		Crystalline 4-(3-chloro-2-fluoroanilino)-7-methoxy-6-([1-(N-methylcarbamoylmethyl)piperidin-4-yl]oxy)quinazoline difumarate form A		US	19.11.2009
A61K 31/517	12463624		AstraZeneca AB		Dobson Andrew Hornby
4-(3-chloro-2-fluoroanilino)-7-methoxy-6-([1-(N-methylcarbamoylmethyl)piperidin-4-yl]oxy)quinazoline difumarate, pharmaceutical compositions containing the difumarate, the use of the difumarate in the treatment of hyperproliferative disorders such as cancer and processes for the manufacture of the difumarate are described.					
3. 20120035363		Crystalline 4-(3-chloro-2-fluoroanilino)-7-methoxy-6-([1-(N-methylcarbamoylmethyl)piperidin-4-yl]oxy)quinazoline difumarate Form A		US	09.02.2012
A61K 31/517	13273392		Dobson Andrew Hornby		Dobson Andrew Hornby
4-(3-chloro-2-fluoroanilino)-7-methoxy-6-([1-(N-methylcarbamoylmethyl)piperidin-4-yl]oxy)quinazoline					
embedded image					
<ul style="list-style-type: none"> <li>o difumarate, pharmaceutical compositions containing the difumarate, the use of the difumarate in the treatment of hyperproliferative disorders such as cancer and processes for the manufacture of the difumarate are described.</li> </ul>					

# Example: Ritonavir

Chemical compounds search [Help]

[Convert structure](#) [Structure editor](#) [SubStructure](#) [Upload structure](#)

Compound name

Search for scaffold:  Office:  All

Tooltip Help

Analysis									
Countries		IPC		Inventor		Applicant		Pub Date	
Name	No	Name	No	Name	No	Name	No	Date	No
United States	9,631	A61K	21,116	Ruben Steven M.	328	Human Genome Sciences, Inc.	366	1994	1
PCT	6,499	A61P	10,358	Rosen Craig A.	309	HUMAN GENOME SCIENCES, INC.	336	1995	6
Japan	3,638	C07D	8,992	RUBEN, Steven, M.	249	BRISTOL-MYERS SQUIBB COMPANY	270	1996	29
China	2,530	C07K	4,253	ROSEN, Craig, A.	248	RUBEN, Steven, M.	249	1997	51
European Patent Office	1,839	C12N	2,982	Ni Jian	157	ROSEN, Craig, A.	248	1998	111
		C12Q	1,775	Shi Yanggu	92	ASTRAZENECA AB	239	1999	145
Republic of Korea	715	G01N	1,627	Ebner Reinhard	88	Gilead Sciences, Inc.	196	2000	392
EAPO	491	C07C	1.391	Moore Paul A.	82	Bristol-Mvers Squibb Company	181	2001	540

# Patent landscape Report on Ritonavir- October 2011

[http://www.wipo.int/edocs/pubdocs/en/patents/946/wipo\\_pub\\_946.pdf](http://www.wipo.int/edocs/pubdocs/en/patents/946/wipo_pub_946.pdf)

- Ritonavir is an antiretroviral drug from the protease inhibitor class used to treat HIV infection and AIDS. Ritonavir is included in the WHO Model List of Essential Medicines (EML)1.
- The originator company is Abbott Laboratories, which markets Ritonavir under the brand name Norvir, or in combination with the protease inhibitor Lopinavir, as Kaletra or Aluvia. The U.S. Food and Drug Administration (FDA) approved the drug in March 1996 for oral solution and in June 1999 for capsules.

# Can I search?

- Stereoisomer
- Monomer
- Enantiomer
- CAS name
- Polymer, Poly(vinyl alcohol)
- Inorganic cluster
- Metal-organic framework
- Transformable into InChI reactions
- CAS number
- DNA sequence listing



# Restrict to the *claims* field

- CHEM:( Inchikey BEFORE10000 description)

# Searches

The screenshot displays the top navigation bar of the WIPO search portal. The navigation menu includes 'Search', 'Browse', 'Translate', and 'News'. On the right side of the navigation bar, there are icons for user profile, settings, and help. A dropdown menu is open over the 'Search' button, listing the following options: 'Simple', 'Advanced Search', 'Field Combination', 'Cross Lingual Expansion' (which is highlighted with a purple background), and 'Chemical compounds (login required)'. Below the navigation bar, a search input field is visible with a question mark icon to its right. To the right of the input field, the text 'Office:All' is displayed, followed by a 'Search' button. A blue banner above the search field contains the text '2 million patent documents including 3.5 million published international patent applications (PCT). Detailed coverage'. At the bottom of the page, the WIPO logo is present, consisting of the text 'WIPO' in a large font, with 'WORLD INTELLECTUAL PROPERTY ORGANIZATION' in a smaller font below it.

Search | Browse | Translate | News

Simple  
Advanced Search  
Field Combination  
Cross Lingual Expansion  
Chemical compounds (login required)

2 million patent documents including 3.5 million published international patent applications (PCT). Detailed coverage

Office:All Search

WIPO  
WORLD  
INTELLECTUAL PROPERTY  
ORGANIZATION

# CLIR

## Cross-Lingual Information Retrieval

# What is it?

- 1. Finds synonyms:

**container** → **receptacles/ reservoir/tank**

- 2. Translates into 13 languages

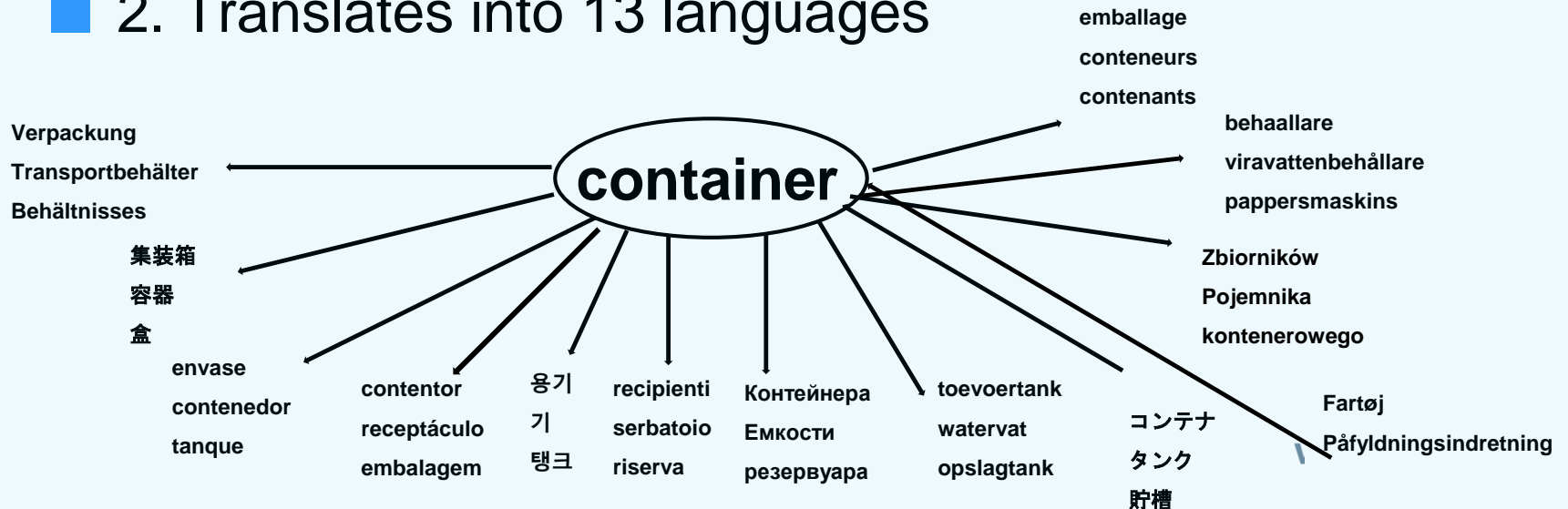

Q:1 How many of you are already familiar with CLIR?

**A** yes

**B** no

# CLIR – 14 languages available

## NON-ASIAN

- Danish
- Dutch
- English
- French
- German
- Italian
- Polish
- Portuguese
- Russian
- Spanish
- Swedish

## ASIAN

- Chinese
- Japanese
- Korean

# Historical background

REVERENDFUN.COM COPYRIGHT G4, INC.

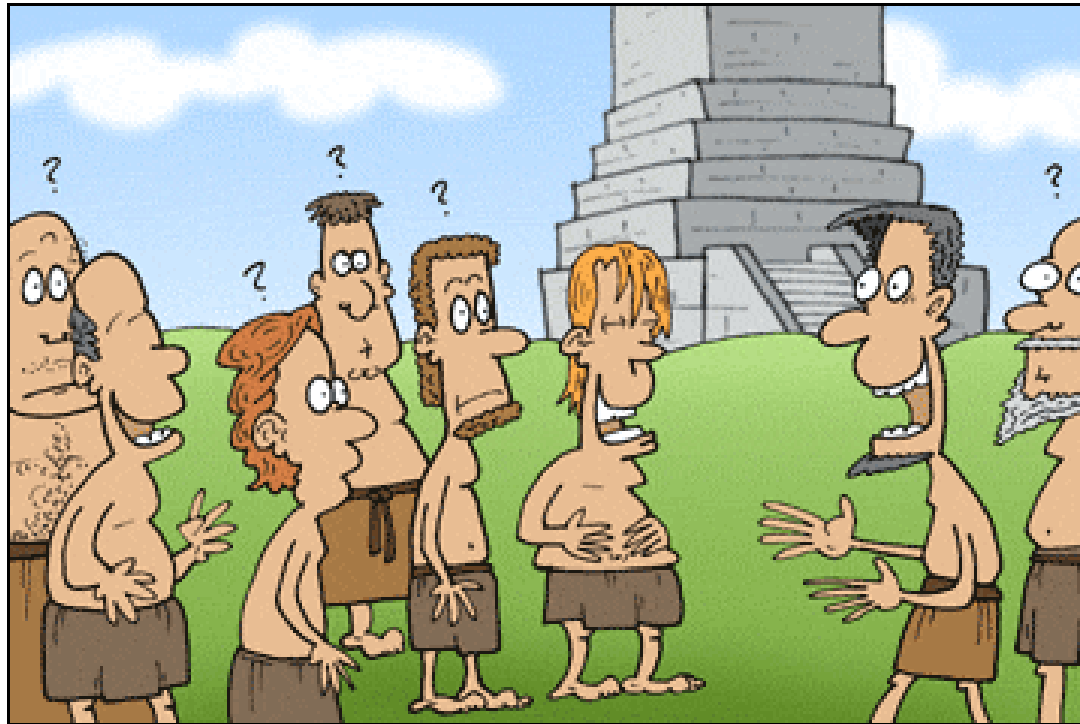

(See Genesis 11:1-9)

11-27-2006

NATURALLY, ONLY A PERCENTAGE OF THE  
POST-BABEL CROWD GOT HIS JOKE ABOUT  
"BABELLING ON"

# How to use it? Interface

Cross Lingual Expansion [\[Help\]](#)

Search For: \*

Query Language:

Expansion Mode:

Precision  Recall





# Query language

- Define the language of the query:



# Languages

- Chinese
- Danish
- Dutch
- English
- French
- German
- Italian
- Japanese
- Korean
- Polish
- Portuguese
- Russian
- Spanish
- Swedish

# Expansion mode

- 2 modes:
  - Automatic = 1 step
  - Supervised = 4 steps

# CLIR: precision vs recall



**Precision = Exactness or fidelity**  
Everything returned is relevant



Not all relevant items might have been found



**Recall = Completeness**  
All is included, nothing is missed



A lot of useless results could be returned  
Sorting is necessary

# Example: precision

Cross Lingual Expansion [Help]

Search For: \*

Query Language:

Expansion Mode:

Precision  Recall

# Results for «precision»

Results 1-10 of **16,723,553** for Criteria:FP:((EN\_TI:("device") OR EN\_AB:("device")) OR (DA\_TI:("apparat") OR DA\_AB:("apparat")) OR (DE\_TI:("Vorrichtung") OR DE\_AB:("Vorrichtung")) OR (ES\_TI:("dispositivo") OR ES\_AB:("dispositivo")) OR (FR\_TI:("dispositif") OR FR\_AB:("dispositif")) OR (IT\_TI:("dispositivo") OR IT\_AB:("dispositivo")) OR (JA\_TI:("装置") OR JA\_AB:("装置")) OR (KO\_TI:("장치") OR KO\_AB:("장치")) OR (NL\_TI:("inrichting") OR NL\_AB:("inrichting")) OR (PL\_TI:("urządzenie") OR PL\_AB:("urządzenie")) OR (PT\_TI:("dispositivo") OR PT\_AB:("dispositivo")) OR (RU\_TI:("устройство") OR RU\_AB:("устройство")) OR (SV\_TI:("anordning") OR SV\_AB:("anordning")) OR (ZH\_TI:("部件") OR ZH\_AB:("部件")))) Office(s):all Language:EN Stemming: true

1 2 3 4 5 6 7 8 9 10 Page: 1 / 1672356 Go

# Example: recall

Cross Lingual Expansion [\[Help\]](#)

Search For: \*

Query Language:

Expansion Mode:

Precision  Recall

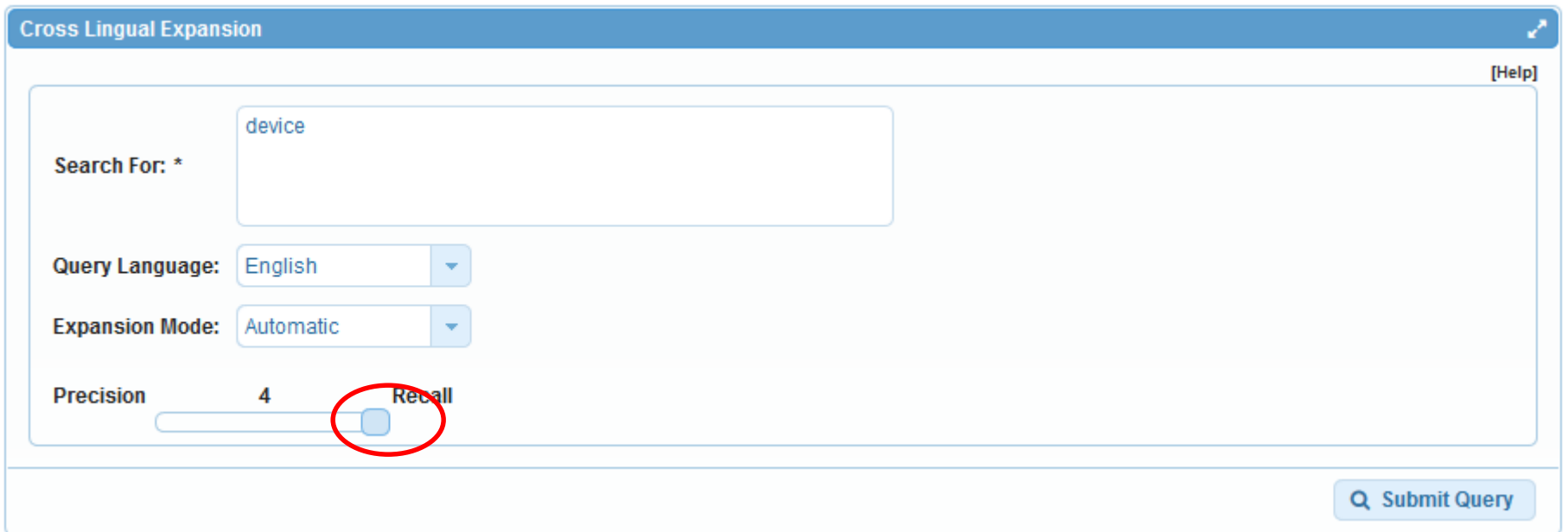
The image shows a web interface for 'Cross Lingual Expansion'. At the top, there is a blue header bar with the text 'Cross Lingual Expansion' and a small icon on the right. Below the header, there is a white search area with a text input field containing the word 'device'. To the left of the input field is the label 'Search For: \*'. Below the input field, there are two dropdown menus: 'Query Language:' set to 'English' and 'Expansion Mode:' set to 'Automatic'. At the bottom of the search area, there is a slider control labeled 'Precision' on the left and 'Recall' on the right. The slider is currently positioned at the value '4'. A red circle is drawn around the slider's handle, which is positioned closer to the 'Recall' end. In the bottom right corner of the interface, there is a button with a magnifying glass icon and the text 'Submit Query'.

# Results for «recall»

Results 1-10 of 37,588,102 for Criteria:FP:(EN\_TI:(("device" OR "apparatus")) OR EN\_AB:(("device" OR "apparatus")) OR (DA\_TI:(("apparat" OR "anordning" OR "indretning" OR "arrangement" OR "anlæg" OR "enhed" OR "kobling" OR "apparatur" OR "udstyr") OR DA\_AB:(("apparat" OR "anordning" OR "indretning" OR "arrangement" OR "anlæg" OR "enhed" OR "kobling" OR "apparatur" OR "udstyr"))) OR (DE\_TI:(("Vorrichtung" OR "Gerät" OR "Einrichtung" OR "Anordnung") OR DE\_AB:(("Vorrichtung" OR "Gerät" OR "Einrichtung" OR "Anordnung"))) OR (ES\_TI:(("dispositivo" OR "aparato" OR "instalación") OR ES\_AB:(("dispositivo" OR "aparato" OR "instalación"))) OR (FR\_TI:(("dispositif" OR "appareil") OR FR\_AB:(("dispositif" OR "appareil"))) OR (IT\_TI:(("dispositivo" OR "apparecchio" OR "apparecchiatura" OR "apparato" OR "impianto" OR "disposizione" OR "attrezzatura") OR IT\_AB:(("dispositivo" OR "apparecchio" OR "apparecchiatura" OR "apparato" OR "impianto" OR "disposizione" OR "attrezzatura"))) OR (JA\_TI:(("装置" OR "端末" OR "それ" OR "方式" OR "ユニット" OR "器具" OR "を" OR "デバイス" OR "設備") OR JA\_AB:(("装置" OR "端末" OR "それ" OR "方式" OR "ユニット" OR "器具" OR "を" OR "デバイス" OR "設備"))) OR (KO\_TI:(("장치" OR "소자" OR "디바이스") OR KO\_AB:(("장치" OR "소자" OR "디바이스"))) OR (NL\_TI:(("inrichting" OR "apparaat" OR "toestel" OR "werkwijze" OR "het" OR "apparatuur") OR NL\_AB:(("inrichting" OR "apparaat" OR "toestel" OR "werkwijze" OR "het" OR "apparatuur"))) OR (PL\_TI:(("urządzenie" OR "aparatura" OR "układ" OR "aparat") OR PL\_AB:(("urządzenie" OR "aparatura" OR "układ" OR "aparat"))) OR (PT\_TI:(("dispositivo" OR "aparelho" OR "de" OR "equipamento" OR "aparelhagem" OR "aparato" OR "instalação" OR "sistema") OR PT\_AB:(("dispositivo" OR "aparelho" OR "de" OR "equipamento" OR "aparelhagem" OR "aparato" OR "instalação" OR "sistema"))) OR (RU\_TI:(("устройство" OR "установка" OR "аппарат") OR RU\_AB:(("устройство" OR "установка" OR "аппарат"))) OR (SV\_TI:(("anordning" OR "apparat" OR "apparatur" OR "system" OR "anläggning") OR SV\_AB:(("anordning" OR "apparat" OR "apparatur" OR "system" OR "anläggning"))) OR (ZH\_TI:(("部件" OR "装置" OR "器具" OR "化合物" OR "及" OR "和" OR "器械" OR "剂" OR "设备") OR ZH\_AB:(("部件" OR "装置" OR "器具" OR "化合物" OR "及" OR "和" OR "器械" OR "剂" OR "设备")))) Office(s):all Language:EN Stemming: true

1 2 3 4 5 6 7 8 9 10 Page: 1 / 3758811 Go

Refine Search

FP:(EN\_TI:(("device" OR "apparatus")) OR EN\_AB:(("device" OR "apparatus")) OR (DA\_TI:(("apparat" OR "anordning" OR "indretning" OR "arrangement" OR "anlæg" OR "enhed" OR "kobling" OR "apparatur" OR "udstyr") OR DA\_AB:(("apparat" OR "anordning" OR "indretning" OR "arrangement" OR "anlæg" OR "enhed" OR "kobling" OR "apparatur" OR "udstyr"))) OR (DE\_TI:(("Vorrichtung" OR "Gerät" OR "Einrichtung" OR "Anordnung") OR DE\_AB:(("Vorrichtung" OR "Gerät" OR "Einrichtung" OR "Anordnung"))) OR (ES\_TI:(("dispositivo" OR "aparato" OR "instalación") OR ES\_AB:(("dispositivo" OR "aparato" OR "instalación"))) OR (FR\_TI:(("dispositif" OR "appareil") OR FR\_AB:(("dispositif" OR "appareil"))) OR (IT\_TI:(("dispositivo" OR "apparecchio" OR "apparecchiatura" OR "apparato" OR "impianto" OR "disposizione" OR "attrezzatura") OR IT\_AB:(("dispositivo" OR "apparecchio" OR "apparecchiatura" OR "apparato" OR "impianto" OR "disposizione" OR "attrezzatura"))) OR (JA\_TI:(("装置" OR "端末" OR "それ" OR "方式" OR "ユニット" OR "器具" OR "を" OR "デバイス" OR "設備") OR JA\_AB:(("装置" OR "端末" OR "それ" OR "方式" OR "ユニット" OR "器具" OR "を" OR "デバイス" OR "設備"))) OR (KO\_TI:(("장치" OR "소자" OR "디바이스") OR KO\_AB:(("장치" OR "소자" OR "디바이스"))) OR (NL\_TI:(("inrichting" OR "apparaat" OR "toestel" OR "werkwijze" OR "het" OR "apparatuur") OR NL\_AB:(("inrichting" OR "apparaat" OR "toestel" OR "werkwijze" OR "het" OR "apparatuur"))) OR (PL\_TI:(("urządzenie" OR "aparatura" OR "układ" OR "aparat") OR PL\_AB:(("urządzenie" OR "aparatura" OR "układ" OR "aparat"))) OR (PT\_TI:(("dispositivo" OR "aparelho" OR "de" OR "equipamento" OR "aparelhagem" OR "aparato" OR "instalação" OR "sistema") OR PT\_AB:(("dispositivo" OR "aparelho" OR "de" OR "equipamento" OR "aparelhagem" OR "aparato" OR "instalação" OR "sistema"))) OR (RU\_TI:(("устройство" OR "установка" OR "аппарат") OR RU\_AB:(("устройство" OR "установка" OR "аппарат"))) OR (SV\_TI:(("anordning" OR "apparat" OR "apparatur" OR "system" OR "anläggning") OR SV\_AB:(("anordning" OR "apparat" OR "apparatur" OR "system" OR "anläggning"))) OR (ZH\_TI:(("部件" OR "装置" OR "器具" OR "化合物" OR "及" OR "和" OR "器械" OR "剂" OR "设备") OR ZH\_AB:(("部件" OR "装置" OR "器具" OR "化合物" OR "及" OR "和" OR "器械" OR "剂" OR "设备")))) Office(s):all Language:EN Stemming: true

Search

RSS



# Example

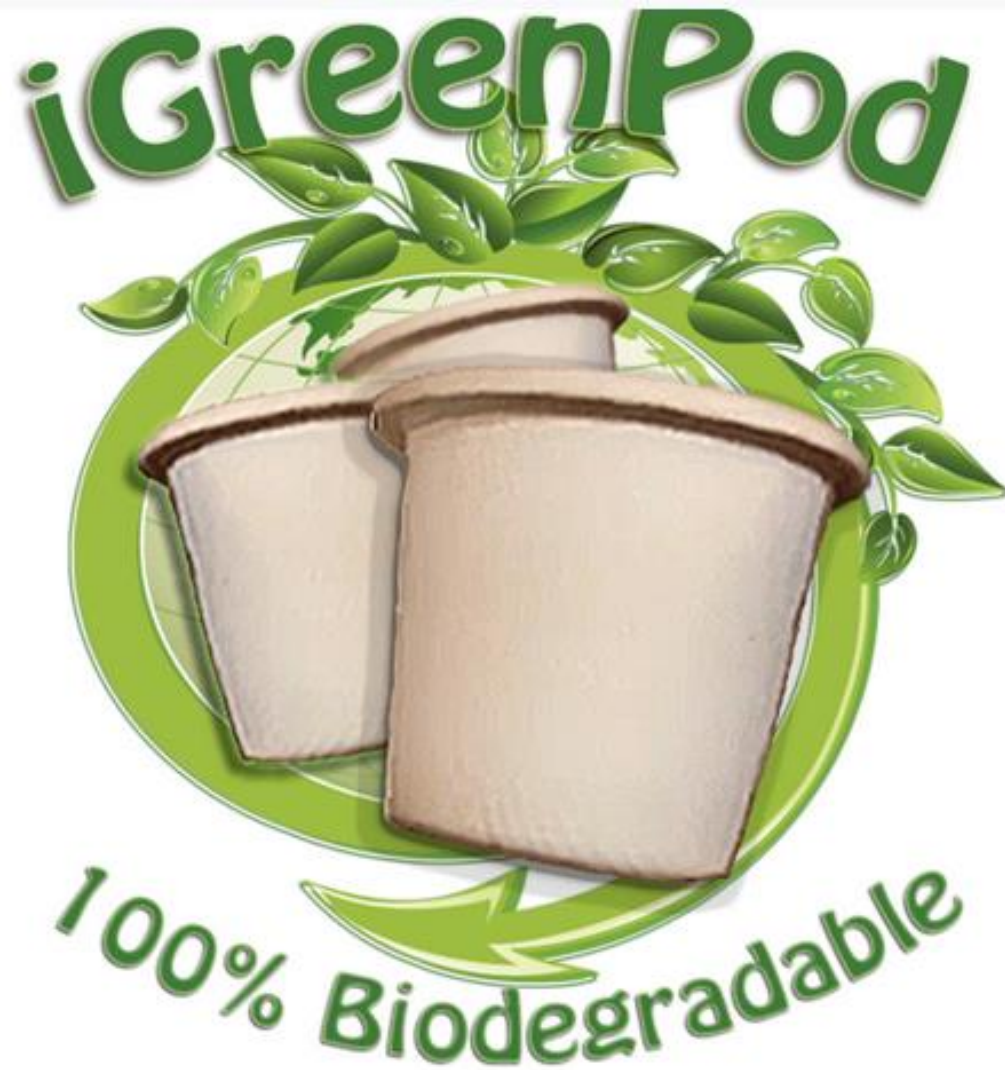

■ Source: <https://www.kickstarter.com/projects/igreenpod/biodegradable-coffee-pod-from-portland-oregon>

# Automatic mode

Cross Lingual Expansion [Help]

Search For: \*

Query Language:





Expansion Mode:

Precision  Recall

Results 1-10 of 13 for Criteria:FP:(EN\_Tl:("biodegradable coffee capsule"~21) OR EN\_AB:("biodegradable coffee capsule"~21)) OR (DA\_Tl:("bionedbrydelige kaffe kapsel"~22 OR "biologisk nedbrydelige kaffe kapsel"~22 OR "bionedbrydelige kaffe hætte"~22 OR "biologisk nedbrydelige kaffe hætte"~22 OR "nedbrydeligt materiale kaffe kapsel"~22 OR "nedbrydeligt materiale kaffe hætte"~22) OR DA\_AB:("bionedbrydelige kaffe kapsel"~22 OR "biologisk nedbrydelige kaffe kapsel"~22 OR "bionedbrydelige kaffe hætte"~22 OR "biologisk nedbrydelige kaffe hætte"~22 OR "nedbrydeligt materiale kaffe kapsel"~22 OR "nedbrydeligt materiale kaffe hætte"~22)) OR (DE\_Tl:("biologisch Kaffeekapsel"~22 OR "bioabbaubaren Kaffeekapsel"~22 OR "biologisch Kaffe Kapsel"~22 OR "Biologisch abbaubare Kaffeekapsel"~22 OR "biodegradierbarer Kaffeekapsel"~22 OR "bioabbaubaren Kaffe Kapsel"~22 OR "Biologisch abbaubare Kaffe Kapsel"~22 OR "biodegradierbarer Kaffe Kapsel"~22) OR DE\_AB:("biologisch Kaffeekapsel"~22 OR "bioabbaubaren Kaffeekapsel"~22 OR "biologisch Kaffe Kapsel"~22 OR "Biologisch abbaubare Kaffeekapsel"~22 OR "biodegradierbarer Kaffeekapsel"~22 OR "bioabbaubaren Kaffe Kapsel"~22 OR "Biologisch abbaubare Kaffe Kapsel"~22 OR "biodegradierbarer Kaffe Kapsel"~22)) OR (ES\_Tl:("cápsula de café biodegradable"~22) OR ES\_AB:("cápsula de café biodegradable"~22)) OR (FR\_Tl:("capsule de café biodégradable"~22 OR "capsule à café biodégradable"~22) OR FR\_AB:("capsule de café biodégradable"~22 OR "capsule à café biodégradable"~22)) OR (IT\_Tl:("biodegradabili capsula di caffè"~22) OR IT\_AB:("biodegradabili capsula di caffè"~22)) OR (JA\_Tl:("生分解 コーヒ カプセル"~22 OR "分解性 コーヒ カプセル"~22 OR "生分解 コヒ カプセル"~22 OR "生分解 珈琲 カプセル"~22 OR "生分解 の可 カプセル"~22 OR "分解性 コヒ カプセル"~22 OR "分解性 珈琲 カプセル"~22 OR "分解性 の可 カプセル"~22 OR "生分解 コーヒーカプセル"~22) OR JA\_AB:("生分解 コーヒ カプセル"~22 OR "分解性 コーヒ カプセル"~22 OR "生分解 コヒ カプセル"~22 OR "生分解 珈琲 カプセル"~22 OR "生分解 の可 カプセル"~22 OR "分解性 コヒ カプセル"~22 OR "分解性 珈琲 カプセル"~22 OR "分解性 の可 カプセル"~22 OR "生分解 コーヒーカプセル"~22)) OR (KO\_Tl:("캡슐 커피 생분해성"~22 OR "수소충전장치 커피 생분해성"~22 OR "캡슐을 이용한 커피 생분해성"~22 OR "캡슐 커피믹스 생분해성"~22 OR "수소충전장치 커피믹스 생분해성"~22 OR "캡슐을 이용한 커피믹스 생분해성"~22) OR KO\_AB:("캡슐 커피 생분해성"~22 OR "수소충전장치 커피 생분해성"~22 OR "캡슐을 이용한 커피 생분해성"~22 OR "캡슐 커피믹스 생분해성"~22 OR "수소충전장치 커피믹스 생분해성"~22 OR "캡슐을 이용한 커피믹스 생분해성"~22)) OR (NL\_Tl:("biologisch afbreekbaar koffie patroon"~22 OR "biologisch afbreekbaar koffie capsule"~22 OR "biodegradeerbare koffie patroon"~22 OR "biodegradeerbare koffie capsule"~22 OR "biologisch afbreekbaar koffie omhulsel"~22 OR "biodegradeerbare koffie omhulsel"~22) OR NL\_AB:("biologisch afbreekbaar koffie patroon"~22 OR "biologisch afbreekbaar koffie capsule"~22 OR "biodegradeerbare koffie patroon"~22 OR "biodegradeerbare koffie capsule"~22 OR "biologisch afbreekbaar koffie omhulsel"~22 OR "biodegradeerbare koffie omhulsel"~22)) OR (PL\_Tl:("biodegradowalny kawy kapsułki"~22 OR "biologicznemu kawy kapsułki"~22 OR "rozkładowi kawy kapsułki"~22 OR "podobny kawy kapsułki"~22 OR "biodegradowalna kawy kapsułki"~22 OR "biodegradowalny kawy kapsuła"~22 OR "biodegradowalny kawy dostosowana"~22 OR "biologicznemu kawy kapsuła"~22 OR "rozkładowi kawy kapsuła"~22) OR PL\_AB:("biodegradowalny kawy kapsułki"~22 OR "biologicznemu kawy kapsułki"~22 OR "rozkładowi kawy kapsułki"~22 OR "podobny kawy kapsułki"~22 OR "biodegradowalna kawy kapsułki"~22 OR "biodegradowalny kawy kapsuła"~22 OR "biodegradowalny kawy dostosowana"~22 OR "biologicznemu kawy kapsuła"~22) OR PT\_Tl:("cápsula de café biodegradável"~22 OR "cápsula de café biodegradáveis"~22) OR PT\_AB:("cápsula de café biodegradável"~22 OR "cápsula de café biodegradáveis"~22)) OR (RU\_Tl:("биоразрушаемых кофейная капсула"~22 OR "биоразлагаемый кофейная капсула"~22 OR "биodeградируемого кофейная капсула"~22 OR "биологически разлагаемые кофейная капсула"~22 OR "биоразложимый кофейная капсула"~22 OR "биологически разрушаемая кофейная капсула"~22) OR RU\_AB:("биоразрушаемых кофейная капсула"~22 OR "биоразлагаемый кофейная капсула"~22 OR "биodeградируемого кофейная капсула"~22 OR "биологически разлагаемые кофейная капсула"~22 OR "биоразложимый кофейная капсула"~22 OR "биологически разрушаемая кофейная капсула"~22)) OR (SV\_Tl:("nedbrytbara kaffe patron"~22 OR "nedbrytbara kaffe kapseltyp"~22 OR "nedbrytbara kaffe kapsel"~22 OR "biodegraderbara kaffe patron"~22 OR "biodegraderbara kaffe kapseltyp"~22 OR "biodegraderbara kaffe kapsel"~22 OR "biologiskt nedbrytbart kaffe patron"~22 OR "biologiskt nedbrytbart kaffe kapseltyp"~22 OR "biologiskt nedbrytbart kaffe kapsel"~22) OR SV\_AB:("nedbrytbara kaffe patron"~22 OR "nedbrytbara kaffe kapseltyp"~22 OR "nedbrytbara kaffe kapsel"~22 OR "biodegraderbara kaffe patron"~22 OR "biodegraderbara kaffe kapseltyp"~22 OR "biodegraderbara kaffe kapsel"~22 OR "biologiskt nedbrytbart kaffe patron"~22 OR "biologiskt nedbrytbart kaffe kapseltyp"~22 OR "biologiskt nedbrytbart kaffe kapsel"~22)) OR (ZH\_Tl:("可生物 咖啡胶囊"~22 OR "生物分解型 咖啡胶囊"~22 OR "降解 咖啡胶囊"~22 OR "生物分解性 咖啡胶囊"~22 OR "生物可分解 咖啡胶囊"~22) OR ZH\_AB:("可生物 咖啡胶囊"~22 OR "生物分解型 咖啡胶囊"~22 OR "降解 咖啡胶囊"~22 OR "生物分解性 咖啡胶囊"~22 OR "生物可分解 咖啡胶囊"~22))) Office(s):all Language:EN Stemming: true

Sort by:  View  List Length

Machine translation

-  Wipo Translate
-  Google Translate
-  Bing/Microsoft Translate
-  Baidu Translate

Int.Class	Appl.No	Title
1.	1020110098224	ENVIRONMENT-FRIENDLY AND BIODEGRADABLE RESIN COMPOSITION FOR PREPARING PLASTIC ARTICLES
C08L 101/16	1020100017726	DONGGUK UNIVERSITY COOPERATION FOUNDATION
<p>PURPOSE: An environment-friendly and biodegradable resin composition is provided to improve the effects due to porous bean coffee powder and to enable disposal use. CONSTITUTION: The resin composition comprises a biodegradable polymer resin, bean coffee powder, and starch. The amount of the bean coffee powder is 40-100 parts by weight based on 100 parts by weight of starch. A method for preparing the plastic molded product comprises the steps of: mixing starch and bean coffee powder and drying the mixture to prepare the dried material; pulverizing the dried material to obtain particles with the diameter of 2-5 mm; mixing the particles and the biodegradable polymer resin; and compression-molding the mixture. COPYRIGHT KIPO 2012</p>		

2.	103783049	Sterilization composition containing prothioconazole and abamectin	CN	14.05.2014
A01N 43/90	201410026786.4	ZHEJIANG TIDE CROP TECHNOLOGY CO., LTD.	YANG ZHENGYU	

The invention discloses a sterilization composition containing prothioconazole and abamectin. The sterilization composition contains effective active components, namely, prothioconazole and abamectin with a weight ratio of 60:1-1:60. The sterilization composition at least contains a surfactant so that the active components are favorably dispersed in water when being applied. The sterilization composition disclosed by the invention integrates protection, therapy and deactivating, and can be used in multiple crops such as cereal crops, legume crops, oilseed rape, peanuts, coffee and fruit trees, and used for controlling powdery mildew, rust disease, white rot, brown leaf rust, stripe rust, glume blight, leaf mold, banded sclerotial blight, blight, leaf spot disease, stalk break, net blotch, gray mold, and the like.

3.	104397297	一种松仁咖啡伴侣制品	CN	11.03.2015
A23F 5/40	201410656739.8	哈尔滨工业大学	王振宇	

一种松仁咖啡伴侣制品，属于饮品加工生物技术领域，涉及一种松仁油微胶囊配合咖啡饮品使用的咖啡伴侣制品。所述松仁咖啡伴侣制品由60~80wt.%松仁油微胶囊粉末、20~40wt.%蔗糖制成。本发明所述咖啡伴侣的成分松仁油微胶囊粉末，不饱和脂肪酸含量丰富，尤其是亚油酸含量最高。不饱和脂肪酸能够促进胆固醇代谢，降低血脂，提高血清高密度脂蛋白含量，防止脂质在肝脏和动脉壁沉积，降低血小板凝聚力，减少血栓形成，是高血脂人群保护血管的理想食物。

4.	1020140026074	MANUFACTURING ECO-FRIENDLY PRODUCTS USING COFFEE GROUNDS AND VARIOUS ADHESIVES	kr	05.03.2014
C08J 5/00	1020120093026	GONG, HYUN JUN	GONG, HYUN JUN	

The present invention relates to a method for manufacturing products using coffee grounds, the method of which was invented with the perception that, given the conventional Lego or toys are made of plastic and include harmful chemical substances, an eco-friendly Lego block that has a scent of coffee and reduces environmental pollution could be made by creating Lego blocks from drying the grounds of a coffee bean after extracting the coffee from natural ingredients and mixing adhesives such as glue or starch that are natural adhesive components. The product made in such a manner, by not including toxic chemicals as the products are natural substances, can be very effective for children with

# Supervised mode

Cross Lingual Expansion [\[Help\]](#)

Search For: \*

Query Language:

Expansion Mode:

Precision  Recall

[Next](#)

# Step 1: technical field selection

Cross Lingual Expansion - biodegradable coffee capsule [Help]

- [ADMN] Admin, Business, Management & Soc Sci
- [AERO] Aeronautics & Aerospace Engineering
- [AGRI] Agriculture, Fisheries & Forestry
- [AUDV] Audio, Audiovisual, Image & Video Tech
- [AUTO] Automotive & Road Vehicle Engineering
- [BLDG] Civil Engineering & Building Construction
- [CHEM] Chemical & Materials Technology
- [DATA] Computer Sci, Telecom & Broadcasting
- [ELEC] Electrical Engineering & Electronics
- [ENGY] Energy, Fuels & Heat Transfer Eng
- [ENVR] Environmental & Safety Engineering
- [GENR] Generalities, Language, Media & Info Sci
- [HORO] Precision Mechanics, Jewelry & Horology
- [MARI] Marine Engineering
- [MEAS] Standards, Units, Metrology & Testing

- [HOME] Home Contents & Household Maintenance
- [MANU] Manufacturing & Materials Handling Tech
- [PACK] Packaging & Distribution of Goods
- [FOOD] Foods & Food Technology

→ Add

← Remove

← Back Expand Synonyms

# Step 2: synonym selection

Cross Lingual Expansion - biodegradable coffee capsule [Help]

▼ Term 1: biodegradable

Variants Domains [HOME,MANU,PACK,FOOD]

Keep term untranslated when expanding query in other languages

Less  More

biodegradation  biodegration  bioremediation

Add Variant

▶ Term 2: capsule

▶ Term 3: coffee capsule

▶ Term 4: coffee

← Back Start Over Translate Selected Terms

# Step 3: translated term selection

Cross Lingual Expansion - biodegradable coffee capsule [Help]

English ✕ Danish ✕ German ✕ Spanish ✕ French ✕ Italian ✕ Japanese ✕ Korean ✕ Dutch ✕ Polish ✕ Portuguese ✕ Russian ✕

Swedish ✕ Chinese ✕ IPC ✕

"biodegradable coffee capsule"~21 OR "biodegradable coffee cartridge"~21 OR "biodegradation coffee capsule"~21 OR "biodegradation coffee cartridge"~21

Field(s) you want to search: Abstract

Acceptable distance between matched words: Sentence

Stemming

[← Back](#) [Start Over](#) [Q Submit Query](#)



# Relevance checking

Translate



English Spanish French Korean - detected



English Spanish Arabic

Translate

"캡슐 커피 생분해성"~22 OR "카트리지 커피 생분해성"~22 OR "포드 커피 생분해성"~22



"Biodegradable coffee capsules" ~ 22 OR "cartridge coffee biodegradable" ~ 22 OR "biodegradable coffee pods" to 22



Wrong?

# Fields

Cross Lingual Expansion - biodegradable coffee capsule [Help]

English x Danish x German x Spanish x French x Italian x Japanese x Korean x Dutch x Polish x Portuguese x Russian x  
Swedish x Chinese x IPC x

"biodegradable coffee capsule"~21 OR "biodegradable coffee cartridge"~21 OR "biodegradation coffee capsule"~21 OR "biodegradation coffee cartridge"~21

Field(s) you want to search: Abstract

Acceptable distance between matched words:

Stemming

← Back

Start Over Submit Query

- Title
- Abstract
- Title and Abstract
- Description
- Claims
- Title, Abstract and Claims
- All Text

# Acceptable distance

Cross Lingual Expansion - biodegradable coffee capsule ↗

[Help]

English × Danish × German × Spanish × French × Italian × Japanese × Korean × Dutch × Polish × Portuguese × Russian ×  
Swedish × Chinese × IPC ×

"biodegradable coffee capsule"~21 OR "biodegradable coffee cartridge"~21 OR "biodegradation coffee capsule"~21 OR "biodegradation coffee cartridge"~21

Field(s) you want to search: Abstract

Acceptable distance between matched words: Sentence

Stemming

- Minimal
- Sentence**
- Paragraph
- Page
- Unconstrained

← Back Start Over Q Submit Query

# Stemming

Cross Lingual Expansion - biodegradable coffee capsule [Help]

English × Danish × German × Spanish × French × Italian × Japanese × Korean × Dutch × Polish × Portuguese × Russian ×  
Swedish × Chinese × IPC ×

"biodegradable coffee capsule"~21 OR "biodegradable coffee cartridge"~21 OR "biodegradation coffee capsule"~21 OR "biodegradation coffee cartridge"~21

Field(s) you want to search: Abstract

Acceptable distance between matched words: Sentence

**Stemming**

[← Back](#) [Start Over](#) [Submit Query](#)

# Stemming

- Use of the root form of a word

- displayed

- Display      displaying

- displays

# IPC checking

Cross Lingual Expansion - biodegradable coffee capsule [\[Help\]](#)

English × Danish × German × Spanish × French × Italian × Japanese × Korean × Dutch × Polish × Portuguese × Russian ×  
Swedish × Chinese × **IPC ×**

"biodegradable coffee capsule"~21 OR "biodegradable coffee cartridge"~21 OR "biodegradation coffee capsule"~21 OR "biodegradation coffee cartridge"~21

Field(s) you want to search: Abstract

Acceptable distance between matched words: Sentence

Stemming

[← Back](#) [Start Over](#) [Q Submit Query](#)

Results 1-10 of 18 for Criteria:FP:(EN\_AB:(("biodegradable coffee capsule"~21 OR "biodegradable coffee cartridge"~21 OR "biodegradation coffee capsule"~21 OR "biodegradation coffee cartridge"~21) OR DA\_AB:(("bionedbrydelige kaffe kapsel"~22 OR "biologisk nedbrydelige kaffe kapsel"~22 OR "bionedbrydelige kaffe patron"~22 OR "biologisk nedbrydelige kaffe patron"~22 OR "bionedbrydelige kaffe indsats"~22 OR "biologisk nedbrydelige kaffe indsats"~22 OR "bionedbrydelige kaffe kassette"~22 OR "biologisk nedbrydelige kaffe kassette"~22 OR "bionedbrydelige kaffe holder"~22 OR "biologisk nedbrydelige kaffe holder"~22 OR "bionedbrydelige kaffe paton"~22 OR "biologisk nedbrydelige kaffe paton"~22 OR "biologisk nedbrydning kaffe kapsel"~22 OR "bionedbrydelige kaffe kapsler"~22) OR DE\_AB:(("biologisch Kaffeekapsel"~22 OR "bioabbaubaren Kaffeekapsel"~22 OR "biologisch Kaffeekapsel"~22 OR "abbaubarem Kaffeekapsel"~22 OR "biologischen Abbau Kaffeekapsel"~22 OR "Bioabbau Kaffeekapsel"~22 OR "Abbau Kaffeekapsel"~22 OR "bioabbaubaren Kaffee Kapsel"~22 OR "Biodegradation Kaffeekapsel"~22 OR "abbaubarem Kaffee Kapsel"~22 OR "Biodegradierung Kaffeekapsel"~22 OR "biologischen Abbau Kaffeekapsel"~22 OR "biologischen Abbau Kaffeekapsel"~22 OR "Bioabbau Kaffeekapsel"~22) OR ES\_AB:(("cápsula de café biodegradable"~22) OR FR\_AB:(("capsule de café biodégradable"~22 OR "capsule à café biodégradable"~22 OR "capsule de café biodradation"~22 OR "capsule à café biodradation"~22) OR IT\_AB:(("biodegradabili capsula di caffè"~22) OR JA\_AB:(("生物分解 コーヒー カートリッジ"~22 OR "生分解 コーヒー カートリッジ"~22 OR "分解性 コーヒー カートリッジ"~22 OR "生物分解 コーヒー カプセル"~22 OR "生分解 コーヒー カプセル"~22 OR "分解性 コーヒー カプセル"~22 OR "を分解 コーヒー カートリッジ"~22 OR "バチラス コーヒー カートリッジ"~22 OR "微生物分解 コーヒー カートリッジ"~22 OR "生物崩壊性 コーヒー カートリッジ"~22 OR "を分解 コーヒー カプセル"~22 OR "バチラス コーヒー カプセル"~22 OR "微生物分解 コーヒー カプセル"~22 OR "生物崩壊性 コーヒー カプセル"~22) OR KO\_AB:(("카트리지 커피 생분해성"~22 OR "캡슐 커피 생분해성"~22 OR "수소충전장치 커피 생분해성"~22 OR "우림 용기 커피 생분해성"~22 OR "캡슐을 이용한 커피 생분해성"~22 OR "카트리지 커피믹스 생분해성"~22 OR "캡슐 커피믹스 생분해성"~22 OR "수소충전장치 커피믹스 생분해성"~22 OR "카트리지 커피 생분해"~22 OR "캡슐 커피 생분해"~22 OR "우림 용기 커피믹스 생분해성"~22 OR "수소충전장치 커피 생분해"~22 OR "캡슐을 이용한 커피믹스 생분해성"~22 OR "우림 용기 커피 생분해"~22) OR NL\_AB:(("biologisch afbreekbaar koffie patroon"~22 OR "biologisch afbreekbaar koffie capsule"~22 OR "biologisch koffie patroon"~22 OR "biologisch koffie capsule"~22 OR "biologisch afbreekbaar koffie cassette"~22 OR "biologisch koffie cassette"~22 OR "biodegradeerbare koffie patroon"~22 OR "biodegradeerbare koffie capsule"~22 OR "biodegradeerbare koffie cassette"~22 OR "biologisch afbreekbaar koffie omhulsel"~22 OR "biologisch koffie omhulsel"~22 OR "biodegradeerbare koffie omhulsel"~22 OR "biologisch afbreekbaar koffie magazijn"~22 OR "biologisch koffie magazijn"~22) OR PL\_AB:(("ulegający biodegradacji papieros kawy kapsułki"~22 OR "biodegradowalny kawy kapsułki"~22 OR "biologicznemu kawy kapsułki"~22 OR "rozkładowi kawy kapsułki"~22 OR "podobny kawy kapsułki"~22 OR "biodegradowalna kawy kapsułki"~22 OR "ulegający biodegradacji papieros kawy kapsuła"~22 OR "biodegradowalny kawy kapsuła"~22 OR "ulegający biodegradacji papieros kawy dostosowana"~22 OR "biodegradowalny kawy dostosowana"~22 OR "ulegający biodegradacji papieros kawy wkład"~22 OR "biodegradowalny kawy wkład"~22 OR "biologicznemu kawy kapsuła"~22 OR "rozkładowi kawy kapsuła"~22) OR PT\_AB:(("cápsula de café biodegradáveis"~22 OR "cápsula de café biodegradáveis"~22 OR "cápsula de café biodegradacao"~22 OR "cápsula de café biodegradação"~22) OR RU\_AB:(("биоразрушаемых кофейная капсула"~22 OR "биоразрушаемых капсула с кофе"~22 OR "биоразлагаемый кофейная капсула"~22 OR "биоразлагаемый капсула с кофе"~22 OR "биологически разлагающийся кофейная капсула"~22 OR "биологически разлагающийся капсула с кофе"~22 OR "биodeградируемого кофейная капсула"~22 OR "биodeградируемого капсула с кофе"~22 OR "от биоразрушений древесных материалов кофейная капсула"~22 OR "от биоразрушений древесных материалов капсула с кофе"~22 OR "биodeградации кофейная капсула"~22 OR "биodeградации капсула с кофе"~22 OR "способных кофейная капсула"~22 OR "способных капсула с кофе"~22) OR SV\_AB:(("nedbrytbara kaffe patron"~22 OR "bionedbrytbara kaffe patron"~22 OR "biodegraderbara kaffe patron"~22 OR "biologiskt nedbrytbart kaffe patron"~22 OR "biodegradabelt kaffe patron"~22 OR "nedbrytbara kaffe kapseltyp"~22 OR "nedbrytbara kaffe kapsel"~22 OR "bionedbrytbara kaffe kapseltyp"~22 OR "bionedbrytbara kaffe kapsel"~22 OR "nedbrytbara kaffe ramställd"~22 OR "bionedbrytbara kaffe ramställd"~22 OR "biodegraderbara kaffe kapseltyp"~22 OR "biodegraderbara kaffe kapsel"~22) OR ZH\_AB:(("可生物 咖啡胶囊"~22 OR "生物降解 咖啡胶囊"~22 OR "生物分解型 咖啡胶囊"~22 OR "降解 咖啡胶囊"~22 OR "生物分解性 咖啡胶囊"~22 OR "一种生物降解 咖啡胶囊"~22)) AND ICF:(("B82B 3" OR "C06F 1" OR "C06F 3" OR A21 OR A22 OR A23 OR A24 OR A45 OR A46B OR A46D OR A47 OR B02 OR B07 OR B23 OR B24 OR B25 OR B26 OR B27 OR B28 OR B29 OR B31 OR B32 OR B3? OR B65 OR B66 OR B67 OR C03 OR C04 OR C12 OR C13 OR C14 OR E05 OR E06)) Office(s):all Language:EN Stemming: true

Analysis									
Countries		IPC		Inventor		Applicant		Pub Date	
Name	No	Name	No	Name	No	Name	No	Date	No
PCT	3	B65D	13	Adam Mekeel Mack	2	FI-PLAST S.R.L.	2	2010	1
European Patent Office	2	B65B	6	Alan Scott Crarer	2	STARBUCKS CORPORATION D/B/A STARBUCKS COFFEE COMPANY	2	2014	3
Republic of Korea	2	A47J	4	Amanda Juris	2	Starbucks Corporation	2	2015	3
United States	2	A23F	2	DI FIORE CARMINE	2	Starbucks Corporation	2	2016	2
Australia	1	B29B	1	Farid Sadeghi	2	FI PLAST S R L	1	2017	7
Canada	1	B29C	1	Izaak Koller	2	FI-PLAST S R L	1	2018	2
China	1	B29K	1	Jeffrey Jack Fleming	2	FRANCESCO SPIGNESI	1		
		C08 L	1	Kathleen J. Ireland	2	SPC SUNFLOWER PLASTIC COMPOUND GMBH	1		

Sort by: Relevance View All List Length 10 Machine translation

Int.Class	Appl.No	Title	Ctr	PubDate
1. 106573712		Compound between a thermoplastic polymer and a filler for producing films for packaging foodstuffs, in particular coffee capsules	CN	19.04.2017
B65D 65/46	201580028450.4	FI PLAST S R L	MARIANI GIANLUIGI	
<p>Biodegradable and compostable capsule to be used in automatic apparatuses for producing coffee or, more in general, hot and/or cold beverages, such capsule being suitable to contain infusion products for producing beverages, wherein the infusion or dilution product (2) is contained in a containing shell (1) closed through a membrane (3), which is a single layer and is made of a material comprising a biodegradable and compostable polymer, or a mixture of biodegradable and compostable polymers, and a percentage of fillers included between 15% and 90%, with the following composition: from 10% to 85% of one and/or a mixture of aliphatic or aliphatic-aromatic polyesters containing from 15% to 90% of one and/or more fillers comprising small particles whose granulometry D50 is included between 1 micron and 200 micron, surface or non-surface treated, which do not interact with the beverage delivered through the capsule.</p>				
2. 202016104950		Hermetisch verschließbare Portionspackung oder hermetisch verschließbarer Portionsbeutel mit einer biologisch abbaubaren Kaffeekapsel oder einem biologisch abbaubaren Kaffeepad	DE	12.01.2017
B65D 85/804	202016104950	Spignesi Francesco		
<p>Hermetisch verschließbare Portionspackung oder hermetisch verschließbarer Portionsbeutel mit einer biologisch abbaubaren Kapsel oder einem biologisch abbaubaren Pad, die bzw. das gemahlene Kaffee enthält, dadurch gekennzeichnet, dass die Portionspackung oder der Portionsbeutel aus biologisch abbaubarem Material besteht.</p>				
3. 2016519580		延伸可能な飲料カートリッジ及び方法	JP	07.07.2016
A47J 31/36	2016500475	スターバックス・コーポレイション	アイザック コラー	

本実施態様は、一般に、シングルサーブ式コーヒー抽出機と共に使用するためのシングルサーブ式飲料カートリッジに関する。いくつかの実施態様では、カートリッジは、本体部分と、第1のフィルタエレメントと、第2のフィルタエレメントとを有している。カートリッジは一杯分のコーヒー又は別の飲料の成分又は前駆物質を含むことができる。カートリッジは、生分解可能な又は可堆肥化可能な材料から形成することができる。いくつかの実施態様では、小径の多孔質のフィルタエレメントは、カートリッジのコーヒー抽出時に使用される。本実施態様は、一般的に、シングルサーブ式コーヒー抽出機と共に使用するためのシングルサーブ式飲料カートリッジに関する。いくつかの実施態様では、カートリッジは、本体部分と、第1のフィルタエレメントと、第2のフィルタエレメントとを有している。カートリッジは一杯分のコーヒー又は別の飲料の成分又は前駆物質を含むことができる。カートリッジは、生分解可能な又は可堆肥化可能な材料から形成することができる。いくつかの実施態様では、小径の多孔質のフィルタエレメントは、カートリッジのコーヒー抽出時に使用される。





# Why is CLIR useful?

- A) Search full text collections simultaneously in many foreign languages
- B) Improve significantly the number of relevant results without increasing significantly the number of irrelevant results
- C) Have confidence in your searches:  
No black box: users have access to the CLIR generated Boolean queries (albeit complex) and have the full control on them
- D) Have a responsive system even for complex queries

Results 1-10 of 805,653 for Criteria:FP:((EN\_AB:(("car" OR "auto" OR "automobile" OR "vehicles" OR "vehicule") OR DE\_AB:(("Auto" OR "Fahrzeug" OR "Krafftfahrzeug" OR "Kabine" OR "Automobil" OR "Vehicles" OR "Kfz" OR "Car" OR "Personenkraftwagen" OR "Waggon" OR "PKW" OR "Autos" OR "Aufzugskabine" OR "Wagen") OR ES\_AB:(("cabina" OR "automóvil" OR "vehículo" OR "coche" OR "vehículo automóvil" OR "vagón" OR "carro" OR "auto" OR "vehí" OR "automático") OR FR\_AB:(("véhicule" OR "voiture" OR "automobile" OR "auto" OR "wagon" OR "cabine" OR "véhicule automobile" OR "plates" OR "vehicule" OR "hicule" OR "véhicule" OR "wagon porté automobiles" OR "automatique" OR "engin") OR IT\_AB:(("veicoli" OR "autoveicolo" OR "piamento" OR "carro" OR "autovettura" OR "carrozze" OR "avviamento" OR "parcheggi" OR "rotoli" OR "automobile" OR "altra" OR "filo" OR "perfezionamento" OR "automobilistico") OR JA\_AB:(("自動車" OR "かご" OR "車両" OR "車載" OR "車輛" OR "力一" OR "の連絡" OR "乗物" OR "乗り物" OR "横向き" OR "間の連絡" OR "車内" OR "オート") OR KO\_AB:(("차량용" OR "차량" OR "자동차용" OR "자동차" OR "하고" OR "철도차량" OR "자동" OR "철도" OR "카") OR NL\_AB:(("voertuigen" OR "wagen" OR "gen" OR "auto" OR "wegvoertuigen" OR "drager" OR "bufferkoppeling" OR "spoorwerkplaats" OR "vervoermiddelen" OR "autoradio" OR "een" OR "voertuigdakopening" OR "motorvoertuigen" OR "automobiel") OR PT\_AB:(("automóvel" OR "veículos" OR "veiculos" OR "veículos" OR "cabina" OR "gaiola" OR "carros" OR "vagão" OR "vagões" OR "automóveis" OR "viatura automóvel" OR "caminhão auto") OR RU\_AB:(("автомобилѧ" OR "вагона" OR "транспортных средств" OR "средства" OR "парковки" OR "автомобильных" OR "транспорта" OR "техники" OR "авто" OR "автоматической") OR SV\_AB:(("fordon" OR "förbundna" OR "jernvegsfordon" OR "bil" OR "apparater" OR "stopp" OR "hopsättning" OR "personbils" OR "ytterbelysningar" OR "en bils" OR "karosstaket" OR "tendning" OR "taendning") OR ZH\_AB:(("轿厢" OR "汽车" OR "车辆" OR "车载" OR "机动车" OR "自动" OR "车用" OR "工具")) AND ICF:(B28 OR B60 OR B61 OR B62 OR B66 OR C04 OR E0? OR F17 OR G09D)) Office(s):all Language:EN Stemming: true



Refine Search

Q:3 which expansion mode was used to obtain this result list?

A

Automatic

B

Supervised

Q:3: which expansion mode was used to obtain this result list?

A Automatic

C Supervised

Q:2: which languages are supported by CLIR?

- A Chinese
- B Swedish
- C Korean
- D French

Q:2: which languages are supported by CLIR?

- A** Chinese
- B** Swedish
- C** Korean
- D** French

# How to make the most of out CLIR?

- Expansion modes:
  - 1meaning keyword = AUTOMATIC
  - All other queries = SUPERVISED
- Variants/synonyms
  - words to be included in search results
  - too many results → delete generic variants



# How to make the most of out CLIR?

- Parameters:

- 1. Title and abstract: unconstrained distance
- 2. Claims: sentence/paragraph distance
- 3. Description: sentence/paragraph distance

- Stemming recommended

# How was it developed?

- Compilation of long lists of titles in language pairs
- Creation of in-house extraction methodology
- Tool learns statistical bilingual dictionaries of titles

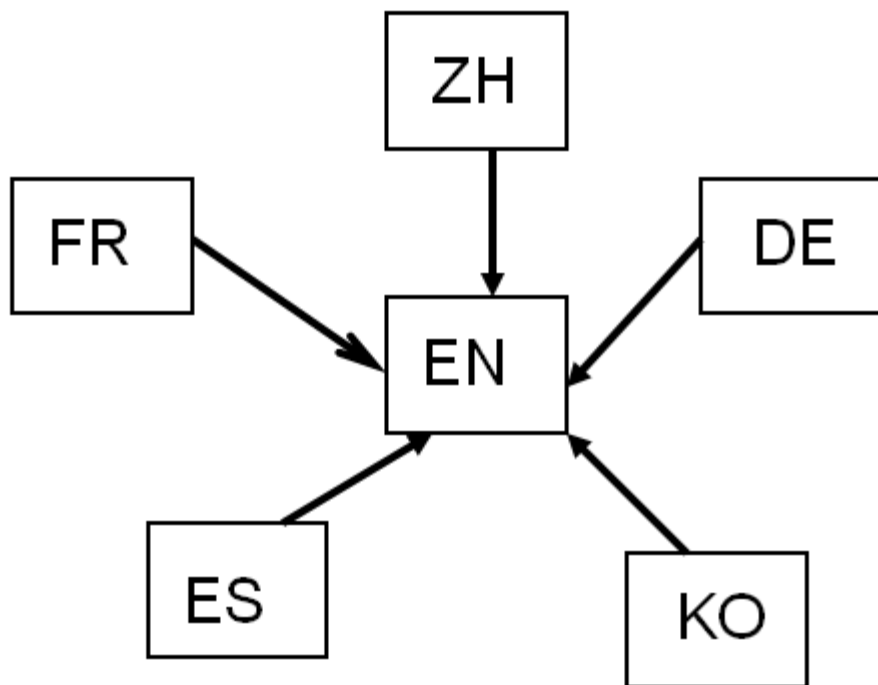

# Quality of dictionaries



Chinese  
English  
French  
German  
Japanese



Korean  
Portuguese  
Russian  
Spanish



Dutch  
Italian  
Swedish  
Polish  
Danish

# Disambiguation

- Process of identifying the sense of a word in a sentence. [http://en.wikipedia.org/wiki/Disambiguation\\_%28disambiguation%29](http://en.wikipedia.org/wiki/Disambiguation_%28disambiguation%29)
- Applied to keywords:
  - technical domains
  - variants

- User Guide PATENTSCOPE
- User Guide: Cross Lingual Expansion
- User Guide: Chem Search
- Query Syntax
- Fields Definition
- Country Code

- How to Search
- Data Coverage
- FAQ
- Feedback&Contact
- INID codes
- Kind codes
- Tutorials
- About

tion	Ctrl
applicant	inventor

# Coverage: what is included?



## National Collections - Data Coverage

Last Update: 07.11.2018

Country	Biblio Data	Abstract	Doc images
PCT	20.10.1978 - 09.11.2018	20.10.1978 - 09.11.2018	3410922
Argentina	12.02.1965 - 01.11.2018	01.11.1990 - 01.11.2018	9741
Australia	15.01.1900 - 02.11.2018	09.01.1981 - 02.11.2018	
Bahrain	10.03.1957 - 29.09.2005	10.03.1957 - 29.09.2005	
Brazil	26.04.1972 - 17.10.2018	26.04.1989 - 17.10.2018	230198
Brunei Darussalam	15.03.1979 - 19.08.2018	01.07.1992 - 19.08.2018	
Cambodia	05.03.2015 - 12.04.2017	05.03.2015 - 12.04.2017	
Canada	12.08.1869 - 28.10.2018	07.02.1973 - 28.10.2018	

## Offices for which PCT national phase information is available in PATENTSCOPE Search Service

Where information is displayed for an office, this indicates that the applicant has requested national phase processing for the application concerned in that office. The national entry date and national reference number are supplied by the national office concerned and can be used to retrieve further details from that office, if desired. The information is updated at different frequencies, depending on the office. Therefore, absence of information for a given office does not necessarily indicate a non-entry in that office. The information displayed on the National Phase Tab is based on data supplied to WIPO by the following national patent offices:

Updated: November 8, 2018

Country	From	To	Count
African Regional Intellectual Property Organization (ARIPO)	June 30, 1996	August 5, 2008	1,077
Algeria	April 25, 2000	December 27, 2014	3,417
Armenia	April 15, 2018	September 24, 2018	2
Australia	December 4, 1997	May 27, 2018	343,389
Austria	November 27, 1980	October 11, 2018	3,335
Azerbaijan	January 21, 2016	April 21, 2017	28
Belarus	January 4, 2005	August 13, 2018	1,470
Belize	August 26, 2002	February 8, 2007	105
Bulgaria	January 5, 2004	December 18, 2007	1,252
Cambodia	December 26, 2017	December 26, 2017	1
Canada	January 31, 1990	August 23, 2018	617,130
China	January 2, 1994	August 23, 2017	667,978

C

Document/Data Type	Availability, based on International Filing Date	Notes
Latest bibliographic data available to the International Bureau	1978 to present	
International Application Status Report	July 1998 to present	
Published PCT international applications in image format	1978 to present	
Text of description and claims for applications published in:		For more information on the data format, please visit: <a href="http://patentscope.wipo.int/search/en/data_formats.jsf">http://patentscope.wipo.int/search/en/data_formats.jsf</a>
- English, French, German, Spanish or Russian	1978 to present	
- Japanese	July 2008 to present	
Priority documents	January 2001 to present	
Declarations (PCT Rule 4.17)		

## Public Global Dossier Coverage

Last Update: 24.10.2017

Data coverage for OPD services	
EPO	Patent applications filed on 01.06.1978 and onwards
JPO	Patent applications filed on 01.06.1978 and onwards
CA	Patent applications published since 01.01.2008 <b>Note:</b> Only limited sets of documents are available (examination reports and search reports) for applications published between January 2008 and September 2015.
AU	Patent applications filed after 2006
US	Patent application filed on Jan 1, 2003 and onwards. Prior to 2003, applications are available on a case by case basis.

**Options** 

**Query** | Result | Interface | Office | Translate



**Query Language**

<input type="radio"/> All	<input type="radio"/> Arabic	<input type="radio"/> Chinese	<input type="radio"/> Danish	<input checked="" type="radio"/> English
<input type="radio"/> Estonian	<input type="radio"/> French	<input type="radio"/> German	<input type="radio"/> Hebrew	<input type="radio"/> Indonesian
<input type="radio"/> Italian	<input type="radio"/> Japanese	<input type="radio"/> Korean	<input type="radio"/> Polish	<input type="radio"/> Portuguese
<input type="radio"/> Russian	<input type="radio"/> Spanish	<input type="radio"/> Swedish	<input type="radio"/> Thai	<input type="radio"/> Vietnamese

**Stem**

**Sort by:**  Relevance  Pub Date Desc  Pub Date Asc  App Date Desc  App Date Asc

**List Length**  10  50  100  200

 Save  Reset



# Options - results

Options

Query Result Interface Office Translate

**Result List Language**

Query Language  English  Spanish  Korean  Vietnamese  
 Hebrew  Portuguese  French  German  Japanese  
 Russian  Chinese  Italian  Polish  Danish  
 Swedish  Arabic  Estonian  Indonesian  Thai

**Displayed Fields**

Application Number  Publication Date  Abstract  Applicant Name  
 Int. Class  Image  Inventor Name

**Chart/Graph**

Table  Graph

**Group by \***

None  Offices of NPEs  IPC code  Applicants  
 Inventors  Filing Dates  Publication Dates  Countries

**No of Items/Group**

10

**Download Fields**

NPEs

Save Reset

Text of description and claims for applications published in: For more information on the data format,

# Options - results

Options

Query Result Interface Office Translate

Result List Language

Query Language  English  Spanish  Korean  Vietnamese  
 Hebrew  Portuguese  French  German  Japanese  
 Russian  Chinese  Italian  Polish  Danish  
 Swedish  Arabic  Estonian  Indonesian  Thai

Displayed Fields

Application Number  Publication Date  Abstract  Applicant Name  
 Int. Class  Image  Inventor Name

Chart/Graph

Table  Graph

Group by \*

None  Offices of NPEs  IPC code  Applicants  
 Inventors  Filing Dates  Publication Dates  Countries

No of Items/Group

10

Download Fields

NPEs

Save Reset

Refine Search

CHEM:((EN\_TI:( "car" OR "wagon" ) OR EN\_AB:( "car" OR "wagon" )) OR (DA\_TI:( "godsvogn" OR "vogn" ))

Search



Analysis

Sort by: Relevance

View All

List Length 10

Machine translation

Side-by-side

Int.Class	Title	Applicant	Ctr	PubDate
584. 2012169824	METHOD AND DEVICE FOR UNIFORMIZING AIR SPRING PRESSURE OF RAILWAY WAGON AND		IP	02.09.2013

**584. 2012169824 METHOD AND DEVICE FOR UNIFORMIZING AIR SPRING PRESSURE OF RAILWAY WAGON AND**

B61F 5/10 2012036180 HITACHI LTD INOUE SHINGO

PROBLEM TO BE SOLVED: To provide a method and a device which uniformize pressure of air springs provided in a carriage included in a first railway vehicle when transporting a second railway vehicle traveling on one track by loading it on the one track laid on the floor surface of the first railway vehicle traveling on the other track, and to provide a railway wagon including the device.

SOLUTION: Air pressures of first air springs 52, 53 provided in first carriages 50, 50 while a railway vehicle is loaded are measured by first pressure sensors 57, 57. Based on an average value of the pressures, aperture of an electromagnet valve 78 is adjusted with a control device 79, supply of pressure air to second air springs 72, 73 provided in an intermediate second carriage 70 is controlled and is averaged to be equal to the pressures of the first air springs 52, 53. Axle weight of each wheel set of a railway wagon can thereby be equalized.

COPYRIGHT: (C)2013,JPO&INPIT

**582. WO/2011/138416 COMMUNICATION BUS FOR MULTI-PART TRACK BASED VEHICLE**

B61L 15/00 PCT/EP2011/057247 SIEMENS AKTIENGESELLSCHAFT GRIMM, Wolfgang

The invention relates to a track based vehicle (1), in particular a railway vehicle, having a plurality of cars (10, 20, 30, 40) and a technical communication bus extending along the cars (10, 20, 30, 40). In order to ensure extensive availability of the technical communication bus even in case of fire, the track based vehicle according to the invention is implemented such that the technical communication bus comprises two transmission lines (50, 60) extending along the cars (10, 20, 30, 40), the two transmission lines (50, 60) are electrically interconnected by means of a control unit (70), and the control unit (70) is designed to autonomously electrically separate the transmission lines (50, 60) in case of a fire.

**583. 2233378 Head wagon of a rail vehicle**

B61C 17/04 10157374 SIEMENS AG VOGELY THOMAS

The carriage has a driver's cab provided with a control panel (1), where the control panel has an impact area for stomach and/or chest of an operator. The impact area is formed by a flexibly designed stem (2) of the control panel. The rack has a wedge element (3) positioned on the control panel and a deformation unit (4) arranged between the wedge element and the control panel. The deformation unit is designed such that it is spread during application of the wedge element with force. (Further information about the control panel)

# Options - results

**Options**

**Query** **Result** **Interface** **Office** **Translate**

**Result List Language**

Query Language  English  Spanish  Korean  Vietnamese  
 Hebrew  Portuguese  French  German  Japanese  
 Russian  Chinese  Italian  Polish  Danish  
 Swedish  Arabic  Estonian  Indonesian  Thai

**Displayed Fields**

Application Number  Publication Date  Abstract  Applicant Name  
 Int. Class  Image  Inventor Name

**Chart/Graph**  Table  Graph

**Group by \***

None  Offices of NPEs  IPC code  Applicants  
 Inventors  Filing Dates  Publication Dates  Countries

**No of Items/Group** 10

**Download Fields**  NPEs

**Save** **Reset**

Text of description and claims for applications published in: For more information on the data format,

Analysis



Countries IPC Inventor Applicant Pub Date

Countries



UN  
KM")  
碎"



Analysis



Countries IPC Inventor Applicant Pub Date

Countries

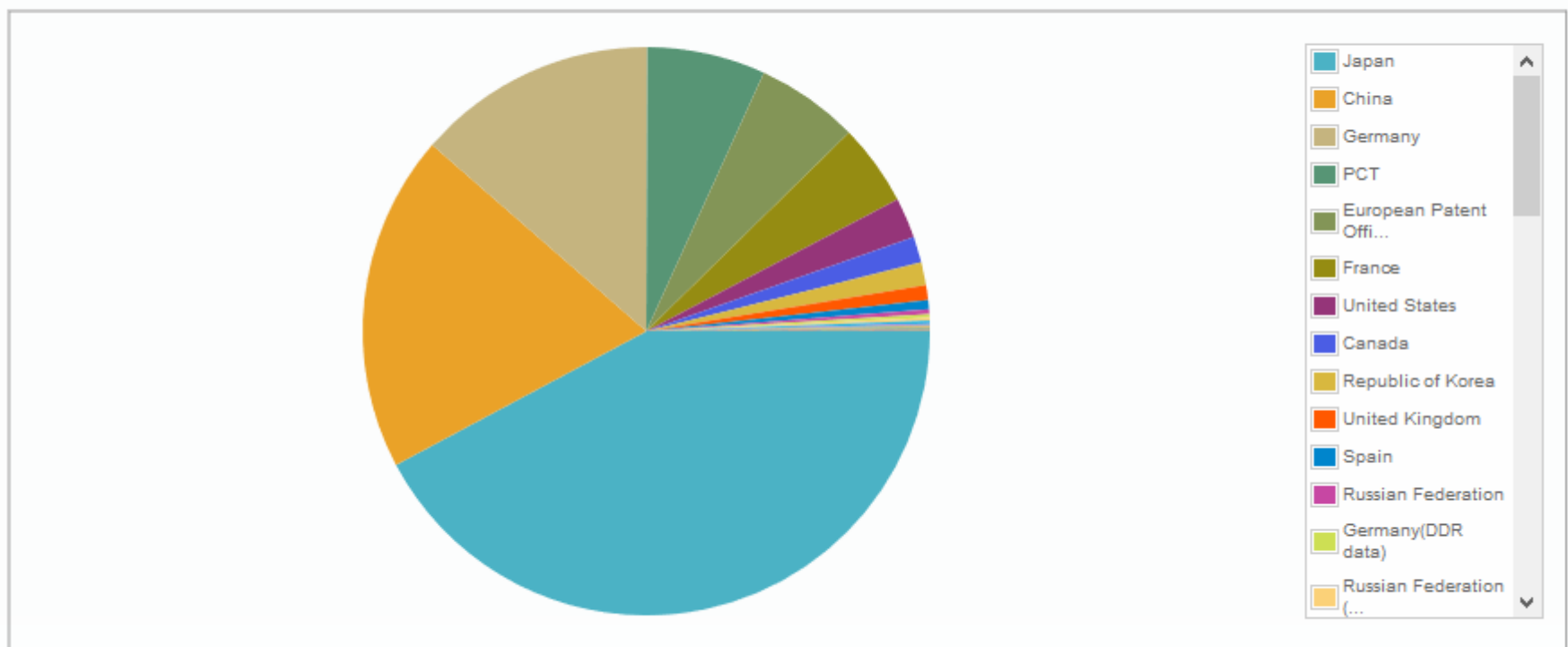

# Options - results

Options

Query Result Interface Office Translate

Result List Language

Query Language  English  Spanish  Korean  Vietnamese  
Hebrew  Portuguese  French  German  Japanese  
Russian  Chinese  Italian  Polish  Danish  
Swedish  Arabic  Estonian  Indonesian  Thai

Displayed Fields

Application Number  Publication Date  Abstract  Applicant Name  
 Int. Class  Image  Inventor Name

Chart/Graph

Table  Graph

Group by \*

None  Offices of NPEs  IPC code  Applicants  
 Inventors  Filing Dates  Publication Dates  Countries

No of Items/Group

10

Download Fields

NPEs

Save Reset

text of description and claims for applications published in: For more information on the data format,

Analysis



Countries		IPC		Inventor		Applicant		Pub Date	
Name	No	Name	No	Name	No	Name	No	Date	No
Japan	1,291,008					TOYOTA MOTOR CORP	33,846		
China	586,571	B60R	244,649	赵福全	3,040	BOSCH GMBH ROBERT	22,223	1993	69,390
Germany	418,504	B62D	146,641	THE INVENTOR HAS WAIVED THE RIGHT TO BE MENTIONED	1,537	DENSO CORP	21,182	1994	69,080
PCT	206,353	B60K	136,846	小倉 敏男	1,489	CANON INC	20,942	1995	63,380
European Patent Office	179,427	G06F	90,452	杨健	1,481	HONDA MOTOR CO LTD	20,213	1996	61,517
France	142,190	H01L	89,668	李书福	1,425	MATSUSHITA ELECTRIC IND CO LTD	18,998	1997	64,115
United States	70,249	H04N	77,952	gleich Anmelder	1,282	トヨタ自動車株式会社	18,297	1998	70,930
Canada	45,151	B60N	75,940	Antrag auf Nichtnennung	1,199	TOSHIBA CORP	15,838	1999	74,446
		B60T	71,718					2000	76,088

# Options - results

Options

Query Result Interface Office Translate

Result List Language

Query Language  English  Spanish  Korean  Vietnamese  
Hebrew  Portuguese  French  German  Japanese  
Russian  Chinese  Italian  Polish  Danish  
Swedish  Arabic  Estonian  Indonesian  Thai

Displayed Fields

Application Number  Publication Date  Abstract  Applicant Name  
 Int. Class  Image  Inventor Name

Chart/Graph

Table  Graph

Group by \*

None  Offices of NPEs  IPC code  Applicants  
 Inventors  Filing Dates  Publication Dates  Countries

No of Items/Group 10

Download Fields  NPEs

Save Reset

text of description and claims for applications published in:

For more information on the data format,



Analysis

Country	Count	IPC Class	Count	IPC Class	Count	IPC Class	Count	Year	Count
European Patent Office	3,385,688	A61P	1,505,103	不公告发明人	17,319	LG ELECTRONICS INC.	139,804	2014	3,088,805
France	2,436,131	C07D	1,403,650	VERZICHT DES ERFINDERS AUF NENNUNG	16,363	International Business Machines Corporation	132,067	2015	3,193,504
United Kingdom	2,361,977	A61B	1,211,302	gleich Anmelder	14,652	삼성전자주식회사	124,983	2016	3,691,589
Canada	2,348,251	B65D	1,151,407	WANG WEI	14,186	SONY CORP	124,704	2017	3,994,133
Australia	1,677,106					TOSHIBA CORP	121,644	2018	3,711,123
Spain	1,530,936								
Russian Federation (USSR data)	1,409,666								
Russian Federation	1,125,131								
Brazil	745,073								

# Options - interface



The screenshot shows a software options dialog box titled "Options" with a close button in the top right corner. The "Interface" tab is selected, and the settings are as follows:

Option	Value
Default Search Form	Simple
Default Tab Search Form	Front Page
Interface Language	English
Multiple Windows Interface	<input type="checkbox"/>
Tooltip Help	<input type="checkbox"/>
IPC Tooltip Help	<input checked="" type="checkbox"/>
Instant Help	<input checked="" type="checkbox"/>
Expanded Query	<input checked="" type="checkbox"/>

At the bottom of the dialog, there are two buttons: "Save" and "Reset".

# Options: office - translate

Analysis

Machine translation  

Appl.No	Title	Applicant	Ctr	
16029956	PRODUCING COKE, AND COKE	HA KOBE SEIKO SHO(KOBE STEEL,LTD)	US	08.
15972919		Codexis, Inc.	US	08.

Wipo Translate  
Google Translate  
Bing/Microsoft Translate  
Baidu Translate

The mixture includes: an ashless coal; an oxidized ashless coal obtained by an oxidation treatment... parts by mass of a total of the ashless coal, the oxidized ashless coal and the raw petroleum coke, a content of the ashless coal is from 5 to 4... e oxidized ashless coal is from 30 to 70 parts by mass.

ered ligase polypeptides and compositions thereof, as well as polynucleotides encoding the engineered ligase polypeptides. The invention... e engineered ligase polypeptides for diagnostic and other purposes.

IT\_AB:(("piamento" OR "cabina" OR "vagopne" OR "vagopne" OR "vagone")) OR (JA\_Tl:(("車両" OR "車内" OR "ワゴン" OR "貨車" OR "Iによる")) OR JA\_AB:(("車両" OR "車内" OR "ワゴン" OR "貨車" OR "Iによる")) OR (KO\_Tl:(("전동차용" OR "차량설비" OR "철도차량용 기기" OR "루프" OR "운전실의")) OR KO\_AB:(("전동차용" OR "차량설비" OR "철도차량용 기기" OR "루프" OR "운전실의")) OR (NL\_Tl:(("gen" OR "wagon")) OR NL\_AB:(("gen" OR "wagon")) OR (PL\_Tl:(("wagonu" OR "wóz" OR "składający" OR "wagonowych" OR "drogowo")) OR PL\_AB:(("wagonu" OR "wóz" OR "składający" OR "wagonowych" OR "drogowo")) OR (PT\_Tl:(("vagão" OR "carro")) OR PT\_AB:(("vagão" OR "carro")) OR (RU\_Tl:(("вагона" OR "вагонетки")) OR RU\_AB:(("вагона" OR "вагонетки")) OR (SV\_Tl:(("vagn" OR "rälsgående")) OR SV\_AB:(("vagn" OR "rälsgående")) OR (ZH\_Tl:(("车厢" OR "货车" OR "轿车" OR "车用" OR "换车" OR "汽车" OR "阻")) OR ZH\_AB:(("车厢" OR "货车" OR "轿车" OR "车用" OR "换车" OR "汽车" OR "阻")))) Office(s):all Language:EN Stemming:true

Refine Search FP:(("EN\_Tl:(("car" OR "wagon") OR EN\_AB:(("car" OR "wagon")) OR (DA\_Tl:(("godsvogn" OR "vogn" OR ... Search RSS 10x

Analysis									
Countries		IPC		Inventor		Applicant		Pub Date	
Name	No	Name	No	Name	No	Name	No	Date	No
Japan	1,291,008					TOYOTA MOTOR CORP	33,846		
China	586,571	B60R	244,649	赵福全	3,040	BOSCH GMBH ROBERT	22,223	1993	69,390
Germany	418,504	B62D	146,641	THE INVENTOR HAS WAIVED THE RIGHT TO BE MENTIONED	1,537	DENSO CORP	21,182	1994	69,080
PCT	206,353	B60K	136,846	小倉 敏男	1,489	CANON INC	20,942	1995	63,380
European Patent Office	179,427	G06F	90,452	杨健	1,481	HONDA MOTOR CO LTD	20,213	1996	61,517
France	142,190	H01L	89,668	李书福	1,425	MATSUSHITA ELECTRIC IND CO LTD	18,998	1997	64,115
United States	70,249	H04N	77,952	gleich Anmelder	1,282	IND CO LTD		1998	70,930
Canada	45,151	B60N	75,940	Antrag auf Nichtnennung	1,199	トヨタ自動車株式会社	18,297	1999	74,446
		B60T	71,718			TOSHIBA CORP	15,838	2000	76,088

Sort by: Relevance View All List Length 10 Machine translation Side-by-side

Title	PubDate	Inventor
<b>WAGON</b>	WO	03.12.1998
DAIML	SCHUNKE, Hilmar	
...e engine (1) and an a... ...following wagon body...		traveling gear. In order to facilitate axle-load bogie by means of separate elastic support

2. WO/2002/081283 FREIGHT CAR WO 17.10.2002  
B61D 3/04 PCT/DE2002/001176 FORSCHUNGSZENTRUM JÜLICH GMBH MARQUARDT, Martin

The invention relates to a freight car (3) for transporting, for instance trucks. The freight car (3) comprises a platform (2) that can rotate about the vertical axis. The surface of the platform to be driven onto has a height above the top surface of the rail (12) that complies with the loading gauge of the country or countries in which transport takes place. The surface of the platform (2) to be driven on preferably has a maximum height of 700 mm, more particularly 310 mm above the top surface of the rail (12). This ensures that the height of the transport including the standard height truck does not exceed German or international loading gauges. The existing loading gauge in Germany of 4680 mm and the existing international loading gauge of 4310 mm height are thereby observed. Standard-height trucks can thus be transported on the inventive freight cars (3) under overhead lines or through train tunnels. Loading trucks onto and unloading trucks from the inventive freight cars (3) can be carried out in any city where paved surfaces are available, for instance, also in grade crossings.

# Future/past webinars

[wipo.int/patentscope/en/webinar](https://wipo.int/patentscope/en/webinar)

## PATENTSCOPE Webinars

WIPO offers free online seminars (webinars) to deliver information, training and updates on the [PATENTSCOPE Search System](#). If you or your organization are interested in a webinar on a specific topic, please [contact us](#).

### Quick links

- [Frequently asked questions](#)

## Register for upcoming webinars

- [Complex queries in the PATENTSCOPE search system](#) (October 23 or 25)
- [Overview of the PATENTSCOPE search system](#) (November 13 or 15)
- [Retrospective of 2018 and plans for 2019](#) (December 18 or 20)

### System requirements

- PC: Windows® 8, 7, Vista, XP or 2003 Server
- Mac®: Mac OS® X 10.6 or newer
- Mobile: iPhone®, iPad®, Android™ phone or Android & tablet

## Past events

Title	Description	Date
CLIR <a href="#">PPT</a>	How to find information in languages you don't know in PATENTSCOPE	September 2018

# Searches

The screenshot displays the top navigation bar of the WIPO search interface. It includes a search bar with a magnifying glass icon, and navigation links for "Search", "Browse", "Translate", and "News". On the right side of the navigation bar, there are icons for a user profile, settings, and help. A dropdown menu is open over the search bar, listing the following search options: "Simple" (highlighted), "Advanced Search", "Field Combination", "Cross Lingual Expansion", and "Chemical compounds (login required)". Below the navigation bar, a blue banner indicates that the database contains "2 million patent documents including 3.5 million published international patent applications (PCT). Detailed coverage". A search input field is visible with a question mark icon and the text "Office:All". To the right of the input field is a "Search" button. At the bottom of the page, a partial text snippet reads: "PCT Publication 45/2040 (00 44 2040) is now available. The next publication date is scheduled as follows: Class number 40/2040 (45 44 2040) ...".

# Simple search



PATENTSCOPE

Search International and National Patent Collections

Mobile | Deutsch | Español | Français | 日本語 | 한국어 | Português | Русский | 中文 | العربية |

WORLD INTELLECTUAL PROPERTY ORGANIZATION

Search | Browse | Translate | News



Home > IP Services > PATENTSCOPE

## Simple Search

Using PATENTSCOPE you can search 72 million patent documents including 3.5 million published international patent applications (PCT). Detailed coverage information can be found here

Front Page



Office:All

Search

Front Page

Any Field

Full Text

English Text

ID/Number

Int. Classification(IPC)

Names

Dates

15/2018 (08.11.2018) is now available. The next publication date is scheduled as follows: Gazette number 46/2018 (15.11.2018). [More](#)

# 8 predefined fields

- Front Page
- Any Field
- Full Text
- English Text
- ID/Number
- Int. Classification(IPC)
- Names
- Dates

PCT Biblio. Data | Description | Claims | Drawings | National Phase | Notices | Documents

Latest bibliographic data on file with the International Bureau [Submit observation](#) [PermaLink](#)

**Pub. No.:** WO/2018/203209 **International Application No.:** PCT/IB2018/052976  
**Publication Date:** 08.11.2018 **International Filing Date:** 30.04.2018

**IPC:** E03D 9/00 (2006.01), A46B 13/02 (2006.01), A46B 17/06 (2006.01), A47K 17/00 (2006.01), E03D 9/03 (2006.01) [?](#)

**Applicants:** JOUKOV, Herman [IL/IL]; IL  
ZUKOV, Oleg [IL/IL]; IL

**Inventors:** JOUKOV, Herman; IL  
ZUKOV, Oleg; IL

**Agent:** VAPNIARSKY, Andrey; IL

**Priority Data:** 62/492.303 01.05.2017 US

**Title**  
(EN) SYSTEMS AND METHODS OF CLEANING TOILETS  
(FR) SYSTÈMES ET PROCÉDÉS DE NETTOYAGE DE TOILETTES

**Abstract:**  
(EN) Systems and methods of cleaning toilets are described; the system includes a structural frame, a foldable arm extendible from the structural frame and a rotatable brush, accommodated while being folded within and retracted into the foldable arm, at an idle state, while protruded from the foldable arm and being sprawl, during the operation of a cleansing cycle.  
(FR) L'invention concerne des systèmes et des procédés de nettoyage de toilettes. Le système comprend: une structure; un bras pliable extensible à partir de la structure; et une brosse rotative qui, à l'état de repos, est logée pliée et rentrée à l'intérieur du bras pliable, duquel elle se déploie en saillie au cours d'un cycle de nettoyage.

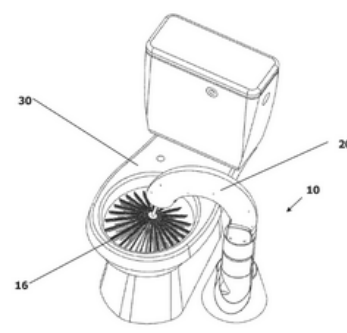



# Searches

The screenshot displays the top navigation bar of the WIPO search interface. It includes links for 'Search', 'Browse', 'Translate', and 'News'. On the right side, there are icons for user profile, settings, and help. A dropdown menu is open over the 'Search' link, listing the following options: 'Simple', 'Advanced Search', 'Field Combination' (which is highlighted), 'Cross Lingual Expansion', and 'Chemical compounds (login required)'. Below the navigation bar, a search bar is visible with a 'From Page' dropdown on the left, a search input field, a help icon, and a 'Search' button. The text 'Office:All' is positioned to the left of the search button. A snippet of a search result is visible below the search bar, mentioning '2 million patent documents including 3.5 million published international patent applications (PCT). Detailed coverage'.

Field Combination

	Front Page	=	<input type="text"/>	?
AND	WIPO Publication Number	=	<input type="text"/>	?
AND	Application Number	=	<input type="text"/>	?
AND	Publication Date	=	<input type="text"/>	?
AND	English Title	=	<input type="text"/>	?
AND	English Abstract	=	<input type="text"/>	?
AND	Applicant Name	=	<input type="text"/>	?
AND	International Class	=	<input type="text"/>	?
AND	Inventor Name	=	<input type="text"/>	?
AND	Office Code	=	<input type="text"/>	?
AND	English Description	=	<input type="text"/>	?
AND	English Claims	=	<input type="text"/>	?
AND	Inventor Name	Is Empty:	<input checked="" type="radio"/> N/A <input type="radio"/> Yes <input type="radio"/> No	
AND	Licensing availability	=	<input type="checkbox"/>	

Language: English Stem:  Office: + All

(+) Add another search field | (-) Reset search fields  Tooltip Help

Q Search

Reset

Field Combination

	Front Page	=		?
AND	English Text	=	phone	?
AND	Applicant Name	=	apple	?
AND	Publication Date	=	[2008 TO 2010]	?
AND	English Title	=		?
AND	English Abstract	=		?
AND	Applicant Name	=		?
AND	International Class	=		?
AND	Inventor Name	=		?
AND	Office Code	=		?
AND	English Description	=		?
AND	English Claims	=		?
AND	Inventor Name	Is Empty:	<input checked="" type="radio"/> N/A <input type="radio"/> Yes <input type="radio"/> No	
AND	Licensing availability	=	<input type="checkbox"/>	

Language: English Stem:  Office: + All

(+) Add another search field | (-) Reset search fields  Tooltip Help

2,068 results

## Field Combination

	Front Page	=	<input type="text"/>	?
AND	WIPO Publication Number	=	<input type="text"/>	?
AND	Application Number	=	<input type="text"/>	?
AND	Publication Date	=	<input type="text"/>	?
AND	English Title	=	<input type="text"/>	?
AND	English Abstract	=	<input type="text"/>	?
AND	Applicant Name	=	<input type="text"/>	?
AND	International Class	=	<input type="text"/>	?
AND	Inventor Name	=	<input type="text"/>	?
AND	Office Code	=	<input type="text"/>	?
AND	English Description	=	<input type="text"/>	?
AND	English Claims	=	<input type="text"/>	?
AND	Inventor Name	Is Empty:	<input checked="" type="radio"/> N/A <input type="radio"/> Yes <input type="radio"/> No	
AND	Licensing availability	=	<input type="checkbox"/>	

Language:  Stem:  Office:  All

(+) Add another search field | (-) Reset search fields  Tooltip Help

**Field Combination**

AND	Front Page	=		?
AND	WIPO Publication Number	=		?
AND	National Phase Entry Date	=		?
OR	National Phase Entry Type	=		?
AND	National Publication Number	=		?
AND	Office Code	=		?
AND	National Phase Office Code	=		?
AND	Prior PCT Application Number	=		?
AND	Prior PCT WO Number	=		?
AND	Priority All Data	=		?
AND	Priority Country	=		?
AND	English Description	=		?
AND	English Claims	=		?
AND	Inventor Name	=	Is Empty: <input checked="" type="radio"/> N/A <input type="radio"/> Yes <input type="radio"/> No	?
AND	Licensing availability	=	<input type="checkbox"/>	

Language: English Stem:  Office: + All

(+) Add another search field | (-) Reset search fields  Tooltip Help

- ◀ "electric car"~50
- ◀ Smith or Klein
- ◀ WO201000001
- ◀ EP2012001709
- ◀ "sol\* panel"~5
- ◀ elect?icit?
- ◀ electric^10 and car^3

# Exercise

- Enter the following keywords + date in appropriate fields:
  - phone
  - Apple
  - 2008

Field Combination

	Front Page	=		?
AND	English Text	=	phone	?
AND	Applicant Name	=	apple	?
AND	Publication Date	=	2008	?
AND	English Title	=		?
AND	English Abstract	=		?
AND	Applicant Name	=		?
AND	International Class	=		?
AND	Inventor Name	=		?
AND	Office Code	=		?
AND	English Description	=		?
AND	English Claims	=		?
AND	Inventor Name	Is Empty:	<input checked="" type="radio"/> N/A <input type="radio"/> Yes <input type="radio"/> No	
AND	Licensing availability	=	<input type="checkbox"/>	

Language: English Stem:  Office: + All

(+) Add another search field | (-) Reset search fields | Tooltip Help

641 results

Search

Reset

# Exercise

- How to retrieve more results for the same keywords?



Field Combination

	Front Page	=		?
AND	English Text	=	phone	?
AND	Applicant Name	=	apple	?
AND	Publication Date	=	[2008 TO 2010]	?
AND	English Title	=		?
AND	English Abstract	=		?
AND	Applicant Name	=		?
AND	International Class	=		?
AND	Inventor Name	=		?
AND	Office Code	=		?
AND	English Description	=		?
AND	English Claims	=		?
AND	Inventor Name	Is Empty:	<input checked="" type="radio"/> N/A <input type="radio"/> Yes <input type="radio"/> No	
AND	Licensing availability	=	<input type="checkbox"/>	

Language: English Stem:  Office: + All

(+) Add another search field | (-) Reset search fields  Tooltip Help

**2,068 results**

# Licensing availability

- Launched in 2012
- PCT feature whereby applicants interested in licensing the inventions contained in their international applications can request the International Bureau (IB) to make this information available on its [PATENTSCOPE](#) website.
- Promotion of licensing, including the introduction of a register that encourages applicants to signal their willingness to license their patents

## Field Combination

	Front Page	=		?
AND	WIPO Publication Number	=		?
AND	Application Number	=		?
AND	Publication Date	=		?
AND	English Title	=		?
AND	English Abstract	=		?
AND	Applicant Name	=		?
AND	International Class	=		?
AND	Inventor Name	=		?
AND	Office Code	=		?
AND	English Description	=		?
AND	English Claims	=		?
AND	Inventor Name	Is Empty:	<input checked="" type="radio"/> N/A <input type="radio"/> Yes <input type="radio"/> No	

AND Licensing availability =

Language: English Stem:  Office: + All

(+) Add another search field | (-) Reset search fields [Tooltip Help](#)

Field Combination

	Front Page	=		?
AND	WIPO Publication Number	=		?
AND	Application Number	=		?
AND	Publication Date	=		?
AND	English Title	=		?
AND	English Abstract	=		?
AND	Applicant Name	=		?
AND	International Class	=		?
AND	Inventor Name	=		?
AND	Office Code	=		?
AND	English Description	=		?
AND	English Claims	=		?
AND	Inventor Name	Is Empty:	<input checked="" type="radio"/> N/A <input type="radio"/> Yes <input type="radio"/> No	
AND	Licensing availability		<input checked="" type="checkbox"/>	

Language: English Stem:  Office: + All



(+) Add another search field | (-) Reset search fields  Tooltip Help

1,019 results

Refine Search

+LI:1

Analysis Sort by: View List Length  Side-by-side

Int.Class	Appl.No	Title	Applicant	Ctr	PubDate
1. <a href="#">WO/2018/211516</a>		DERIVATIVES OF TRICYCLIC SPIROLACTONES AND USES THEREOF IN TREATMENT AND MANAGEMENT OF PAIN		WO	22.11.2018
C07D 307/93	 PCT/IL2018/050546		YISSUM RESEARCH DEVELOPMENT COMPANY OF THE HEBREW UNIVERSITY OF JERUSALEM LTD.		TSVELIKHOVSKY, Dmitry
The present application relates to derivatives of tricyclic spirolactones compounds of formula (I) and compositions thereof and uses thereof in treatment and management of pain. Formula (I).					
2. <a href="#">WO/2018/206025</a>		PROJECTILE IN THE FORM OF A HOLLOW TUBE, HAVING INTERNAL ELEVATIONS OR RECESSES OR COMBINATIONS THEREOF, SUCH THAT AIR FLOWING THROUGH SETS THE PROJECTILE IN ROTATION		WO	15.11.2018
F42B 6/02	 PCT/DE2018/000116		BAUMHAUS, Martin		BAUMHAUS, Martin
The invention describes a tubular projectile which is suitable for being fired in particular by bows or crossbows (such as bolts and arrows), but can also be fired from other shooting devices (for example firearms). The arrow is set in rotation about its longitudinal axis by the air passing through after being fired. The rotation is achieved by elevations or recesses applied to the inner surface, which are primarily designed in a linear manner and, by interaction with the air passing through, create a trajectory-stabilizing rotation of the rod or hollow tube. To this end, the arrow generally requires no or less fletching or other elements that stabilize the trajectory.					
3. <a href="#">WO/2018/207178</a>		METHODS OF TREATING PSYCHIATRIC STRESS DISORDERS		WO	15.11.2018
A61K 45/00	 PCT/IL2018/050495		YEDA RESEARCH AND DEVELOPMENT CO. LTD.		FAINZILBER, Michael
Agents and methods of treating a psychiatric stress disorder, Rett syndrome, MeCP2 duplication syndrome or multiple sclerosis are provided. Accordingly there is provided an agent capable of down-regulating activity and/or expression of importin alpha5 for use in the treatment of a medical condition selected from the group consisting of psychiatric stress disorder, Rett syndrome, MeCP2 duplication syndrome and multiple sclerosis. Also provided are methods of identifying an agent that inhibits activity of importin alpha5.					
4. <a href="#">WO/2018/207190</a>		CONCEALED INFORMATION TESTING USING GAZE DYNAMICS		WO	15.11.2018

1. (WO2018211516) DERIVATIVES OF TRICYCLIC SPIROLACTONES AND USES THEREOF IN TREATMENT AND MANAGEMENT OF PAIN

PCT Biblio. Data

Description

Claims

Drawings

National Phase

Notices

Documents

Latest bibliographic data on file with the International Bureau [↻](#) Submit observation

PermaLink [↻](#)

Pub. No.: WO/2018/211516 International Application No.: PCT/IL2018/050546

Publication Date: 22.11.2018 International Filing Date: 17.05.2018

IPC: C07D 307/93 (2006.01), A61K 31/343 (2006.01), C07D 307/94 (2006.01), C07D 307/77 (2006.01), A61P 29/00 (2006.01) [?](#)

Applicants: YISSUM RESEARCH DEVELOPMENT COMPANY OF THE HEBREW UNIVERSITY OF JERUSALEM LTD. [IL/IL]; Hi-Tech Park, Edmond J. Safra Campus Givat Ram P.O.B 39135 9139002 Jerusalem, IL

Inventors: TSVELIKHOVSKY, Dmitry; IL  
PRIEL, Avi; IL

Agent: ERCEGOVIC, Hava; IL

Priority Data: 62/507,394 17.05.2017 US

Title (EN) DERIVATIVES OF TRICYCLIC SPIROLACTONES AND USES THEREOF IN TREATMENT AND MANAGEMENT OF PAIN  
(FR) DÉRIVÉS DE SPIROLACTONES TRICYCLIQUES ET LEURS UTILISATIONS DANS LE TRAITEMENT ET LA GESTION DE LA DOULEUR

Abstract: (EN) The present application relates to derivatives of tricyclic spirolactones compounds of formula (I) and compositions thereof and uses thereof in treatment and management of pain. Formula (I).  
(FR) La présente invention concerne des dérivés de composés spirolactones tricycliques de formule (I) et des compositions de ceux-ci ainsi que leurs utilisations dans le traitement et la gestion de la douleur.

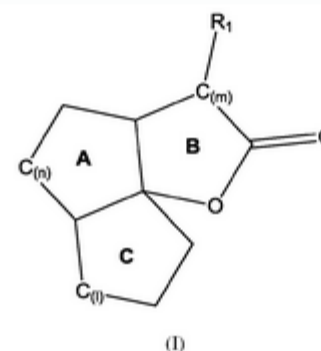

Designated States: AE, AG, AL, AM, AO, AT, AU, AZ, BA, BB, BG, BH, BN, BR, BW, BY, BZ, CA, CH, CL, CN, CO, CR, CU, CZ, DE, DJ, DK, DM, DO, DZ, EC, EE, EG, ES, FI, GB, GD, GE, GH, GM, GT, HN, HR, HU, ID, IL, IN, IR, IS, JO, JP, KE, KG, KH, KN, KP, KR, KW, KZ, LA, LC, LK, LR, LS, LU, LY, MA, MD, ME, MG, MK, MN, MW, MX, MY, MZ, NA, NG, NI, NO, NZ, OM, PA, PE, PG, PH, PL, PT, QA, RO, RS, RU, RW, SA, SC, SD, SE, SG, SK, SL, SM, ST, SV, SY, TH, TJ, TM, TN, TR, TT, TZ, UA, UG, US, UZ, VC, VN, ZA, ZM, ZW  
African Regional Intellectual Property Organization (ARIPO) (BW, GH, GM, KE, LR, LS, MW, MZ, NA, RW, SD, SL, ST, SZ, TZ, UG, ZM, ZW)

Eurasian Patent Office (AM, AZ, BY, KG, KZ, RU, TJ, TM)

European Patent Office (EPO) (AL, AT, BE, BG, CH, CY, CZ, DE, DK, EE, ES, FI, FR, GB, GR, HR, HU, IE, IS, IT, IT, LU, LV, MC, MK,

### Search and Examination-Related Documents

Date	Title	View	Download
22.11.2018	(ISA/210) International Search Report	PDF (8p.)	PDF (8p.), ZIP(XML + TIFFs)
22.11.2018	(ISA/237) Written Opinion of the International Search Authority	PDF (8p.)	PDF (8p.), ZIP(XML + TIFFs)
22.11.2018	Search Strategy	PDF (1p.)	PDF (1p.), ZIP(XML + TIFFs)

### Related Documents on file at the International Bureau

Date	Title	View	Download
22.11.2018	(IB/304) Notification Concerning Submission or Transmittal of Priority Document	PDF (1p.)	PDF (1p.), ZIP(XML + TIFFs)
22.11.2018	Application Body as Filed	PDF (34p.)	PDF (34p.), ZIP(XML + TIFFs)
22.11.2018	(RO/106) Invitation to Correct Defects in the International Application	PDF (2p.)	PDF (2p.), ZIP(XML + TIFFs)
22.11.2018	(IB/301) Notification of receipt of record copy	PDF (1p.)	PDF (1p.), ZIP(XML + TIFFs)
22.11.2018	Applicant Correspondence	PDF (1p.)	PDF (1p.), ZIP(XML + TIFFs)
22.11.2018	Applicant Correspondence	PDF (1p.)	PDF (1p.), ZIP(XML + TIFFs)
22.11.2018	(RO/101) Request form	PDF (5p.)	
22.11.2018	Applicant Correspondence	PDF (1p.)	PDF (1p.), ZIP(XML + TIFFs)
22.11.2018	Applicant Correspondence	PDF (4p.)	PDF (4p.), ZIP(XML + TIFFs)
22.11.2018	(IB/345) Communication in Cases for Which No Other Form is Applicable	PDF (3p.)	PDF (3p.), ZIP(XML + TIFFs)
22.11.2018	(IB/311) Notification Concerning Availability of Publication of the International Application	PDF (1p.)	PDF (1p.), ZIP(XML + TIFFs)
22.11.2018	ePCT Cover Letter	PDF (1p.)	PDF (1p.), ZIP(XML + TIFFs)
22.11.2018	Replacement, Substitute sheets (Rule 26)	PDF (9p.)	PDF (9p.), ZIP(XML + TIFFs)
22.11.2018	Cover Letter	PDF (1p.)	PDF (1p.), ZIP(XML + TIFFs)
22.11.2018	Priority Document	PDF (39p.)	PDF (39p.), ZIP(XML + TIFFs)

### Licensing availability request

Date	Title	View	Download
22.11.2018	(IB/382) Request for indication of availability for licensing purposes	PDF (2p.)	PDF (2p.), ZIP(XML + TIFFs)

REQUEST FOR INDICATION OF AVAILABILITY FOR LICENSING PURPOSES

Applicant's or agent's file reference <b>P-578674-PC</b>	International filing date <i>(day/month/year)</i> <b>17/05/2018</b>
International application No.	Priority date <i>(day/month/year)</i> <b>17/05/2017</b>
Applicant <b>Yissum Research Development Company of The Hebrew University of Jerusalem Ltd.</b>	

1. The applicant hereby requests the International Bureau to **indicate the availability for licensing purposes** of the invention(s) claimed in this international application on the PATENTSCOPE website.

2. Licensing terms *(optional)*: The applicant is willing to license the claimed invention(s):

in:

all PCT Contracting States

all PCT Contracting States except *(indicate each State by its two-letter code)*: \_\_\_\_\_

\_\_\_\_\_

the following State(s) only *(indicate each State by its two-letter code)*: \_\_\_\_\_

\_\_\_\_\_

for **exclusive** use by the licensee                       for **non-exclusive** use by the licensee

3. Additional licensing terms *(optional)* *(if the space below is insufficient, please use the Annex to this form)*:

We are interested in licensing the application in all countries with exclusivity but may negotiate non-exclusive licenses, as well.



# Exercice

- Licensing availability information
- UNIVERSIDADE DE SANTIAGO DE COMPOSTELA

Field Combination

	Front Page	=		?
AND	Applicant Name	=	UNIVERSIDADE DE SANTIAGO DE COMPOSTELA	?
AND	Application Number	=		?
AND	Publication Date	=		?
AND	English Title	=		?
AND	English Abstract	=		?
AND	Applicant Name	=		?
AND	International Class	=		?
AND	Inventor Name	=		?
AND	Office Code	=		?
AND	English Description	=		?
AND	English Claims	=		?
AND	Inventor Name	Is Empty:	<input checked="" type="radio"/> N/A <input type="radio"/> Yes <input type="radio"/> No	
AND	Licensing availability	=	<input checked="" type="checkbox"/>	

Language: English Stem:  Office: + All

(+) Add another search field | (-) Reset search fields [Tooltip Help](#)

5 results

[Search](#)

[Reset](#)

Refine Search PA:( UNIVERSIDADE DE SANTIAGO DE COMPOSTELA) +LI:1

Search

RSS

## Analysis

Countries		IPC		Inventor		Applicant		Pub Date	
Name	No	Name	No	Name	No	Name	No	Date	No
PCT	5	G06F	2	ARES GARCÍA, Jorge	2	UNIVERSIDADE DE SANTIAGO DE COMPOSTELA	5	2011	3
		A61K	1	ARINES PIFERRER, Justo	2	ARES GARCÍA, Jorge	2	2013	1
		C08G	1	CLIMENT JORDÀ, Vicent	2	ARINES PIFERRER, Justo	2	2014	1
		G01J	1	DURÁN BOSCH, Vicente Andrés	2	CLIMENT JORDÀ, Vicent	2		
		G02F	1	LANCIS SÁEZ, Jesús	2	DURÁN BOSCH, Vicente Andrés	2		
				MARTÍNEZ CUENCA, Raúl	2	LANCIS SÁEZ, Jesús	2		
				BARÁ VIÑAS, Salvador X	1	MARTÍNEZ CUENCA, Raúl	2		
				BARÁ VIÑAS, Salvador X.	1				

Sort by: Pub Date Desc

View All

List Length 10

Machine translation

Side-by-side

Int.Class	Title	Applicant	Ctr	PubDate
1. WO/2014/023871	APPARATUS AND METHOD FOR CALCULATING EXPONENTIATION OPERATIONS AND ROOT EXTRACTION	UNIVERSIDADE DE SANTIAGO DE COMPOSTELA	WO	13.02.2014
G06F 17/10	PCT/ES2013/070586	DÍAZ BRUGUERA, Javier		
<p>The invention discloses a method and an apparatus for the general calculation of exponentiation operations. The method is based on the optimization of the calculation <math>Xz = 2Z \log X</math>. The apparatus comprises a plurality of memory elements and a hardware processor configured to calculate the exponentiation operation <math>Xz</math> of a floating-point number <math>X</math>, in which <math>Z</math> is an unrestricted exponent. The unrestricted exponent may be a fixed-point or floating-point number. Furthermore, the exponent may be the reverse of a number, enabling the calculation of roots in the same processor apparatus. The apparatus includes all the elements necessary for calculating <math>Xz</math>.</p>				
2. WO/2013/098451	DYNAMICALLY RECONFIGURABLE HYBRID SIMD/MIMD ARCHITECTURE OF A COPROCESSOR FOR VISION SYSTEMS	UNIVERSIDADE DE SANTIAGO DE COMPOSTELA	WO	04.07.2013
G06F 15/80	PCT/ES2012/070906	BREA SÁNCHEZ, Víctor Manuel		
<p>The present invention relates to a dynamically reconfigurable hybrid Single Instruction, Multiple Data (SIMD) / Multiple Instruction, Multiple Data (MIMD) architecture of a coprocessor used in high-performance systems for computerised vision tasks. The architecture includes a set of processing elements (PE) that receive data via a local area network or a serial-in, parallel-out (SIPO) queue, both managed by a programmable input processor (PIP). The obtained results are sent to the outside via a parallel-in, serial-out (PISO) queue or via the local area network, both elements being managed by the programmable output processor (POP).</p>				
3. WO/2011/110714	METHOD FOR MEASURING OPTICAL ABERRATIONS WITH VARIABLE RANGE AND SENSITIVITY USING TWO RECONFIGURABLE OPTICAL ELEMENTS, AND DEVICE FOR PERFORMING SAME	UNIVERSIDADE DE SANTIAGO DE COMPOSTELA	WO	15.09.2011
G01J 9/00	PCT/ES2011/070151	ARES GARCÍA, Jorge		

The invention relates to a method for measuring optical aberrations with variable range and sensitivity using two reconfigurable optical elements and to a device for performing same. The wavefront (A) to be analysed hits a sampling sub-system (1) that includes a reconfigurable optical element (11) which provides an irradiance pattern (P) that has a controllable position and shape and can be used to measure the aberration. According to the invention, a sub-system (2), which contains another reconfigurable optical element (21), forms an image (I) of the pattern (P) on a fixed plane (3). A detector (4) is disposed on said plane and connected to an analysis sub-system (5) which calculates the aberration (F) of the front (A). A sub-system (6) controls the properties of the reconfigurable elements (11 and 21). Consequently it is not necessary for the detector to be moved mechanically in order to place same in the variable position in which the pattern (P) is formed

# Question

- Where do we find the licensing availability information?

Pub. No.: WO/2014/023871 International Application No.: PCT/ES2013/070586

Publication Date: 13.02.2014 International Filing Date: 08.08.2013

IPC: G06F 17/10 (2006.01) 

Applicants: UNIVERSIDADE DE SANTIAGO DE COMPOSTELA [ES/ES]; Área de Valorización, Transferencia y Emprendimiento Edificio EMPRENDIA - CAMPUS VIDA E-15782 Santiago de Compostela, ES

Inventors: DÍAZ BRUGUERA, Javier; ES  
VÁZQUEZ ÁLVAREZ, Álvaro; ES

Agent: FERNANDO RAFAEL, Pardo Seco; Área de Valorización, Transferencia y Emprendimiento Edificio EMPRENDIA - Campus Vida E-15782 Santiago de Compostela, ES

Priority Data: P201231286 09.08.2012 ES

Title (EN) APPARATUS AND METHOD FOR CALCULATING EXPONENTIATION OPERATIONS AND ROOT EXTRACTION  
(FR) APPAREIL ET PROCÉDÉ POUR CALCULER DES OPÉRATIONS DE POTENTIALISATION ET EXTRATION DE RACINES  
(ES) APARATO Y MÉTODO PARA CALCULAR OPERACIONES DE POTENCIACIÓN Y EXTRACCIÓN DE RAÍCES

Abstract: (EN) The invention discloses a method and an apparatus for the general calculation of exponentiation operations. The method is based on the optimization of the calculation  $X^Z = 2^{Z \times \log X}$ . The apparatus comprises a plurality of memory elements and a hardware processor configured to calculate the exponentiation operation  $X^Z$  of a floating-point number  $X$ , in which  $Z$  is an unrestricted exponent. The unrestricted exponent may be a fixed-point or floating-point number. Furthermore, the exponent may be the reverse of a number, enabling the calculation of roots in the same processor apparatus. The apparatus includes all the elements necessary for calculating  $X^Z$ .

(FR) L'invention concerne un procédé et un appareil permettant le calcul général d'opérations de potentialisation. Le procédé est fondé sur l'optimisation du calcul  $X^Z = 2^{Z \times \log X}$ . L'appareil comprend une pluralité d'éléments de mémoire; et un processeur informatique conçu pour calculer l'opération de potentialisation  $X^Z$  d'un nombre à virgule flottante  $X$ ;  $Z$  étant un exposant sans restrictions. L'exposant sans restrictions peut être un nombre à virgule fixe ou à virgule flottante. En outre, l'exposant peut être inverse d'un nombre ce qui permet de calculer les racines à l'intérieur même du processeur. L'appareil comprend tous les éléments nécessaires pour calculer  $X^Z$ .

(ES) La invención muestra un método y un aparato para el cálculo general de operaciones de potenciación. El método está basado en la optimización del cálculo  $X^Z = 2^{Z \times \log X}$ . El aparato comprende una



Figura 2

AA ... RECIPROCAL  
BB ... SELECTION OF EXPONENTIATION OR QTH ROOT  
CC ... STORAGE  
DD ... HIGH-RADIX LOGARITHM  
EE ... LRCF MULTIPLIER  
FF ... ON-THE-FLY CONVERSION  
GG ... ON-LINE HIGH-RADIX EXPONENTIAL

Related Documents on file at the International Bureau

Date	Title	View	Download
10.02.2015	(IB/373) English Translation of International Preliminary Report on Patentability Chapter I	PDF (6p.)	PDF (6p.), ZIP(XML + TIFFs)
10.02.2015	(IB/326) Notification of Transmittal of Copies of International Preliminary Report on Patentability Chapter I	PDF (1p.)	PDF (1p.), ZIP(XML + TIFFs)
02.12.2014	(IB/308) Notice Informing the Applicant of the Communication of the International Application to the Designated Offices	PDF (1p.)	PDF (1p.), ZIP(XML + TIFFs)
26.03.2014	ePCT Cover Letter	PDF (1p.)	PDF (1p.), ZIP(XML + TIFFs)
04.03.2014	(IB/308) Notice Informing the Applicant of the Communication of the International Application to the Designated Offices	PDF (1p.)	PDF (1p.), ZIP(XML + TIFFs)
13.02.2014	(IB/345) Communication in Cases for Which No Other Form is Applicable	PDF (1p.)	PDF (1p.), ZIP(XML + TIFFs)
13.02.2014	Request to obtain priority document from DAS	PDF (1p.)	PDF (1p.), ZIP(XML + TIFFs)
13.02.2014	(ISA/202) Notification of Receipt of Search Copy	PDF (1p.)	PDF (1p.), ZIP(XML + TIFFs)
13.02.2014	(RO/101) Request form	PDF (5p.)	
13.02.2014	(IB/304) Notification Concerning Submission or Transmittal of Priority Document	PDF (1p.)	PDF (1p.), ZIP(XML + TIFFs)
13.02.2014	(IB/301) Notification of receipt of record copy	PDF (1p.)	PDF (1p.), ZIP(XML + TIFFs)
13.02.2014	ex-officio corrections	PDF (7p.)	PDF (7p.), ZIP(XML + TIFFs)
13.02.2014	(IB/311) Notification Concerning Availability of Publication of the International Application	PDF (1p.)	PDF (1p.), ZIP(XML + TIFFs)
13.02.2014	Validation Log	PDF (1p.)	PDF (1p.), ZIP(XML + TIFFs)
13.02.2014	Communication with PCT Authority	TXT	TXT , ZIP(XML + TIFFs)
13.02.2014	Priority Document	PDF (25p.)	PDF (25p.), ZIP(XML + TIFFs)
13.02.2014	Application Body as Filed	PDF (26p.)	PDF (26p.), ZIP(XML + TIFFs)

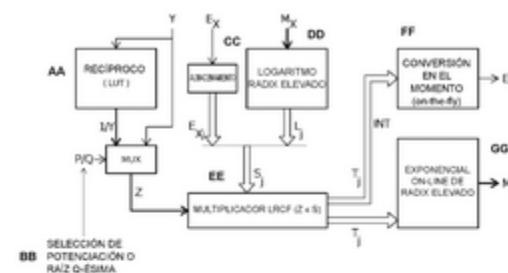
Licensing availability request

Date	Title	View	Download
26.03.2014	Request for indication of availability for licensing purposes	PDF (1p.)	PDF (1p.), ZIP(XML + TIFFs)

# Field Combination - pros

- Predefined fields
- Immediate results on the same page

A screenshot of a search field dropdown menu. The menu is open, showing a list of predefined search fields. The 'English Text' option is highlighted in yellow. Other visible options include 'Front Page', 'English Abstract', 'English All', 'English Claims', 'English Description', 'English Title', 'Exact IPC code', 'Filing Language', 'Front Page(FP)', 'English Description', 'English Claims', and 'Inventor Name'.

A screenshot of a search results page. The search query is displayed as follows:

AND	English Abstract	=		?
AND	Applicant Name	=		?
AND	International Class	=		?
AND	Inventor Name	=		?
AND	Office Code	=		?
AND	English Description	=		?
AND	English Claims	=		?
AND	Inventor Name	Is Empty:	<input checked="" type="radio"/> N/A <input type="radio"/> Yes <input type="radio"/> No	
AND	Licensing availability	=	<input type="checkbox"/>	

Language: English Stem:  Office: + All

(+) Add another search field | (-) Reset search fields | Tooltip Help

5 2 **2,068 results** Search Reset

# Field combination - cons

Field Combination

Front Page	▼	ORmobile AND smart AND intelligent AND technology AND voice AND recognitor	?		
AND	▼	English Text	=		?
AND		Applicant Name	=		?
OR		Publication Date	=		?
AND	▼	English Title	=		?
AND	▼	English Abstract	=		?
AND	▼	Applicant Name	=		?



Advanced Search

Search For:

FP:(EN\_TI:(“vessel” OR “container”) OR EN\_AB:(“vessel” OR “container”)) OR (DA\_TI:(“beholder” OR “fartøj” OR “dekontaminering” OR “skib” OR “fartoej” OR “baandhus” OR “kar” OR “staaende” OR “kammer”) OR DA\_AB:(“beholder” OR “fartøj” OR “dekontaminering” OR “skib” OR “fartoej” OR “baandhus” OR “kar” OR “staaende” OR “kammer”)) OR (DE\_TI:(“Behälter” OR “Schiff” OR “Gefässes” OR “Blutgefässen” OR “Container” OR “hervorhebung” OR “vaskuläre” OR “Gefässbewegung” OR “Gefäßes”) OR DE\_AB:(“Behälter” OR “Schiff” OR “Gefässes” OR “Blutgefässen” OR “Container” OR “hervorhebung” OR “vaskuläre” OR “Gefässbewegung” OR “Gefäßes”)) OR (ES\_TI:(“recipiente” OR “buques” OR “envase” OR “depósito” OR “contenedor” OR “vaso” OR “barco” OR “embarcación”) OR ES\_AB:(“recipiente” OR “buques” OR “envase” OR “depósito” OR “contenedor” OR “vaso” OR “barco” OR “embarcación”)) OR (FR\_TI:(“récipient” OR “vaisseau” OR “conteneur” OR “cuve” OR “navire” OR “ustensile” OR “vasculaire”) OR FR\_AB:(“récipient” OR “vaisseau” OR “conteneur” OR “cuve” OR “navire” OR “ustensile” OR “vasculaire”)) OR (IT\_TI:(“contenitore” OR “vaso” OR “recipiente” OR “natante” OR “serbatoio”) OR IT\_AB:(“contenitore” OR “vaso” OR “recipiente” OR “natante” OR “serbatoio”)) OR (JA\_TI:(“容器” OR “コンテナ” OR “船舶” OR “導管” OR “槽”) OR JA\_AB:(“容器” OR “コンテナ” OR “船舶” OR “導管” OR “槽”)) OR (KO\_TI:(“용기” OR “컨테이너” OR “선박” OR “압력용기용” OR “그릇” OR “선석” OR “베슬”) OR KO\_AB:(“용기” OR “컨테이너” OR “선박” OR “압력용기용” OR “그릇” OR “선석” OR “베슬”)) OR (NL\_TI:(“houder” OR “vat” OR “vaartuig” OR “bloedvat” OR “container” OR “magazijn” OR “schip” OR “reservoir” OR “drukvat”) OR NL\_AB:(“houder” OR “vat” OR “vaartuig” OR “bloedvat” OR “container” OR “magazijn” OR “schip” OR “reservoir” OR “drukvat”)) OR (PL\_TI:(“pojemnik” OR “kontenerem” OR “zbiornika” OR “naczyniu” OR “ciśnieniowego”) OR PL\_AB:(“pojemnik” OR “kontenerem” OR “zbiornika” OR “naczyniu” OR “ciśnieniowego”)) OR (PT\_TI:(“recipiente” OR “equipamento de processo” OR “vaso” OR “contêiner” OR “contentor” OR “navio” OR “recinto” OR “embarcação”) OR PT\_AB:(“recipiente” OR “equipamento de processo” OR “vaso” OR “contêiner” OR “contentor” OR “navio” OR “recinto” OR “embarcação”)) OR (RU\_TI:(“контейнер” OR “емкости” OR “судна” OR “сосуде” OR “контейнерном” OR “судов” OR “инертных газов судах” OR “инертных газов на судах” OR “резервуар”) OR RU\_AB:(“контейнер” OR “емкости” OR “судна” OR “сосуде” OR “контейнерном” OR “судов” OR “инертных газов судах” OR “инертных газов на судах” OR “резервуар”)) OR (SV\_TI:(“behållare” OR “svengningar” OR “käril” OR “fartyg” OR “farkost” OR “detektion” OR “flytkropp” OR “box” OR “kerl”) OR SV\_AB:(“behållare” OR “svengningar” OR “käril” OR “fartyg” OR “farkost” OR “detektion” OR “flytkropp” OR “box” OR “kerl”)) OR (ZH\_TI:(“容器” OR “集装箱” OR “血管” OR “船舶” OR “器皿” OR “艇” OR “脉管”) OR ZH\_AB:(“容器” OR “集装箱” OR “血管” OR “船舶” OR “器皿” OR “艇” OR “脉管”))



Expand with related terms ↓

Language: English Stem:  Office: + All

# Searches

The screenshot displays the top navigation bar of the WIPO search portal. The navigation menu includes 'Search', 'Browse', 'Translate', and 'News'. On the right side of the navigation bar, there are icons for user profile, settings, and help. A dropdown menu is open over the 'Search' button, listing the following options: 'Simple', 'Advanced Search' (which is highlighted), 'Field Combination', 'Cross Lingual Expansion', and 'Chemical compounds (login required)'. Below the navigation bar, a search input field is visible with a question mark icon and the text 'Office:All'. To the right of the input field is a 'Search' button. A snippet of a search result is visible below the search bar, mentioning '2 million patent documents including 3.5 million published international patent applications (PCT). Detailed coverage'. At the bottom of the page, the WIPO logo and full name are displayed.

Q Search | Browse | Translate | News

Simple

Advanced Search

Field Combination

Cross Lingual Expansion

Chemical compounds (login required)

Office:All Search

2 million patent documents including 3.5 million published international patent applications (PCT). Detailed coverage

PCT Publication 45/2040 (00 44 2040) is now available. The next publication date is scheduled as follows: Class number 40/2040 (45 44 2040) ...

**WIPO**  
WORLD  
INTELLECTUAL PROPERTY  
ORGANIZATION

Advanced Search



Search For:

FP:(EN\_TI:(“vessel” OR “container”) OR EN\_AB:(“vessel” OR “container”)) OR (DA\_TI:(“beholder” OR “fartøj” OR “dekontaminering” OR “skib” OR “fartoej” OR “baandhus” OR “kar” OR “staaende” OR “kammer”) OR DA\_AB:(“beholder” OR “fartøj” OR “dekontaminering” OR “skib” OR “fartoej” OR “baandhus” OR “kar” OR “staaende” OR “kammer”)) OR (DE\_TI:(“Behälter” OR “Schiff” OR “Gefässes” OR “Blutgefässen” OR “Container” OR “hervorhebung” OR “vaskuläre” OR “Gefässbewegung” OR “Gefäßes”) OR DE\_AB:(“Behälter” OR “Schiff” OR “Gefässes” OR “Blutgefässen” OR “Container” OR “hervorhebung” OR “vaskuläre” OR “Gefässbewegung” OR “Gefäßes”)) OR (ES\_TI:(“recipiente” OR “buques” OR “envase” OR “depósito” OR “contenedor” OR “vaso” OR “barco” OR “embarcación”) OR ES\_AB:(“recipiente” OR “buques” OR “envase” OR “depósito” OR “contenedor” OR “vaso” OR “barco” OR “embarcación”)) OR (FR\_TI:(“réipient” OR “vaisseau” OR “conteneur” OR “cuve” OR “navire” OR “ustensile” OR “vasculaire”) OR FR\_AB:(“réipient” OR “vaisseau” OR “conteneur” OR “cuve” OR “navire” OR “ustensile” OR “vasculaire”)) OR (IT\_TI:(“contenitore” OR “vaso” OR “recipiente” OR “natante” OR “serbatoio”) OR IT\_AB:(“contenitore” OR “vaso” OR “recipiente” OR “natante” OR “serbatoio”)) OR (JA\_TI:(“容器” OR “コンテナ” OR “船舶” OR “導管” OR “槽”) OR JA\_AB:(“容器” OR “コンテナ” OR “船舶” OR “導管” OR “槽”)) OR (KO\_TI:(“용기” OR “컨테이너” OR “선박” OR “압력용기용” OR “그릇” OR “선석” OR “베슬”) OR KO\_AB:(“용기” OR “컨테이너” OR “선박” OR “압력용기용” OR “그릇” OR “선석” OR “베슬”)) OR (NL\_TI:(“houder” OR “vat” OR “vaartuig” OR “bloedvat” OR “container” OR “magazijn” OR “schip” OR “reservoir” OR “drukvat”) OR NL\_AB:(“houder” OR “vat” OR “vaartuig” OR “bloedvat” OR “container” OR “magazijn” OR “schip” OR “reservoir” OR “drukvat”)) OR (PL\_TI:(“pojemnik” OR “kontenerem” OR “zbiornika” OR “naczyniu” OR “ciśnieniowego”) OR PL\_AB:(“pojemnik” OR “kontenerem” OR “zbiornika” OR “naczyniu” OR “ciśnieniowego”)) OR (PT\_TI:(“recipiente” OR “equipamento de processo” OR “vaso” OR “contêiner” OR “contentor” OR “navio” OR “recinto” OR “embarcação”) OR PT\_AB:(“recipiente” OR “equipamento de processo” OR “vaso” OR “contêiner” OR “contentor” OR “navio” OR “recinto” OR “embarcação”)) OR (RU\_TI:(“контейнер” OR “емкости” OR “судна” OR “сосуде” OR “контейнерном” OR “судов” OR “инертных газов судах” OR “инертных газов на судах” OR “резервуар”) OR RU\_AB:(“контейнер” OR “емкости” OR “судна” OR “сосуде” OR “контейнерном” OR “судов” OR “инертных газов судах” OR “инертных газов на судах” OR “резервуар”)) OR (SV\_TI:(“behållare” OR “svengningar” OR “käril” OR “fartyg” OR “farkost” OR “detektion” OR “flytkropp” OR “box” OR “kerl”) OR SV\_AB:(“behållare” OR “svengningar” OR “käril” OR “fartyg” OR “farkost” OR “detektion” OR “flytkropp” OR “box” OR “kerl”)) OR (ZH\_TI:(“容器” OR “集装箱” OR “血管” OR “船舶” OR “器皿” OR “艇” OR “脉管”) OR ZH\_AB:(“容器” OR “集装箱” OR “血管” OR “船舶” OR “器皿” OR “艇” OR “脉管”))



Expand with related terms ↓

Language: English Stem:  Office: + All



Search For:

FP:(**(EN\_Ti:("vessel" OR "container") OR EN\_AB:("vessel" OR "container")) OR (DA\_Ti:("beholder" OR "fartøj" OR "dekontaminering" OR "skib" OR "fartoej" OR "baandhus" OR "kar" OR "staaende" OR "kammer") OR DA\_AB:("beholder" OR "fartøj" OR "dekontaminering" OR "skib" OR "fartoej" OR "baandhus" OR "kar" OR "staaende" OR "kammer")) OR (DE\_Ti:("Behälter" OR "Schiff" OR "Gefässes" OR "Blutgefässen" OR "Container" OR "hervorhebung" OR "vaskuläre" OR "Gefässbewegung" OR "Gefäßes") OR DE\_AB:("Behälter" OR "Schiff" OR "Gefässes" OR "Blutgefässen" OR "Container" OR "hervorhebung" OR "vaskuläre" OR "Gefässbewegung" OR "Gefäßes")) OR (ES\_Ti:("recipiente" OR "buques" OR "envase" OR "depósito" OR "contenedor" OR "vaso" OR "barco" OR "embarcación") OR ES\_AB:("recipiente" OR "buques" OR "envase" OR "depósito" OR "contenedor" OR "vaso" OR "barco" OR "embarcación")) OR (FR\_Ti:("récipient" OR "vaisseau" OR "conteneur" OR "cuve" OR "navire" OR "ustensile" OR "vasculaire") OR FR\_AB:("récipient" OR "vaisseau" OR "conteneur" OR "cuve" OR "navire" OR "ustensile" OR "vasculaire")) OR (IT\_Ti:("contenitore" OR "vaso" OR "recipiente" OR "natante" OR "serbatoio") OR IT\_AB:("contenitore" OR "vaso" OR "recipiente" OR "natante" OR "serbatoio")) OR (JA\_Ti:("容器" OR "コンテナ" OR "船舶" OR "導管" OR "槽") OR JA\_AB:("容器" OR "コンテナ" OR "船舶" OR "導管" OR "槽")) OR (KO\_Ti:("용기" OR "컨테이너" OR "선박" OR "압력용기용" OR "그릇" OR "선석" OR "베슬") OR KO\_AB:("용기" OR "컨테이너" OR "선박" OR "압력용기용" OR "그릇" OR "선석" OR "베슬")) OR (NL\_Ti:("houder" OR "vat" OR "vaartuig" OR "bloedvat" OR "container" OR "magazijn" OR "schip" OR "reservoir" OR "drukvat") OR NL\_AB:("houder" OR "vat" OR "vaartuig" OR "bloedvat" OR "container" OR "magazijn" OR "schip" OR "reservoir" OR "drukvat")) OR (PL\_Ti:("pojemnik" OR "kontenerem" OR "zbiornika" OR "naczyniu" OR "ciśnieniowego") OR PL\_AB:("pojemnik" OR "kontenerem" OR "zbiornika" OR "naczyniu" OR "ciśnieniowego")) OR (PT\_Ti:("recipiente" OR "equipamento de processo" OR "vaso" OR "contêiner" OR "contentor" OR "navio" OR "recinto" OR "embarcação") OR PT\_AB:("recipiente" OR "equipamento de processo" OR "vaso" OR "contêiner" OR "contentor" OR "navio" OR "recinto" OR "embarcação")) OR (RU\_Ti:("контейнер" OR "емкости" OR "судна" OR "сосуде" OR "контейнерном" OR "судов" OR "инертных газов судах" OR "инертных газов на судах" OR "резервуар") OR RU\_AB:("контейнер" OR "емкости" OR "судна" OR "сосуде" OR "контейнерном" OR "судов" OR "инертных газов судах" OR "инертных газов на судах" OR "резервуар")) OR (SV\_Ti:("behållare" OR "svengningar" OR "kärl" OR "fartyg" OR "farkost" OR "detektion" OR "flytkropp" OR "box" OR "kerl") OR SV\_AB:("behållare" OR "svengningar" OR "kärl" OR "fartyg" OR "farkost" OR "detektion" OR "flytkropp" OR "box" OR "kerl")) OR (ZH\_Ti:("容器" OR "集装箱" OR "血管" OR "船舶" OR "器皿" OR "艇" OR "脉管") OR ZH\_AB:("容器" OR "集装箱" OR "血管" OR "船舶" OR "器皿" OR "艇" OR "脉管"))**



Expand with related terms

Language:  Stem:  Office:  AllInstant Help  Tooltip Help 

Search

Reset

## Advanced Search

Search For:  "electric car" ?

[Expand with related terms](#) ↓

Language:  Stem:  Office:  All

Instant Help  Tooltip Help

## Advanced Search

Search For:  ?

[Hide the expanded query](#) ↑

Expanded query:  ↻

Language:  Stem:  Office:  All

Instant Help  Tooltip Help

# How to build your queries

Advanced Search

Search For:  ?

Expand with related terms ↓

Language:  Stem:  Office:  All

Instant Help  Tooltip Help

- EN\_ALLTXT; PA; DP = fields
- AND = operator

# Fields: where to search

Source: <http://spicewallpaper.blogspot.ch/2012/08/green-fields-with-blue-sky.html>



# National Collections - Fields Definition

English

French

German

Spanish

Japanese

Russian

Vietnamese

Fields Diagram

Symbol	Name	Help	Type	Stemmed	Parent
ALLNAMES	All Names	<ul style="list-style-type: none"> <li>将在发明人、申请人和代理人的姓名或名称中检索输入的值。</li> <li>◀Smith OR Klein</li> </ul>	text		[FP, ALL]
ALLNUM	All Numbers and IDs	<ul style="list-style-type: none"> <li>The entered value is searched against the application number, the WO publication number, the national publication number and the priority number.</li> <li>◀98/12*,98/12, 1998/12*, 1998/000012</li> <li>◀US200500*</li> <li>◀23412 CU</li> <li>◀2007 8603 MX</li> </ul>	string		[FP, *_FP, ALL, *_ALL]
AAD	Applicant Address	<ul style="list-style-type: none"> <li>The entered value is searched against the address of the applicant. It can be the street or the city/town</li> <li>◀Berlin</li> </ul>	text		[PAA]
AADC	Applicant Address Country	<ul style="list-style-type: none"> <li>The entered value is searched against the country of the applicant. To be used with the 2 letter country code</li> <li>◀US</li> </ul>	string		[PAA]
PAA	Applicant All Data	<ul style="list-style-type: none"> <li>The entered value is searched against all the data of the applicant</li> <li>◀john US California</li> </ul>	text		[ALL]
PA	Applicant Name	<ul style="list-style-type: none"> <li>The entered value is searched against the applicant name</li> <li>◀john</li> </ul>	text		[PAA, ALLNAMES]
ANA	Applicant Nationality	<ul style="list-style-type: none"> <li>The entered value is searched against the nationality of the applicant. To be used with the 2 letter country code</li> <li>◀US</li> </ul>	string		[PAA]
ARE	Applicant Residence	<ul style="list-style-type: none"> <li>The entered value is searched against the residence of the applicant. To be used with the 2 letter country code</li> <li>◀US</li> </ul>	string		[PAA]
AD	Application Date	<ul style="list-style-type: none"> <li>The entered value is searched against the application date</li> <li>◀[01.01.2000 TO 01.01.2005]</li> </ul>	date		[ALL]
AN	Application Number	<ul style="list-style-type: none"> <li>The entered value is searched against the application number</li> </ul>	string		[ALLNUM]



# Examples

- FP = front page
- ALL = all fields
- ALL\_NAMES = all names
- IC = IPC
- DP = publication date
- CTR = country either WO or country from nat collection
- NPCC= national phase entry
- AN = origin of PCT

# Date search

- Simple:
  - DP:01.02.2000
  - DP:20000201
  - DP:02.2000
  - DP:200002
  - DP:2000

# Example: IPC

- IC = International Classification
  - IC :A
  - IC :A47
  - IC :A47L
  - IC :A47L1
  - IC:A47L11
  - IC:A47L11/03

- **D06F 1/06** will include by default
  - D06F 1/08**
  - 1/10**
  - 1/16**

To exclude subgroup: IC\_EX

- ICI = International Classification Inventive
- ICN = International Classification Non-inventive
- ICI\_EX ICN\_EX = no subgroup

# Example: grant

1. (IN201741018339) A SUSPENSION ENERGY RECOVERY SYSTEM (SERS) AND A METHOD THEREOF

National Biblio. Data

Documents

PermaLink 

**Application Number:** 201741018339 **Application Date:** 25.05.2017

**Publication Number:** 201741018339 **Publication Date:** 30.03.2018

**Grant Number:** 301729 **Grant Date:** 01.10.2018

**Publication Kind :** B

**IPC:** F03G 7/08 

**Applicants:** Magveh Energy Recovery Systems Private Limited

**Inventors:** Aditya M. Deshpande  
Aman K. Saha  
Rahul Kumar  
Saroja V. Siddamal  
Vivek Kumar

**Priority Data:**

**Title:** (EN) A SUSPENSION ENERGY RECOVERY SYSTEM (SERS) AND A METHOD THEREOF

**Abstract:** (EN) An energy recovery system 100 in a suspension system of an automobile, the energy recovery system comprising an energy recovery unit 101 coupled with a shock absorber 102. The energy recovery unit 101 further comprising a direction control valve 103, a control mechanism 105, a linear generator 106 and a power electronics unit 107 wherein the system is enabled to convert the linear motion obtained in the shock absorber to a reciprocating motion in the double acting cylinder using the direction control valve wherein the reciprocating motion enables the piston rod having the linear magnetic array to reciprocate in the linear stator to produce electrical energy which is stored in the electrical storage unit 108 via the power electronics unit 107.

# PCT related Fields

## ■ ISA

ST.3 Office code of the patent authority that performed the preliminary search report

ISA:US and OF:WO

## ■ ISR

For an ISR document in status filed (ISR): Report ; if there is an Article 17(2)(a) declaration in status filed (A172A): Declaration

ISR:declaration and OF:WO

## ■ SIS

If any Supplementary International Search Report has been received, show status “report”; If no SIS Reports or Declarations are on file, show status “None” SIS:report and OF:WO

## ■ IPE

If there is an IPER in status filed (IPER or IPRP2) and the time limit for making the report visible i PATENTSCOPE has passed: Report

IPE:report and OF:WO

# Fields rules

- Basic fields: elements of a patent document
- Derived fields

- 2 letter code = individual field

EN\_TI            FR\_AB            ES\_DE\_S

Convention: language specified by 2 letters  
                  if not specified all languages

S = stemmed

- : to separate term without any space

# Intuitive queries

- PCTHavingThirdPartyObservations
- PCTPublishedLastWeek
- PCTHavingApplicantFromUS
- DP>Last1Year
- DP:[Today-1Week TO Today]



## International Application Status

Date	Title	View	Download
23.10.2018	International Application Status Report	HTML, PDF, XML	PDF, XML

## Published International Application

Date	Title	View	Download
16.08.2018	Initial Publication with ISR( (A1 33/2018))	PDF (49p.)	PDF (49p.), ZIP(XML + TIFFs)

## Search and Examination-Related Documents

Date	Title	View	Download
12.09.2018	Additional comments submitted with observation	PDF (10p.)	PDF (10p.), ZIP(XML + TIFFs)
12.09.2018	Third Party Observation	PDF (6p.)	PDF (6p.), ZIP(XML + TIFFs)
16.08.2018	(ISA/237) Written Opinion of the International Search Authority	PDF (5p.)	PDF (5p.), ZIP(XML + TIFFs)
16.08.2018	(ISA/210) International Search Report	PDF (4p.)	PDF (4p.), ZIP(XML + TIFFs)

## Related Documents on file at the International Bureau

Date	Title	View	Download
04.09.2018	(IB/308) Notice Informing the Applicant of the Communication of the International Application to the Designated Offices	PDF (1p.)	PDF (1p.), ZIP(XML + TIFFs)
16.08.2018	(IB/311) Notification Concerning Availability of Publication of the International Application	PDF (1p.)	PDF (1p.), ZIP(XML + TIFFs)
16.08.2018	(IB/304) Notification Concerning Submission or Transmittal of Priority Document	PDF (1p.)	PDF (1p.), ZIP(XML + TIFFs)
16.08.2018	(ISA/202) Notification of Receipt of Search Copy	PDF (1p.)	PDF (1p.), ZIP(XML + TIFFs)
16.08.2018	(RO/101) Request form	PDF (5p.)	PDF (5p.), ZIP(XML + TIFFs)
16.08.2018	Application Body as Filed	PDF (45p.)	PDF (45p.), ZIP(XML + TIFFs)
16.08.2018	(RO/106) Invitation to Correct Defects in the International Application	PDF (4p.)	PDF (4p.), ZIP(XML + TIFFs)
16.08.2018	(RO/105) Notification of the International Application Number and of the	PDF (1p.)	PDF (1p.), ZIP(XML + TIFFs)

# Fields: golden rules

- EN\_ALL = default field → field indicator not required
- Field name followed by : ":" or "/"
- The field is only valid for the term that it directly precedes, so the query:

```
EN_TI:("wind turbine" AND electric) solar
```

- **"wind turbine" AND electric** in the title field  
**"solar"** in the default field (EN\_ALL ).

# Grouping- nesting



# Grouping/nesting

- Solar OR (wind AND turbine)
- (solar OR wind) AND turbine
  
- EN\_TI: electric car  
electric will be searched in English title but car in all fields
  
- EN\_TI: (electric car)  
Both electric and car will be searched in the English title

# Range search

- Range:

- DP:[01.01.2000 TO 01.01.2001]

- Can also be used to search non-date fields

- IN: {Smith to Terence}

# How to build your queries

Advanced Search

Search For:  ?

Expand with related terms ↓

Language:  Stem:  Office:  All

Instant Help  Tooltip Help

- EN\_ALLTXT; PA; DP = fields
- AND = operator

# Boolean operators

- AND
- OR
- NOT
- ANDNOT

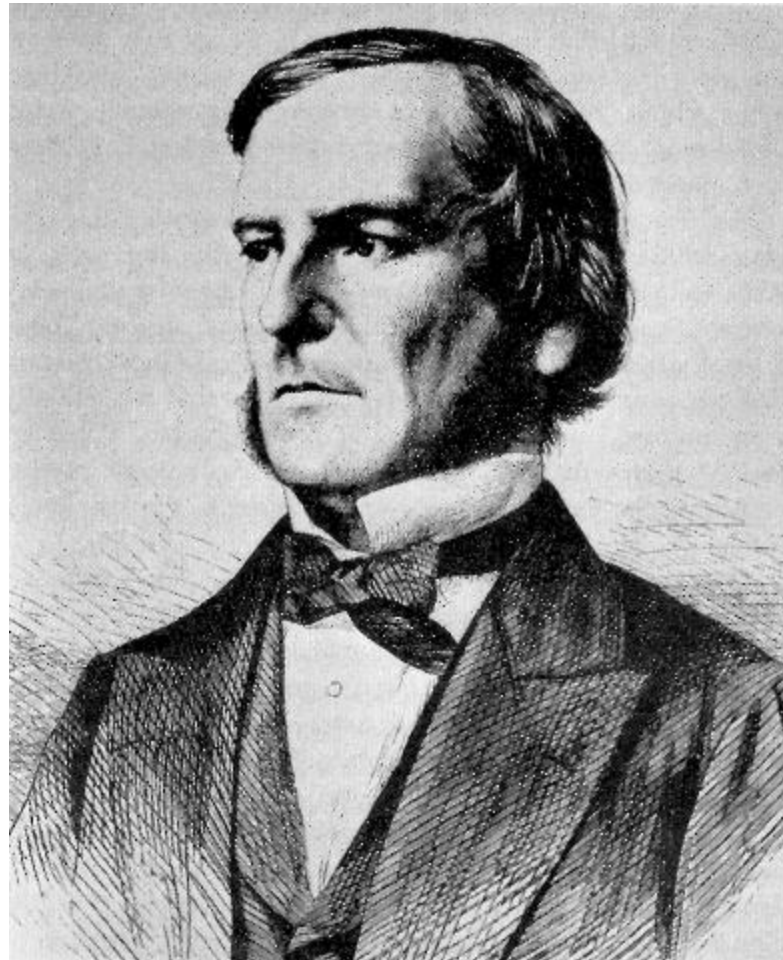

# ANDNOT - NOT

- Use ANDNOT when searching A excluding B  
Ex: bicycle ANDNOT boat
- Use NOT when searching all documents except A  
Ex:NOT(car AND bicycle AND boat)



# Proximity operator NEAR

- Finds words that are next to each other
- NEAR3 → 3 = the max nb of word gaps between 2 search terms

Title		Ctr	PubDate
Int.Class	Appl.No	Applicant	Inventor
1. 1020080111935 ELECTRIC BICYCLE REMOTE CONTROL CONTROLLING SYSTEM FOR QUICKLY OPERATING THE REMOTE CONTROLLER		KR	24.12.2008
H04Q 9/04	1020070060503	KIM, SOON PIL	KIM, SOON PIL
PURPOSE: An electric bicycle remote control controlling system is provided to start moving the electric bicycle quickly and to start operating the electric bicycle through a remote controller by applying a vehicle remote controller system. CONSTITUTION: An electric bicycle remote control controlling system includes an electric bicycle battery and a remote controller. The electric bicycle battery includes a starting connection part and a remote recognition sensor. The remote controller controls the battery of electric bicycle to control the electric bicycle. ©KIPO 2009			
2. WO/2018/084358 THEFT PREVENTION SYSTEM FOR ELECTRIC BICYCLE BATTERY		WO	11.05.2018
B62H 5/00	PCT/KR2016/013804	LKWAY CO., LTD.	HYUN, Hong Jun
The present invention relates to a theft prevention system for an electric bicycle battery. A location information transmitting means is provided on an electric bicycle battery and the location information of the electric bicycle battery is transmitted to a control server. The control server has a smart terminal of a user registered with respect to the respective electric bicycle battery and transmits information relating to the location of the electric bicycle battery to the registered smart terminal. Accordingly, a user of the respective electric bicycle can locate the electric bicycle battery by means of the smart device, and thus the electric bicycle battery can be prevented from being stolen.			
3. 101486322 Parameter setting system and method of electric bicycle controller		CN	22.07.2009
B60L 15/00	200910067702.0	Tianjin Santroll Electric Science & Technology Co., Ltd.	Kong Zhaosong
The invention relates to a parameter setting system and a method for an electric bicycle controller. The parameter setting system for the electric bicycle controller comprises the electric bicycle controller in which a memory is arranged, and a communication port of the electric bicycle controller is connected with a communication port of a parameter setting terminal of the electric bicycle controller. The method comprises that: by establishing a communication mode between the electric bicycle controller and the parameter setting terminal of the electric bicycle controller, the parameter setting terminal of the electric bicycle controller sends a control parameter table to the electric bicycle controller, and the electric bicycle controller stores the received control parameter table into a memory inside the electric bicycle controller. Through once operation, the system and the method can finish total parameter setting of the electric bicycle controller, have the characteristics of simple operation and convenient use, and are convenient for electric bicycle factories to design, produce, maintain and manage.			
4. 101486318 Real time monitoring system and method for electric bicycle		CN	22.07.2009
B60L 1/00	200910067703.5	Tianjin Santroll Electric Science & Technology Co., Ltd.	Kong Zhaosong
The invention relates to a real-time monitoring system and a method for an electric bicycle. The real-time monitoring system for the electric bicycle consists of an electric bicycle controller, a turning handle, a brake lever, an electric motor and a battery which are connected, wherein a communication port of the electric bicycle controller is connected with a communication port of an electric bicycle monitoring terminal. A real-time monitoring mode comprises that: by establishing a communication mode between the electric bicycle controller and the electric bicycle monitoring terminal, the electric bicycle controller reads equipment state data, and the electric bicycle monitoring terminal receives the equipment state data and statistically analyzes and displays the equipment state data so as to achieve real-time monitoring function of the running state of the electric bicycle. The real-time monitoring system and the method facilitate electric bicycle factories, electric bicycle controller factories and electric bicycle dealers to use, and improve design, production and service levels.			
5. 2003068545 ELECTROMAGNETIC INDUCTION TYPE CONNECTOR		JP	07.03.2003
H01E 28/14	2001254702	SUMITOMO WIRING SYST LTD	WATANABE KUNIHICO

# Proximity search: BEFORE

- the order of terms is significant.

**keywordA BEFORE keywordB**

# An example



Search For: EN\_AB: (snow AND shoe) ?

[Expand with related terms](#) ↓Language: English ▾ Stem:  Office: + AllInstant Help  Tooltip Help 

Search

Reset

8. [2000342302](#) ANTISLIPPING SHOE SOLE MATERIAL FOR WINTER SEASON

JP

12.12.2000

A43B 13/22



19486399

SAKURADA KICHIZO

SAKURADA KICHIZO

PROBLEM TO BE SOLVED: To ensure comfortable walking on a **snow** pressed and frozen road surface by using an uneven, thick **shoe** sole material of independent softer foamed sponge than a general **shoe** sole material.

SOLUTION: It is noted that **snow** frozen water is originally affinitive with each other in consideration of the movement of a **shoe** sole in frozen season arising at the **shoe** sole in walking and the operating mechanism of frozen water. Accordingly, a **shoe** sole 7 employs a greatly uneven soft sponge superior in heat insulation, retaining softness even in cold season. **Snow** frozen water deposited on the **shoe** sole is thus fastened to a frozen road surface 4 and the soft **shoe** sole surface is deformed to cause the separation of the **snow** frozen water deposited to the **shoe** sole 7 to be fastened to the road surface and the close contact of the soft sponge **shoe** sole with the instantaneously formed frozen road surface, so that the **shoe** sole can physically and configurationally grip the frozen road surface to permit walking on the frozen road surface.

COPYRIGHT: (C)2000,JPO

9. [WO/1989/008480](#) SNOW GLIDER

WO

21.09.1989

A63C 10/08



PCT/CH1989/000051

AITEC AG

VORSTEHER, Bettina

A **snow** glider is provided with at least one fastening element (2) by means of which the user's **shoe** can be fastened to the **snow** glider. The fastening element (2) comprises a base (10) which can be rotatably mounted on the **snow** glider base (1) and fixed in the set position by means of a catch mechanism (30). The **snow** glider is also provided with a brake (50) which can be actuated via a pivoting plate (57) by the **shoe** retained in the fastening device (2). The angle between the fastening device and the base can be adjusted without having to remove the **shoe** from the fastening device.

10. [1020150088386](#) SHOES WITH WIPER

KR

03.08.2015

A43B 7/00





1020140008639

이준규

LEE, JUN KUELEE, JUN KUE

The present invention relates to **shoes** with a wiper, which is provided to remove **snow** from **shoes** before an indoor space gets dirty due to the **snow** while the **snow** on the **shoes** is melting when a wearer enters the indoor space after walking on a snowy road in winter. COPYRIGHT KIPO 2015



Advanced Search 

Search For:  

[Expand with related terms ↓](#)

Language:  Stem:  Office:  All

Instant Help  Tooltip Help

Int.Class	Appl.No	Title	Applicant	Ctr	PubDate
1. 103535980		<b>Air-inflation snow shoe</b>		CN	29.01.2014
A43B 5/04	 201310539482.3		Wang Lizhu		Wang Lizhu
<p>The invention discloses an air-inflation <b>snow shoe</b>. The air-inflation <b>snow shoe</b> consists of a <b>snow shoe</b> body, an air bag, a fixing frame and an opening assembly, wherein the air bag is arranged on a shoe sole of the <b>snow shoe</b> body, the fixing frame wraps the air bag under the shoe sole of the <b>snow shoe</b> body, and the opening assembly is arranged on the side face of the <b>snow shoe</b> body and connected with the air bag. The air bag at the bottom of the <b>snow shoe</b> can be opened and expand by opening the opening assembly when a user wearing the <b>snow shoe</b> needs to walk in a snowfield, and accordingly the user wearing the air-inflation <b>snow shoe</b> can conveniently walk in the snowfield.</p>					
2. 1020060121073		<b>SNOW SHOE EQUIPPED AT A TIRE, FOR REINFORCING THE HEAVY LOAD OF THE WHEEL BY COVERING THE COVER AT THE SNOW SHOE</b>		KR	28.11.2006
B60C 27/00	 1020050044747		KIM, YEONG CHEON		KIM, YEONG CHEON
<p>PURPOSE: A <b>snow shoe</b> equipped at a tire is provided to improve the auxiliary usage performance when having a flat tire and prevent the vehicle from being slid by mounting the <b>snow shoe</b> pedal.</p> <p>CONSTITUTION: A vehicle having a <b>snow shoe</b> equipped at a tire is composed of the <b>snow shoe</b> reinforcing the heavy load of the wheel and preventing the wheel from being slid on the icy road at the sudden stop, by covering a cover at the <b>snow shoe</b>; a single diameter wheel cylinder mounted on the cover of the wheel shaft; a coupling inner gear operated by the operation of the single diameter wheel cylinder; a return spring returning the coupling inner gear; a coupling support frame; a <b>snow shoe</b> main opening and closing valve mounted at the front of the driving seat; a <b>snow shoe</b> pedal opening and closing valve connected to the <b>snow shoe</b> main opening and closing valve; and a <b>snow shoe</b> pedal installed together with the brake. The <b>snow shoe</b> is composed of a driving pinion, a driven pinion; a <b>snow shoe</b>-plate extension fixing rod, a <b>snow shoe</b>-plate extension adjusting bolt; a bevel gear shoe-plate extension rod; and a <b>snow shoe</b>-plate(4a).</p> <p>© KIPO 2007</p>					
3. 105495841		<b>Snow shoe with electric heating insole</b>		CN	20.04.2016
A43B 7/02	 201410488456.7		GUCHENG NO.3 MIDDLE SCHOOL		DING FENGYUE
<p>The invention provides a <b>snow shoe</b> with an electric heating insole. The <b>snow shoe</b> is characterized in that the charging heating insole is arranged in a shoe sole of the <b>snow shoe</b>, and a charging jack of the insole is positioned on a side of the shoe sole. The <b>snow shoe</b> has the advantages that heat energy can be generated by the insole after the insole is charged at low temperatures in winters, and accordingly the inside of the <b>snow shoe</b> can keep in warm states for a long time.</p>					

EN\_ALLTXT:aspirin AND PA:Novartis AND DP:[2008 TO 2010]



EN\_AB:(((windturbine OR wind?) OR (eol<sup>10</sup> OR aeolian) OR aerofoil<sup>0.8</sup> OR rotor<sup>15</sup>))





# Keywords

- Stemming
- Wildcard
- Truncation
- Fuzzy





# Stemming



Advanced Search 

Search For:  

Expand with related terms 

Language:   **Stem:**  Office:  All

Instant Help  Tooltip Help

 Search  Reset

# Stemming

- Stem = stemming
- Process that removes common endings from words.

critical

critically

criticism

criticisms

critics

each word is reduced to 'critic'

# Stemming

- no dictionary includes the necessary technical terms to express patent concepts
  - Porter Stemming Algorithm finds words that contain common roots
  - Save time and effort
- 

Refine Search

EN\_AB:(metal support)

Search

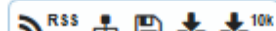

## Analysis

Countries		IPC		Inventor		Applicant		Pub Date	
Name	No	Name	No	Name	No	Name	No	Date	No
United Kingdom	52,827	B01J	23,548	Кочетов Олег Савельевич (RU)	169	FUJI PHOTO FILM CO LTD	816	1993	2,338
United States	39,963	H01L	11,297	THE INVENTOR HAS WAIVED THE RIGHT TO BE MENTIONED	152	BRITISH THOMSON HOUSTON CO LTD	727	1994	2,245
China	31,947	B01D	8,752	DAI CHANGHONG	126	SIEMENS AG	663	1995	2,320
Japan	28,298	C07C	8,644	Kochetov Oleg Savelevich (RU)	119	MATSUSHITA ELECTRIC IND CO LTD	605	1996	2,748
European Patent Office	16,397	H01M	6,119	VERZICHT DES ERFINDERS AUF NENNUNG	93	GEN ELECTRIC	502	1997	2,819
PCT	13,745	H01J	5,963	WANG WEI	82	Fuji Photo Film Co., Ltd.	479	1998	5,660
Republic of Korea	10,714	B21D	5,815			TOYOTA MOTOR CORP	455	1999	5,862
Canada	7,107	F04R	5,441					2000	6,273

Sort by: Relevance

View All

List Length 10

Machine translation

Int.Class	Appl.No	Title	Applicant	Ctr	PubDate
1. WO/2006/016633		EXHAUST GAS PURIFYING CATALYST AND PRODUCTION PROCESS THEREOF		WO	16.02.2006
B01J 23/40	PCT/JP2005/014707		TOYOTA JIDOSHA KABUSHIKI KAISHA	IBE, Masaya	
<p>The present invention relates to an exhaust gas purifying catalyst comprising first and second metal oxide supports and a noble metal supported thereon, wherein the first and second metal oxide supports both have a primary particle diameter of less than 100 nm, primary particles of the first and second metal oxide supports are mixed with each other, and the amount of the noble metal supported per unit surface area of the first metal oxide support is larger than the amount of the noble metal supported per unit surface area of the second metal oxide support. Further, the present invention relates to a production process of the exhaust gas purifying catalyst.</p>					
2. WO/2000/006298		METAL COMPLEXES SUITABLE FOR ATTACHMENT TO A SUPPORT AND SUPPORTED METAL COMPLEXES		WO	10.02.2000
B01J 31/16	PCT/GB1999/002427		THE UNIVERSITY COURT OF THE UNIVERSITY OF ST ANDREWS	GANI, David	

A functionalised support for use in the preparation of a supported metallic complex which comprises a polymer backbone bearing at least a functionalised site able to react with and bind at least one metallic atom or a metallic complex. A supported metallic complex obtained using the functionalised support, a metallic complex comprising at least one metallic atom and a ligand suitable to be attached to a polymer support, and a supported metallic complex obtained by attaching the metallic complex on a polymer support and their uses as catalysts.

Refine Search EN\_AB:(metal support)

Search



Analysis

Countries		IPC		Inventor		Applicant		Pub Date	
Name	No	Name	No	Name	No	Name	No	Date	No
United States	20,132	B01J	13,028	Кочетов Олег Савельевич (RU)	134	FUJI PHOTO FILM CO LTD	520	1993	1,177
United Kingdom	19,561	H01L	5,311	Kochetov Oleg Savelevich (RU)	101	Fuji Photo Film Co., Ltd.	406	1994	1,121
China	17,421	B01D	4,533	THE INVENTOR HAS WAIVED THE RIGHT TO BE MENTIONED	81	SIEMENS AG	283	1995	1,210
Japan	11,177	C07C	4,485	WANG TAO	54	EASTMAN KODAK CO	239	1996	1,435
European Patent Office	8,312	C10G	2,924	DAI CHANGHONG	49	BRITISH THOMSON HOUSTON CO LTD	238	1997	1,456
PCT	7,144	H01M	2,920	WANG WEI	47	JOHNSON MATTHEY PLC	238	1998	2,501
Republic of Korea	5,069	E04B	2,617	VERZICHT DES ERFINDERS AUF	46	FUJIFILM CORP	230	1999	2,589
Canada	3,538	B21D	2,613					2000	2,787

Sort by: Relevance View All List Length 10 Machine translation

Int.Class	Appl.No	Title	Applicant	Ctr	PubDate
1. WO/2014/047087	B01J 37/02	PROCESS FOR PRE-TREATMENT OF A CATALYST SUPPORT AND CATALYST PREPARED THEREFROM	LYONDELL CHEMICAL TECHNOLOGY, L.P.	WO	27.03.2014
	PCT/US2013/060257				
				SHAY, Daniel Travis	
<p>Methods of forming noble metal catalysts, noble metal catalysts formed therefrom and process for using noble metal catalysts are described herein. The methods generally include contacting support material with a pre-treatment agent including a dilute basic solution of an alkali or alkaline earth metal to form a contacted support; drying the contacted support to form a pre-treated support; and impregnating the pre-treated support with at least one noble metal to form the noble metal catalyst.</p>					
2. 20130309165	B01J 23/00	Metal structure catalyst and preparation method thereof	Kee Young Koo	US	21.11.2013
	13980895				
				Kee Young Koo	

Provided are a metal structure catalyst and a method of preparing the same. Particularly, the method includes forming a metal precipitate on a metal support by contact of a mixed solution including a precursor of a metal catalyst and a precipitating agent with the metal support, and forming metal particles by thermally

# Wildcards/truncation : ? \*





- \* stands for 0 or more characters
- ? stands single character

te?t = test or text

electric\* = electrical; electricity

behavi\*r = behaviour or behavior

micro?p\* = microspeaker, microsporidial

Title		Ctr	PubDate
Int.Class	Appl.No	Applicant	Inventor
1. <a href="#">1993/05842</a> METHOD FOR FORMING ULTRA-MICROAPERTURES IN THIN THERMOPLASTIC FILM MATERIALS AND PRODUCTS FORMED THEREBY		ZA	25.05.1994
B29K	 1993/05842	KIMBERLY-CLARK CORPORATION	BERNARD COHEN
<p>The invention is directed toward a method for forming a generally uniform pattern of ultra-<a href="#">microapertures</a> in a thermoplastic film. The method includes the steps of: (a) forming a generally uniform pattern of <a href="#">microapertures</a> in a thermoplastic film; and (b) heating the <a href="#">microapertured</a> film in an unconstrained condition to a temperature where the <a href="#">microapertures</a> shrink to ultra-<a href="#">microaperture</a> size.</p>			
2. <a href="#">2090075</a> METHOD FOR FORMING ULTRA-MICROAPERTURES IN THIN THERMOPLASTIC FILM MATERIALS AND PRODUCTS FORMED THEREBY		CA	24.03.1994
C08J 9/36	 2090075		COHEN, BERNARD
<p>ABSTRACT OF THE DISCLOSURE The invention is directed toward a method for forming a generally uniform pattern of ultra-<a href="#">microapertures</a> in a thermoplastic film. The method includes the steps of: (a) forming a generally uniform pattern of <a href="#">microapertures</a> in a thermoplastic film; and (b) heating the <a href="#">microapertured</a> film in an unconstrained condition to a temperature where the <a href="#">microapertures</a> shrink to ultra-<a href="#">microaperture</a> size.</p>			
3. <a href="#">0589225</a> Method for forming ultra-microapertures in thin thermoplastic film materials and products formed thereby.		EP	30.03.1994
B26F 1/26	 93113531	KIMBERLY CLARK CO	COHEN BERNARD
<p>The invention is directed toward a method for forming a generally uniform pattern of ultra-<a href="#">microapertures</a> in a thermoplastic film (14). The method includes the steps of: (a) forming (38) a generally uniform pattern of <a href="#">microapertures</a> in a thermoplastic film; and (b) heating (76) the <a href="#">microapertured</a> film in an unconstrained condition to a temperature where the <a href="#">microapertures</a> shrink to ultra-<a href="#">microaperture</a> size.</p>			
4. <a href="#">2001172059</a> REDUCED PRESSURED DOUBLE GLAZING AND METHOD FOR PRODUCING THE SAME		JP	26.06.2001
E06B 3/66	 2000025125	CENTRAL GLASS CO LTD	KOBAYASHI KAZUYA
<p>PROBLEM TO BE SOLVED: To obtain a reduced pressured double glazing having transparency and heat insulating properties by using spacers such as tiny <a href="#">microspacers</a> of spherical spacers having 1 mm diameter and to provide a method for setting the tiny <a href="#">microspacers</a> at predetermined positions.</p> <p>SOLUTION: This reduced pressured double glazing glass is produced by setting two plate glasses with a predetermined space, setting <a href="#">microspacers</a> having magnetism, sealing the peripheral part of the panel with a sealer and reducing the pressure of the inner space of the glasses. The method for setting the <a href="#">microspacer</a> comprises adsorbing a sheet having holes with a specified space to an vacuum adsorbing plate, putting the <a href="#">microspacers</a> in the holes to arrange them with the specified space and a pattern, contacting the sheet arranged with the <a href="#">microspacers</a> to a glass and fixing the <a href="#">microspacer</a> using a magnet.</p> <p>COPYRIGHT: (C)2001,JPO</p>			
5. <a href="#">102591616</a> Device and method for determining floating point computing performance		CN	18.07.2012
G06F 7/57	 201110449841.7	Beijing Paratera Technology Co., Ltd.	The inventor has waived the right to be mentioned

# Use of wildcards

- Spelling uncertainty (plural, tenses, foreign words):

tyre vs. tire ➡ t\*re

University vs Universität ➡ Universit\* Stuttgart

- Multiple spelling variants are known:

color vs. colour ➡ col\*

- Preferred option over stemming:

electric vs. electricity ➡ electri\*



# Wildcard vs stemming

- Logic results:

- *navy, navies* or *naval* if *nav\** = *navigating, navigation,*

- *electricity* or *electric* if *elect\** = *electoral*

# Fuzzy searches

■ Use of the tilde: ~

■ Examples:

roam~       $\longrightarrow$       foam / roams

Roam~0.8



Useful to find misstpyed, misspelt or mis-OCRed words

Q: when you use wildcard, ...

A

The results retrieved are all relevant

B

Stemming is turned off

Q: when you use wildcards, ...

A

The results retrieved are all relevant

B

Stemming is turned off

^ caret = weighting factor

- Same result but ranking will be different

touch<sup>3</sup> AND polarize

Refine Search EN\_AB: (touch AND polarize)

Search



## Analysis

Countries		IPC		Inventor		Applicant		Pub Date	
Name	No	Name	No	Name	No	Name	No	Date	No
China	604	G06F	1,315	HASHIMOTO TAKAO	17	SAMSUNG ELECTRONICS CO., LTD.	58	2008	88
United States	520	G02F	854	Matsumoto Kenichi	16	엘지디스플레이 주식회사	47	2009	86
Japan	507	G02B	386	NISHIKAWA KAZUHIRO	16	LG DISPLAY CO., LTD.	45	2010	96
Republic of Korea	334	H01L	195	TAKAHATA KAZUHIKO	15	삼성전자주식회사	40	2011	133
PCT	248	B32B	170	MURAKAMI YUKIO	14	BOE TECHNOLOGY GROUP CO., LTD.	39	2012	105
European Patent Office	99	G09F	144	Tanabe Koji	14	NITTO DENKO CORPORATION	37	2013	166
United Kingdom	99	G09G	130	SAITO TOMOHISA	13	삼성디스플레이 주식회사	33	2014	221
Australia	23	H05B	58	齋藤 智久	13	DONGWOO FINE-CHEM CO., LTD.	32	2015	246

Sort by: Relevance

View All

List Length 10

Machine translation

Int.Class	Appl.No	Title	Applicant	Ctr	PubDate
1. 20170299909	G02F 1/1333	SWITCHABLE TYPE TOUCH DISPLAY DEVICE AND METHOD OF DRIVING THE SAME	LG Display Co., Ltd.	US	19.10.2017
	15637611		Chung-Hwan AN		
<p>A switchable type <b>touch</b> display device includes: a display panel displaying an image; a <b>touch polarization</b> control panel over the display panel, wherein the <b>touch polarization</b> control panel includes: first and second <b>touch polarization</b> control substrates; a first electrode on an inner surface of the first <b>touch polarization</b> control substrate; a second electrode on an inner surface of the second <b>touch polarization</b> control substrate; a third electrode on an outer surface of the second <b>touch polarization</b> control substrate; and a <b>polarization</b> control liquid crystal layer between the first and second <b>touch polarization</b> control substrates; and a lens panel over the <b>touch polarization</b> control panel.</p>					
2. 20150177549	G02F 1/1335	Switchable type touch display device and method of driving the same	LG Display Co., Ltd.	US	25.06.2015
	14506831		Chung-Hwan An		

A switchable type **touch** display device includes: a display panel displaying an image; a **touch polarization** control panel over the display panel, wherein the **touch polarization** control panel includes: first and second **touch polarization** control substrates; a first electrode on an inner surface of the first **touch polarization** control substrate; a second electrode on an inner surface of the second **touch polarization** control substrate; a third electrode on an outer surface of the second **touch polarization** control substrate; and a **polarization** control liquid crystal layer between the first and second **touch polarization** control substrates; and a lens panel over the **touch polarization** control panel.

Refine Search EN\_AB: (touch^3 AND polarize)

Search



## Analysis

Countries		IPC		Inventor		Applicant		Pub Date	
Name	No	Name	No	Name	No	Name	No	Date	No
China	604	G06F	1,315	HASHIMOTO TAKAO	17	SAMSUNG ELECTRONICS CO., LTD.	58	2008	88
United States	520	G02F	854	Matsumoto Kenichi	16	엘지디스플레이 주식회사	47	2009	86
Japan	507	G02B	386	NISHIKAWA KAZUHIRO	16	LG DISPLAY CO., LTD.	45	2010	96
Republic of Korea	334	H01L	195	TAKAHATA KAZUHIKO	15	삼성전자주식회사	40	2011	133
PCT	248	B32B	170	MURAKAMI YUKIO	14	BOE TECHNOLOGY GROUP CO., LTD.	39	2012	105
European Patent Office	99	G09F	144	Tanabe Koji	14	NITTO DENKO CORPORATION	37	2013	166
United Kingdom	99	G09G	130	SAITO TOMOHISA	13	삼성디스플레이 주식회사	33	2014	221
Australia	23	H05B	58	齋藤 智久	13	DONGWOO FINE-CHEM CO., LTD.	32	2015	246

Sort by: Relevance

View All

List Length 10

Machine translation

Int.Class	Appl.No	Title	Applicant	Ctr	PubDate
1. 20170299909	G02F 1/1333	SWITCHABLE TYPE TOUCH DISPLAY DEVICE AND METHOD OF DRIVING THE SAME	LG Display Co., Ltd.	US	19.10.2017
	15637611			Chung-Hwan AN	
<p>A switchable type touch display device includes: a display panel displaying an image; a touch polarization control panel over the display panel, wherein the touch polarization control panel includes: first and second touch polarization control substrates; a first electrode on an inner surface of the first touch polarization control substrate; a second electrode on an inner surface of the second touch polarization control substrate; a third electrode on an outer surface of the second touch polarization control substrate; and a polarization control liquid crystal layer between the first and second touch polarization control substrates; and a lens panel over the touch polarization control panel.</p>					
2. 20150177549	G02F 1/1335	Switchable type touch display device and method of driving the same	LG Display Co., Ltd.	US	25.06.2015
	14506831			Chung-Hwan An	
<p>A switchable type touch display device includes: a display panel displaying an image; a touch polarization control panel over the display panel, wherein the touch</p>					

1. 20170299909 SWITCHABLE TYPE TOUCH DISPLAY DEVICE AND METHOD OF DRIVING THE SAME	US	19.10.2017
G02F 1/1333	15637611	LG Display Co., Ltd.
<p>A switchable type touch display device includes: a display panel displaying an image; a touch polarization control panel over the display panel, wherein the touch polarization control panel includes: first and second touch polarization control substrates; a first electrode on an inner surface of the first touch polarization control substrate; a second electrode on an inner surface of the second touch polarization control substrate; a third electrode on an outer surface of the second touch polarization control substrate; and a polarization control liquid crystal layer between the first and second touch polarization control substrates; and a lens panel over the touch polarization control panel.</p>		
2. 20150177549 Switchable type touch display device and method of driving the same	US	25.06.2015
G02F 1/1335	14506831	LG Display Co., Ltd.
<p>A switchable type touch display device includes: a display panel displaying an image; a touch polarization control panel over the display panel, wherein the touch polarization control panel includes: first and second touch polarization control substrates; a first electrode on an inner surface of the first touch polarization control substrate; a second electrode on an inner surface of the second touch polarization control substrate; a third electrode on an outer surface of the second touch polarization control substrate; and a polarization control liquid crystal layer between the first and second touch polarization control substrates; and a lens panel over the touch polarization control panel.</p>		

3. 1020150046809 TOUCH PANEL WITH POLARIZER AND DISPLAY DEVICE COMPRISING SAME	KR	04.05.2015
G06F 3/041	1020130125980	엘지디스플레이 주식회사
<p>An integral touch panel with a polarizer according to the present invention includes: a touch panel and an upper polarizer integrally formed with the touch panel. The upper polarizer includes: a first polarizing layer; a first bearing layer which supports the first polarizing layer; a first adhesion layer formed on the first bearing layer; and a second adhesion layer formed on the first polarizing layer. The present invention provides a display device for an integral touch panel with a polarizer which improves poor touch recognition from contraction of the polarizer occurred during adhesion process of a cell, a polarizer, and a touch panel; simplifies the manufacturing process of the display device; and decreases the thickness of the display device for the integral touch panel with a polarizer. COPYRIGHT KIPO 2015</p>		

4. 104111752 Touch display module and touch screen with touch display module used	CN	22.10.2014
G06F 3/041	201410256459.8	SHENZHEN PENGDAYUAN ELECTRONIC TECHNOLOGY CO., LTD.
<p>A touch display module comprises a touch polarization layer and a display module body. The touch polarization layer comprises a polarizer and a touch layer formed on the surface of the polarizer, and the touch polarization layer and the display module body are completely fit or a gap is formed between the touch polarization layer and the display module body. According to the touch display module, the touch layer is formed on the polarizer in a screen printing or plating and carving mode to form the touch polarization layer, the processing difficulty of light and thin touch display modules is reduced, the yield of the touch display modules is increased, and the production cost of the touch display modules is lowered.</p>		

5. 1020040056751 METHOD FOR MANUFACTURING TOUCH PANEL INTEGRATING POLARIZED PANEL	KR	01.07.2004
G02F 1/1333	1020020083306	LG-PHILIPS LCD CO., LTD.
<p>PURPOSE: A method for manufacturing a touch panel integrating a polarized panel is provided to attach an upper polarized plate and a touch panel at the state of an original plate and thereafter perform a cutting, thereby solving an attaching error and a size variation simultaneously because the upper polarized plate and the touch panel maintains the same size.</p> <p>CONSTITUTION: A touch panel original plate and an upper polarized plate are adhered in a laminating apparatus. The adhered touch panel plate(310a) and the upper polarized plate(320a) are cut according to the size of each touch panel. When adhering the touch panel original plate and the upper polarized plate, the laminating must be performed toward a direction corresponding to the lower polarized plate. That is, in the upper and lower polarized plates, the directions of their absorption shafts coincide with each other.</p>		

1. 20170299909 SWITCHABLE TYPE TOUCH DISPLAY DEVICE AND METHOD OF DRIVING THE SAME	US	19.10.2017
G02F 1/1333	15637611	LG Display Co., Ltd.
<p>A switchable type touch display device includes: a display panel displaying an image; a touch polarization control panel over the display panel, wherein the touch polarization control panel includes: first and second touch polarization control substrates; a first electrode on an inner surface of the first touch polarization control substrate; a second electrode on an inner surface of the second touch polarization control substrate; a third electrode on an outer surface of the second touch polarization control substrate; and a polarization control liquid crystal layer between the first and second touch polarization control substrates; and a lens panel over the touch polarization control panel.</p>		
2. 20150177549 Switchable type touch display device and method of driving the same	US	25.06.2015
G02F 1/1335	14506831	LG Display Co., Ltd.
<p>A switchable type touch display device includes: a display panel displaying an image; a touch polarization control panel over the display panel, wherein the touch polarization control panel includes: first and second touch polarization control substrates; a first electrode on an inner surface of the first touch polarization control substrate; a second electrode on an inner surface of the second touch polarization control substrate; a third electrode on an outer surface of the second touch polarization control substrate; and a polarization control liquid crystal layer between the first and second touch polarization control substrates; and a lens panel over the touch polarization control panel.</p>		

3. 2733588 Touch panel display device	EP	
G06F 3/041	13167353	SAMSUNG DISPLAY CO LTD
<p>A touch panel display device including a display panel displaying an image; a polarizing plate attached onto the display panel; a touch panel from an upper portion of the polarizing plate; a resin layer between the touch panel and the polarizing plate, the resin layer bonding the touch panel; a window on the touch panel; and a reinforcement layer between the window and the touch panel or between the touch panel and the window, wherein the reinforcement layer prevents damage to the touch panel caused by bending stress.</p>		

4. 20040212749 Method for fabricating touch panel integrated liquid crystal display device	US	
G02F 1/13	10740509	LG.Philips LCD Co., Ltd.
<p>The present invention discloses a method of fabricating a touch panel for a liquid crystal display device including forming a parent touch panel and a parent polarizer, laminating the parent touch panel and the parent polarizer, and cutting the laminated parent touch panel and the parent polarizer into a plurality of single touch panel units and forming a plurality of polarizer integrated touch panels.</p>		

5. 1020150046809 TOUCH PANEL WITH POLARIZER AND DISPLAY DEVICE COMPRISING SAME	KR	04.05.2015
G06F 3/041	1020130125980	엘지디스플레이 주식회사
<p>An integral touch panel with a polarizer according to the present invention includes: a touch panel and an upper polarizer integrally formed with the touch panel. The upper polarizer includes: a first polarizing layer; a first bearing layer which supports the first polarizing layer; a first adhesion layer formed on the first bearing layer; and a second adhesion layer formed on the first polarizing layer. The present invention provides a display device for an integral touch panel with a polarizer which improves poor touch recognition from contraction of the polarizer occurred during adhesion process of a cell, a polarizer, and a touch panel; simplifies the manufacturing process of the display device; and decreases the thickness of the display device for the integral touch panel with a polarizer.</p>		

6. WO/2016/206022 TOUCH DEVICE AND PREPARATION METHOD THEREFOR	WO	
G06F 3/041	PCT/CN2015/082240	SHENZHEN ROYOLE TECHNOLOGIES CO., LTD.
<p>A touch device (100) and a preparation method therefor. The touch device (100) comprises a first substrate (102), a first touch layer (104), a second touch layer (108), and a second substrate (110). The first touch layer (104) and the second touch layer (108) are adhered to a polarization layer (106) respectively. The first substrate (102) is disposed on the first touch layer (104). The second substrate (110) is disposed on the second touch layer (108).</p>		



# Advanced search interface

- Search syntax
- Search fields

Q Search | Browse | Translate | News

Home > IP Services > PATENTSCOPE

Advanced Search

Search For:

Expand with related terms ↓

Language: English Stem:  Office: + All

Instant Help  Tooltip Help

Q Search Reset

- User Guide PATENTSCOPE
- User Guide: Cross Lingual Expansion
- User Guide: ChemSearch
- Query Syntax
- Fields Definition
- Country Code

- How to Search
- Data Coverage
- FAQ
- Feedback&Contact
- INID codes
- Kind codes
- Tutorials
- About

# Tooltip help

The screenshot shows the WIPO PATENTSCOPE search interface. At the top left is the WIPO logo. To its right is the text 'PATENTSCOPE' and 'Search International and National Patent Collections'. Further right are language options: Mobile | Deutsch | Español | Français | 日本語 | 한국어 | Português | Русский | 中文 | العربية. Below this is a navigation bar with 'Search', 'Browse', and 'Translate'. A breadcrumb trail reads 'Home > IP Services > PATENTSCOPE'. The main section is titled 'Advanced Search'. A search box contains the query 'EN\_TI:micr?p\* OR EN\_AB:micr?p\*'. Below the search box is a link 'Expand with related terms'. At the bottom left, there are settings for 'Language: English', 'Stem: [checked]', and 'Office: + All'. At the bottom right are 'Instant Help [checked]' and 'Tooltip Help [checked]' checkboxes, and 'Search' and 'Reset' buttons. A tooltip is overlaid on the search box, titled 'Samples of searches:', and lists four examples: 'wind turbine - general searches, looking everywhere', 'EN\_ALLTXT:(wind turbine) - all the text fields are searched, the relevance of top results is of high quality', 'ALLNAMES:(Mao Yumin) - looking for applicant, inventor, agent names', and 'ALLNUM:(DK 2008 123) - looking for IDs, WO, PCT numbers'.

**WIPO** PATENTSCOPE  
Search International and National Patent Collections

WORLD INTELLECTUAL PROPERTY ORGANIZATION

Mobile | Deutsch | Español | Français | 日本語 | 한국어 | Português | Русский | 中文 | العربية

Search | Browse | Translate

Home > IP Services > PATENTSCOPE

Advanced Search

Search For: EN\_TI:micr?p\* OR EN\_AB:micr?p\*

Expand with related terms

Language: English Stem:  Office: + All

Instant Help  Tooltip Help  Search Reset

**Samples of searches:**

- wind turbine - general searches, looking everywhere
- EN\_ALLTXT:(wind turbine) - all the text fields are searched, the relevance of top results is of high quality
- ALLNAMES:(Mao Yumin) - looking for applicant, inventor, agent names
- ALLNUM:(DK 2008 123) - looking for IDs, WO, PCT numbers

# Help

## Advanced Search

Search For:



[Expand with related terms](#) ↓

Language:

English



Stem:

Office:



All

[Instant Help](#)

Tooltip Help

Search

Reset

# Instant help

- Validates search query
- Suggests terms
- Provides list of:
  - IPC codes
  - countries

## Advanced Search

Search For:



Expand with related terms ↓

Language:  Stem:  Office:  All

Instant Help  Tooltip Help

## Advanced Search

Search For:



Please enter a valid field... (or use UP/DOWN keys, and TAB or ENTER to select)

Exp

1 锅

2 过

3 国

4 郭

5 果

6 裹

7 號



Language:  Stem:  Office:  All

Instant Help  Tooltip Help



Advanced Search 

Enter a value...

Search For:  DP: 

Language:  2018  
 201809  
 20180923  
 23.09.2018  
 [01.01.2018 TO "\*\*"]  
 [01.01.2018 TO 31.12.2018]  
 [201709 TO 201809]  
 [2017 TO 2018]

Instant Help



Advanced Search 

Enter a value...

Search For:  IC: 

Language:  A: SECTION A - HUMAN NECESSITIES  
 **B: SECTION B - PERFORMING OPERATIONS; TRANSPORTING**  
 C: SECTION C - CHEMISTRY; METALLURGY  
 D: SECTION D - TEXTILES; PAPER  
 E: SECTION E - FIXED CONSTRUCTIONS  
 F: SECTION F - MECHANICAL ENGINEERING; LIGHTING; HEATING; WEAPONS; BLASTING  
 G: SECTION G - PHYSICS  
 H: SECTION H - ELECTRICITY  
 \*

Instant Help

# Question mark help

Advanced Search

Search For:

[Expand with related terms](#) ↓

Language:  Stem:  Office:  All

Instant Help  Tooltip Help

- ◀ "electric car"~50
- ◀ EN\_ALLTXT:"electric car"~50
- ◀ ALLNAMES:(Mao Yumin)
- ◀ ALLNUM:(DK 2008 123)
- ◀ DP:[01.01.2000 TO 01.01.2001]
- ◀ elec\*ty
- ◀ (EN\_TI:electric^10 EN\_AB:"electric car") OR DE:solar^3

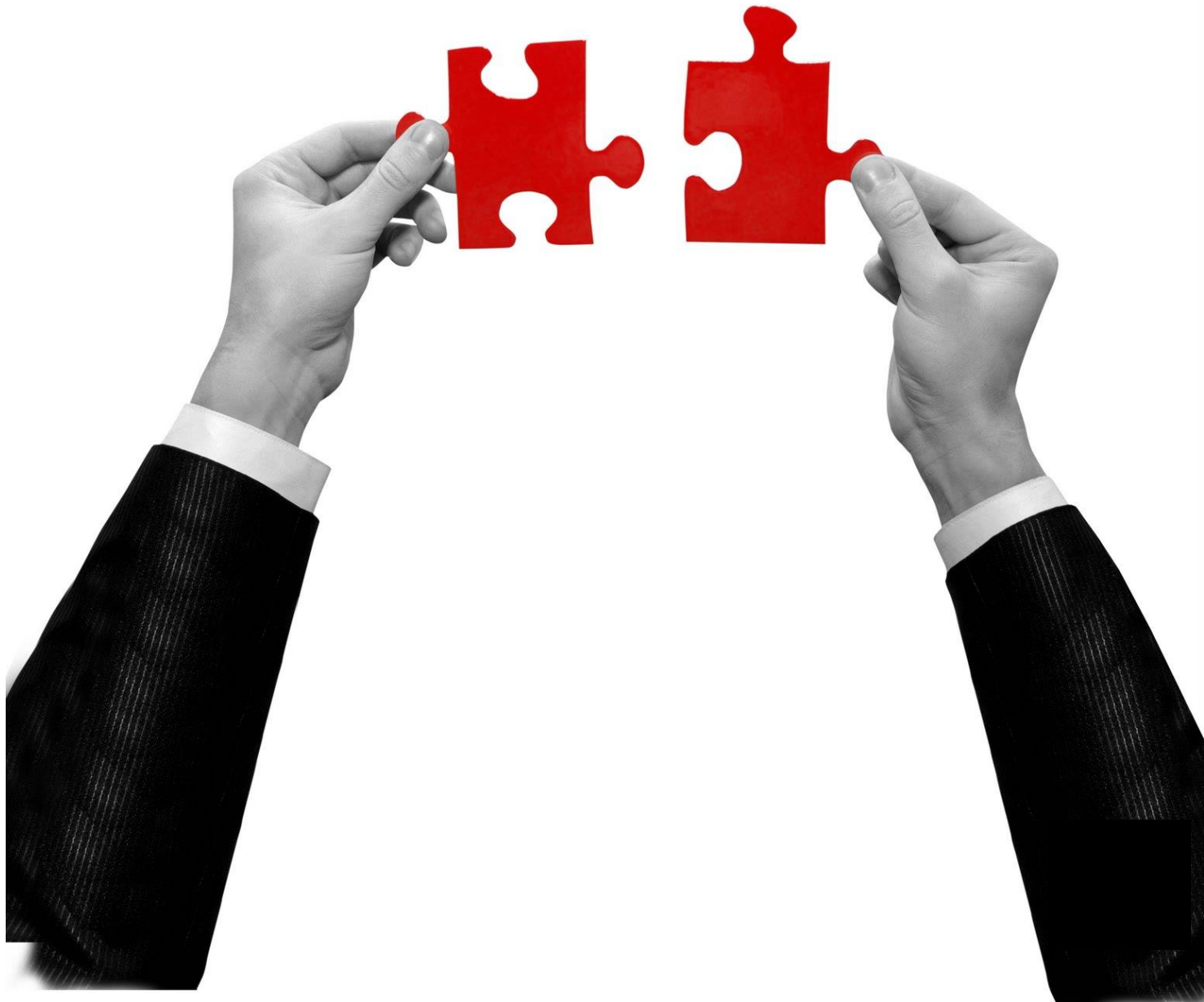



# Result combination

- Combine search with chemical structure search
- Combine search with CLIR

Refine Search EN\_ALLTXT:viagra AND DP:[2005 TO 2015]

Search



Analysis

Countries		IPC		Inventor		Applicant		Pub Date	
Name	No	Name	No	Name	No	Name	No	Date	No
United States	1,829	A61K	2,664	Andre David	61	CADBURY ADAMS USA LLC	113	2005	282
PCT	932	A61P	1,144	Stivoric John M.	61	CELGENE CORPORATION	53	2006	402
European Patent Office	344	C07D	681	Teller Eric	61	MONOSOL RX, LLC	53	2007	346
Australia	320	G06F	275	Monocello, III John A.	56	GEBRESECLASSIE, Petros	52	2008	444
Canada	280	A23G	228	GEBRESECLASSIE, Petros	52	BOGHANI, Navroz	51	2009	394
Japan	97	C07K	207	BOGHANI, Navroz	51	BodyMedia, Inc.	50	2010	409
China	50	A61F	186	Boghani Navroz	41	PFIZER INC.	47	2011	363
Republic of Korea	43	C12N	172	Gebreselassie Petros	40	Celgene Corporation	44	2012	352

Sort by: Relevance View All List Length 10 Machine translation

Int.Class	Appl.No	Title	Applicant	Ctr	PubDate
1. 20090246298	<a href="#">Viagra</a>			US	01.10.2009
A61K 36/00	12009258		CEOLA P. STEELE		Steele Ceola Pattiee

1. Couch Grass works on the prostate gland to clear it of bacteria. If this bacteria is allowed to build up it could cause arthritis neuralgia, cancer, and neurological problems. The blood is cleaned by the Magistral [Viagra](#) and hormones are activated. Couch Grass is in the carrot family, it is potent. The potency of Couch Grass is 10 to 1 it is 10x more potent than carrots. It is very high in potassium.

- 2. Stale Red Clover, quantity of herb to be used is, judged on the weight of 150 pound man. This herb contains ammonia fixing bacteria, it works on the kidneys. The sodium, potassium cells of the kidneys are activated. Salts and potassium cells of the kidneys are activated. Salts and potassium work on the gut to produce a super abundant amount of energy, water is the catalyst for the production of hormones in the blood. These hormones travel through out the body in the blood. They work on the principle of vasodilation and vasoconstriction. I want to focus on the vasoconstriction.
  - 3. Skull Cap works on the body using the volatile fixed oils, (essential oil) The main color titrated out is green, green works on the heart. In the

Results 1-10 of 21,158 for Criteria:CHEM:(BNRN XUUZRGQAQC-UHFFFAOYSA-N) Office(s):all Language:EN Stemming: true

Page: 1 / 2116 Go

Refine Search CHEM:(BNRN XUUZRGQAQC-UHFFFAOYSA-N) AND DP:[2005 TO 2015]

Search

RSS     10k

Analysis

Countries		IPC		Inventor		Applicant		Pub Date	
Name	No	Name	No	Name	No	Name	No	Date	No
United States	7,322	A61K	18,457	Gant Thomas G.	147	BRISTOL-MYERS SQUIBB COMPANY	287	1993	1
PCT	4,691	A61P	9,245	Sarshar Sepehr	101	PFIZER INC.	257	1994	2
Japan	3,142	C07D	7,926	Toleikis Philip M.	75	Bristol-Myers Squibb Company	237	1996	1
China	2,243	C07K	1,432	GANT, Thomas, G.	74	MERCK SHARP & DOHME CORP.	218	1997	4
European Patent Office	1,619	C12N	1,099	Gravett David M.	74	AUSPEX PHARMACEUTICALS, INC.	211	1998	15
Republic of Korea	1,469	C07C	1,009	Maiti Arpita	71	Pfizer Inc.	182	1999	54
EAPO	433	G01N	895	Hunter William L.	63	PFIZER LIMITED	173	2000	164
		A01N	630	Toni WEINSCHENK	63	BAYER PHARMA AKTIENGESELLSCHAFT	168	2001	327

Sort by: Relevance View All List Length 10 Machine translation

Int.Class	Title	Applicant	Ctr	PubDate
1. 106132204	Sildenafil solutions and methods of making and using same		CN	16.11.2016
A01N 43/90	201580013951.5	VIGOROUS SOLUTIONS LTD.		ROGOSNITZKY MOSHE

The invention discloses sildenafil solutions and methods of making and using the same. The invention relates to compositions containing dissolved sildenafil citrate and methods of producing such compositions, wherein sildenafil citrate is dissolved in water mixed with one or more alcohols, and optionally a ketone may be used to enhance solubility. The invention also relates to methods of using such compositions containing dissolved sildenafil citrate utilizing dosages significantly below existing therapeutic dosages of sildenafil citrate.

Results 1-10 of 14,660 for Criteria:CHEM:(BNRN XUZR GQAQC-UHFFFAOYSA-N) AND DP:[2005 TO 2015] Office(s):all Language:EN Stemming: true

Refine Search CHEM:(BNRN XUZR GQAQC-UHFFFAOYSA-N) AND DP:[2005 TO 2015]

Search

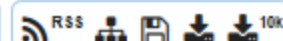

Analysis

Countries		IPC		Inventor		Applicant		Pub Date	
Name	No	Name	No	Name	No	Name	No	Date	No
United States	4,975	A61K	12,959	Gant Thomas G.	147	AUSPEX PHARMACEUTICALS, INC.	190	2005	998
PCT	3,249	A61P	7,051	Sarshar Sepehr	101	Bristol-Myers Squibb Company	185	2006	958
Japan	2,238	C07D	5,717	GANT, Thomas, G.	74	BRISTOL-MYERS SQUIBB COMPANY	174	2007	1,009
China	1,471	C07K	773	Toleikis Philip M.	72	PFIZER INC.	142	2008	1,363
European Patent Office	1,261	C07C	739	Gravett David M.	71	MERCK SHARP & DOHME CORP.	133	2009	1,378
Republic of Korea	1,006	C12N	549	Maiti Arpita	69	PFIZER LIMITED	125	2010	1,730
EAPO	297	A01N	520	Hunter William L.	62	Merck Sharp & Dohme Corp.	100	2011	1,424
		C01N	457	SARSHAR Sepehr	49	Pfizer Inc	95	2012	1,315

Sort by: Relevance View All List Length 10 Machine translation

Int.Class	Title	Appl.No	Applicant	Ctr	PubDate
1. 102174474	Sildenafil monoclonal antibody and colloidal gold chromatography test strip used for detecting sildenafil			CN	07.09.2011
C12N 5/20		201110004723.5	Nantong Egens Biology Technic Co., Ltd.		Ou Weijun

The invention belongs to the field of medicament inspection and discloses a sildenafil monoclonal antibody and a colloidal gold chromatography test strip used for detecting sildenafil. The sildenafil monoclonal antibody is generated by a hybridoma cell line with the collection number of CCTCC No. C2010123. The sildenafil monoclonal antibody has highly uniform physical and chemical properties, single bioactivity and high specificity of combining the antigen sildenafil, is convenient to perform artificial treatment and quality control, and can be used for preparing the colloidal gold chromatography test strip for detecting the sildenafil. In the colloidal gold chromatography test strip for detecting sildenafil, the gold-labelled antibody coated on a gold-labelled combination pad is the colloidal gold marker of the sildenafil monoclonal antibody. By using the colloidal gold chromatography test strip, no any reagent and instrument are required, and site operation can be performed; and after a sample is mixed with an extraction solution, the supernatant is taken for detection, the detection result can be obtained within 5-10 minutes, and the method is simple, convenient and rapid and has high timeliness.

Results 1-10 of 8,163 for Criteria:(car OR 车) AND ANA:CN Office(s):all Language:EN Stemming: true

Refine Search (car OR 车) AND ANA:CN

Search

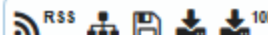

Analysis

Countries		IPC		Inventor		Applicant		Pub Date	
Name	No	Name	No	Name	No	Name	No	Date	No
PCT	8,163	G06F	568	LIU, Quan	50	HUNAN ZOOMLION SPECIAL VEHICLE CO., LTD.	244	1993	3
		A61K	527	LIU, Qiuming	48	CHANGSHA ZOOMLION HEAVY INDUSTRY SCIENCE AND TECHNOLOGY DEVELOPMENT CO., LTD.	188	1994	3
		H04W	340	WEI, Zhilin	48	ZOOMLION HEAVY INDUSTRY SCIENCE AND TECHNOLOGY CO., LTD.	166	1995	5
		A61P	301	XIANG, Zhiyong	48	HUawei TECHNOLOGIES CO., LTD.	164	1996	9
		H04L	297	ZHAN, Chunxin	48	SZ DJI TECHNOLOGY CO., LTD.	145	1997	8
		H04N	282	NIU, Jianhua	47	LE HOLDINGS (BEIJING) CO., LTD.	124	1998	16
		C07D	277	CHE, Zhanbin	41	TENCENT TECHNOLOGY (SHENZHEN) COMPANY LIMITED	122	1999	22
		C12N	244	YU Ainin	31			2000	22

Sort by: Relevance View All List Length 10 Machine translation

Int.Class	Appl.No	Title	Applicant	Ctr	PubDate
1. WO/2009/038551		MULTIPLE CAR HOISTWAY INCLUDING CAR SEPARATION CONTROL		WO	26.03.2009
B65B 1/24	PCT/US2007/020142		OTIS ELEVATOR COMPANY		WANG, Cheng-Shuo
<p>A separation distance is maintained between a leading elevator car (14) and a trailing elevator car (12) traveling in the same direction in an elevator hoistway (16). A shortest stopping distance (dssl) of the leading elevator car (14) and a normal stopping distance (dnst) of the trailing elevator car (12) are determined. The separation distance (dsep) is controlled such that a difference between the normal stopping distance (dnst) of the trailing elevator car (12) and the shortest stopping distance (dssl) of the leading elevator car (14) is greater than or equal to a threshold distance (dthresh).</p>					

2. WO/2010/071676 ELEVATOR CAR

WO/07.06.2010

Results 1-10 of 4,474 for Criteria:car AND ANA:CN Office(s):all Language:EN Stemming: true

Page: 1 / 448 Go

Refine Search car AND ANA:CN

Search

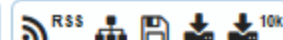

Analysis

Countries		IPC		Inventor		Applicant		Pub Date	
Name	No	Name	No	Name	No	Name	No	Date	No
PCT	4,474	A61K	455	FENG, Wei	19	HUAWEI TECHNOLOGIES CO., LTD.	154	1993	3
		G06F	415	HAN, Yaochuan	18	SZ DJI TECHNOLOGY CO., LTD.	145	1994	3
		H04W	290	XIA, Wenjin	18	TENCENT TECHNOLOGY (SHENZHEN) COMPANY LIMITED	122	1995	5
		C07D	243	XU, Wenhui	18	BASF SE	104	1996	9
		A61P	235	YANG, Qinyao	18	INTEL CORPORATION	84	1997	8
		C12N	222	WANG, Lei	17	BASF (CHINA) COMPANY LIMITED	78	1998	16
		H04L	220	WENG, Fuliang	17	QUALCOMM INCORPORATED	62	1999	22
		H04N	188	RIERGARD, Anthony P	16	NOKIA CORPORATION	56	2000	22

Sort by: Relevance View All List Length 10 Machine translation

Int.Class	Appl.No	Title	Applicant	Ctr	PubDate
1. WO/2009/038551		MULTIPLE CAR HOISTWAY INCLUDING CAR SEPARATION CONTROL		WO	26.03.2009
B65B 1/24	PCT/US2007/020142		OTIS ELEVATOR COMPANY		WANG, Cheng-Shuo

A separation distance is maintained between a leading elevator car (14) and a trailing elevator car (12) traveling in the same direction in an elevator hoistway (16). A



Search For: \*

car|

Query Language: English

Expansion Mode: Automatic

Precision 1 Recall

Submit Query

Results 1-10 of 3,047,647 for Criteria:CHEM:((EN\_TI:("car" OR "wagon") OR EN\_AB:("car" OR "wagon")) OR (DA\_TI:("godsvogn" OR "vogn" OR "togvogne" OR "platform" OR "bund") OR DA\_AB:("godsvogn" OR "vogn" OR "togvogne" OR "platform" OR "bund")) OR (DE\_TI:("Wagen" OR "Kraftfahrzeug" OR "Waggon" OR "Eisenbahnwagen" OR "Güterwagen" OR "Schienenfahrzeug" OR "Fahrzeuges" OR "Förderwagens" OR "Schienentragwagens")) OR DE\_AB:("Wagen" OR "Kraftfahrzeug" OR "Waggon" OR "Eisenbahnwagen" OR "Güterwagen" OR "Schienenfahrzeug" OR "Fahrzeuges" OR "Förderwagens" OR "Schienentragwagens")) OR (ES\_TI:("vagón" OR "carro" OR "coche") OR ES\_AB:("vagón" OR "carro" OR "coche")) OR (FR\_TI:("wagon" OR "véhicule" OR "voiture") OR FR\_AB:("wagon" OR "véhicule" OR "voiture")) OR (IT\_TI:("piamento" OR "cabina" OR "vagopne" OR "carrozze ferroviarie" OR "vagone") OR IT\_AB:("piamento" OR "cabina" OR "vagopne" OR "carrozze ferroviarie" OR "vagone")) OR (JA\_TI:("車両" OR "車内" OR "ワゴン" OR "貨車" OR "による") OR JA\_AB:("車両" OR "車内" OR "ワゴン" OR "貨車" OR "による")) OR (KO\_TI:("전동차용" OR "차량설비" OR "철도차량용 기기" OR "루프" OR "운전실의") OR KO\_AB:("전동차용" OR "차량설비" OR "철도차량용 기기" OR "루프" OR "운전실의")) OR (NL\_TI:("gen" OR "wagon") OR NL\_AB:("gen" OR "wagon")) OR (PL\_TI:("wagonu" OR "wóz" OR "składający" OR "wagonowych" OR "drogowo") OR PL\_AB:("wagonu" OR "wóz" OR "składający" OR "wagonowych" OR "drogowo")) OR (PT\_TI:("vagão" OR "carro") OR PT\_AB:("vagão" OR "carro")) OR (RU\_TI:("вагона" OR "вагонетки") OR RU\_AB:("вагона" OR "вагонетки")) OR (SV\_TI:("vagn" OR "rälsgående") OR SV\_AB:("vagn" OR "rälsgående")) OR (ZH\_TI:("车厢" OR "货车" OR "轿车" OR "车用" OR "换车" OR "汽车" OR "阻") OR ZH\_AB:("车厢" OR "货车" OR "轿车" OR "车用" OR "换车" OR "汽车" OR "阻")) Office(s):all Language:EN Stemming: true

# Most common errors

- (.....) "..."
- " not “
- Field name
- No space
- Wildcard at the beginning of a word



# IPCCAT

An IPC Symbol or terms



Results

Advanced Search



**Terms search:**

Stemming

A01N,A01I Limit to

A01N,A01I Exclude

Path

Scheme titles

Scheme references

Catchwords

Definitions

IPCPUB v7.7 - 03.12.2018

CPC 08.2018, FI 01.11.2018

Scheme RCL Compilation Catchwords

- A HUMAN NECESSITIES**
- B PERFORMING OPERATIONS; TRANSPORTING**
- C CHEMISTRY; METALLURGY**
- D TEXTILES; PAPER**
- E FIXED CONSTRUCTIONS**
- F MECHANICAL ENGINEERING; LIGHTING; HEATING; WEAPONS; BLASTING**
- G PHYSICS**
- H ELECTRICITY**

An IPC Symbol or terms



Results

Advanced Search

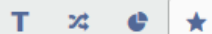

**Categorization (IPCCAT):**

3 Number of predictions

SubGr Classification level

Default Language

A01N Start From

**IPCPUB v7.7 - 03.12.2018**

**CPC 08.2018, FI 01.11.2018**

Scheme

RCL

Compilation

Catchwords



A

**HUMAN NECESSITIES**



B

**PERFORMING OPERATIONS; TRANSPORTING**



C

**CHEMISTRY; METALLURGY**



D

**TEXTILES; PAPER**



E

**FIXED CONSTRUCTIONS**



F

**MECHANICAL ENGINEERING; LIGHTING; HEATING; WEAPONS; BLASTING**



G

**PHYSICS**



H

**ELECTRICITY**

# IPCC

iameter compared to the outlet.

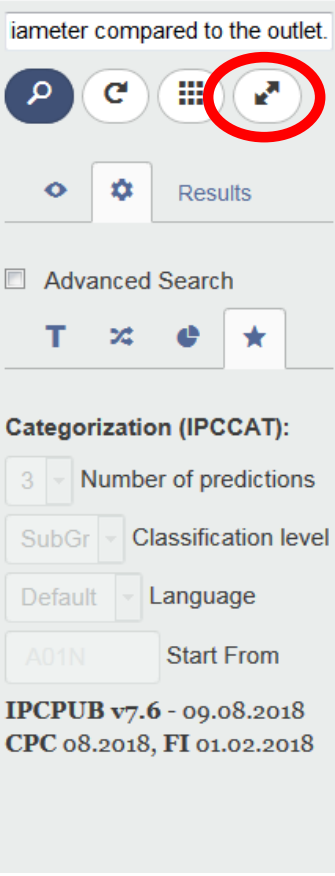

Advanced Search

Number of predictions: 3

Classification level: SubGr

Language: Default

Start From: A01N

IPCPUB v7.6 - 09.08.2018  
CPC 08.2018, FI 01.02.2018

### Search text field

According to various embodiments, a method and system to obtain access to a blood vessel underneath a skin layer that may preserve lifespan of the blood vessel and reduce executional skill variability may be provided. The method includes placing a guiding portion between the blood vessel and the skin layer; and configuring the guiding portion to receive and guide a needle to reach the same location of the blood vessel repeatedly and consistently; and forming a resultant scarred track between the blood vessel and the skin layer as the guiding portion is resorbed over time. The system includes a vascular access device configurable to first possess strength to penetrate through a tissue layer, subsequently possess flexibility to conform to the surrounding tissue beneath the tissue wherein the inlet is resorbable, outlet.

Ordered by relevance:

- A61B 18/00
- A61M 39/00
- A61M 5/00

IPCPUB v7.6 - 09.08.2018  
CPC 08.2018, FI 01.02.2018

Save

PONS; BLASTING