



Welcome to our online training session:

Introduction to Intellectual Property and Intellectual Property Rights

European IPR Helpdesk,
August 29th, 2018



Get your ticket to innovation.



Road Map

- *Intellectual Property & Intellectual Property Rights*
- *IP Rights asset value*
- *IP protection tools & costs of IP rights*
- *IP monitoring & searches*
- *Where to get more information*





What is meant by "intellectual property" and "intellectual property rights"?

Intellectual Property



European
IPR Helpdesk

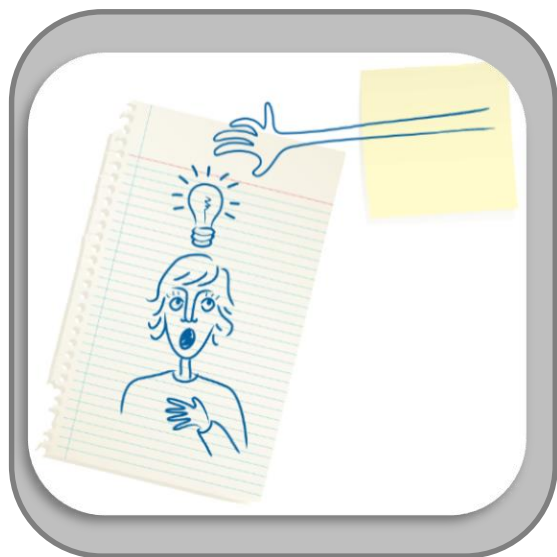

Such creations
have an intangible
nature

Results of creative
efforts from the
human intellect

**Intellectual
Property**

Intellectual Property Vs Intellectual Property Rights

- *Intellectual Property (IP)*

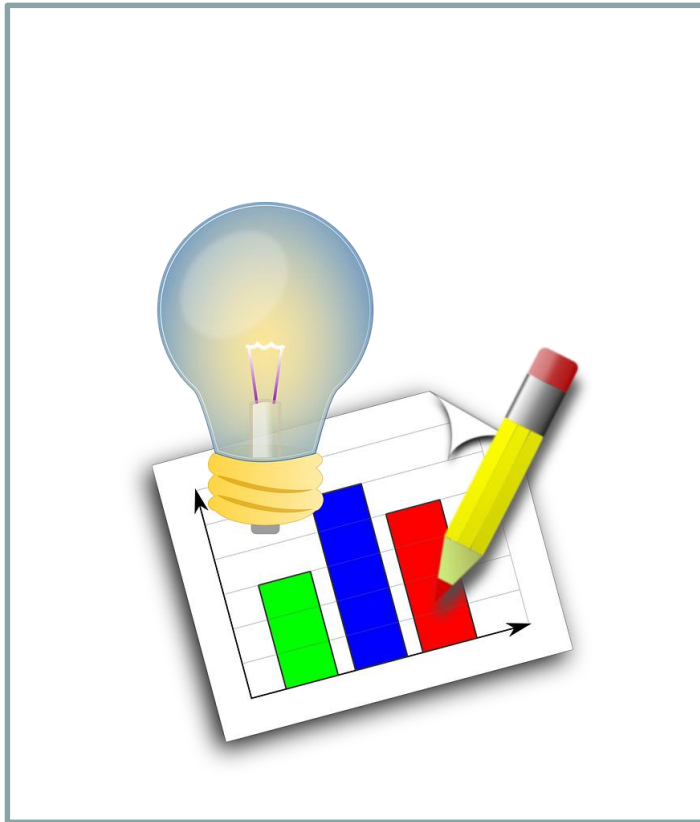

≠

- **Intellectual property rights (IPR)**

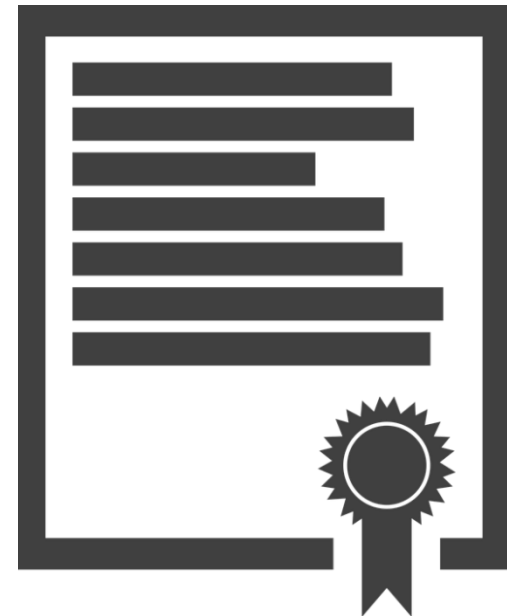

Intellectual Property Rights



European
IPR Helpdesk

UNREGISTRABLE

COPYRIGHT & Related rights
Literary & Artistic Works
Related rights
Databases ...

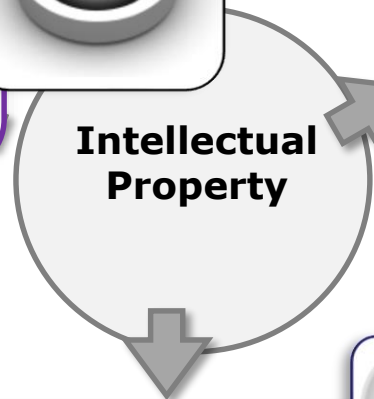

INDUSTRIAL PROPERTY
Trade Marks
Patents
Utility Models
Industrial Designs...



REGISTRABLE

'SOFT IP'
Trade Secrets
Know-How
Confidential Information





*Which are the Intellectual
Property protection tools
available?*

Industrial Property



- **Patents** and **utility models**: inventions
- **Industrial designs**: innovative designs
- **Trade Marks**: brands
- And other rights (such as Geographical Indications), but not covered on this module

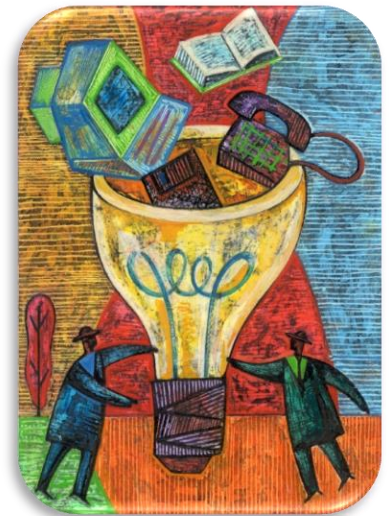

Principle of Territoriality

- *IP rights are territorial rights. In general, the exclusive rights are only applicable in the country or region in which a patent has been filed and granted, in accordance with the law of that country or region.*



Rights Conferred

- *An IP right grants to its owner a monopoly on the product of the mind protected. Nobody without his authorization may use, commercialize etc. the protected item.*

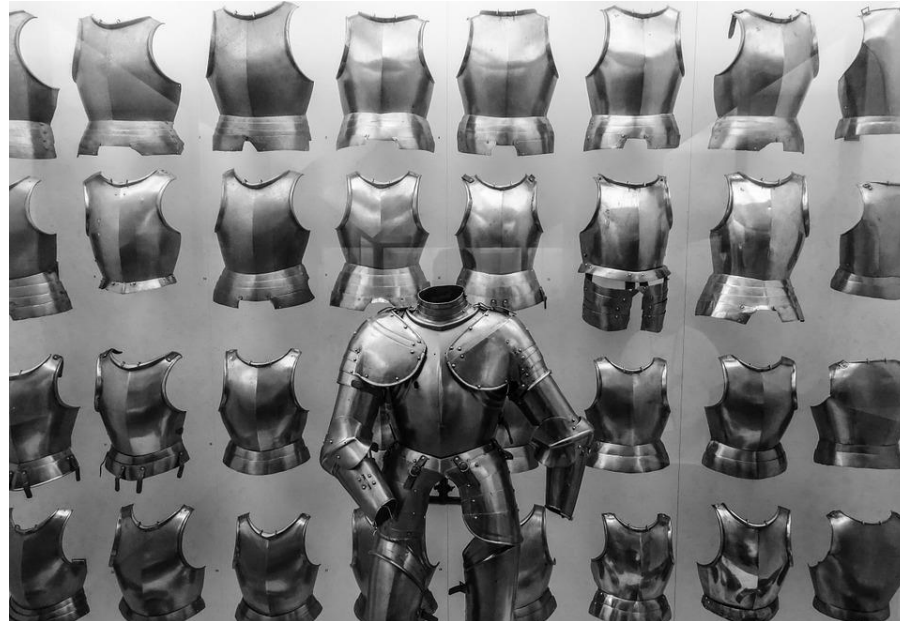

Duration of the protection

- *Intellectual Property rights grant a monopoly on the intellect creation for a limited amount of time depending on the type of right that is protected.*
- **Copyrights 70 years after the death of the author**
- **Patents 20 years after the filing**
- **Industrial designs 25 five years after the registration**
- **Trademarks indefinitely as long as renewal fees are payed**



Relevance of intellectual property Rights for the tourist sector:



European
IPR Helpdesk

Beyond Exclusivity!

Intellectual Property Rights are an **opportunity** for:

- Advertising:
- Merchandizing:
- Franchising:
- Certifying:

Relevance of intellectual property Rights for the tourist sector:



Beyond Exclusivity!

Intellectual Property Rights are an **opportunity** for:

- Advertising:



Relevance of intellectual property Rights for the tourist sector:



European
IPR Helpdesk

Beyond Exclusivity!

Intellectual Property Rights are an **opportunity** for:

- Merchandizing:

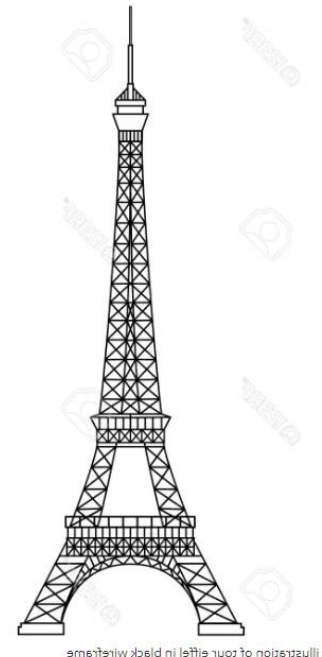

Relevance of intellectual property Rights for the tourist sector:



European
IPR Helpdesk

Beyond Exclusivity!

Intellectual Property Rights are an **opportunity** for:

- Franchising:



Relevance of intellectual property Rights for the tourist sector:



European
IPR Helpdesk

Beyond Exclusivity!

Intellectual Property Rights are an **opportunity** for:

- Certifying:



What is a trade mark (TM)?

It is a **sign**, or a combination of signs, used in trade to identify and distinguish the goods or services of one enterprise from those of another. A trade mark owner is granted exclusive rights to:

- *use the mark in relation to the goods or services with respect to which it is registered*
- *prevent others from using a substantially identical or deceptively similar mark in relation to identical or similar goods or services.*

What can be protected as trade mark?

Words, letters, numerals, pictures, shapes and colours, as well as any combination of the above.

The registration of less traditional forms of trade marks is now allowed, such as three-dimensional signs (like the Coca-Cola bottle), audible signs (sounds, Nokia jingle), or olfactory signs (smells).

Trade Mark Examples



European
IPR Helpdesk



I amsterdam.®

Trade Mark Requirements



European
IPR Helpdesk

Which are the requirements to seek registration?

In order for a sign to be eligible for trade mark protection, it must:

- *Be distinctive*
- *Not be deceptive*
- *Not be descriptive*
- *Not belong to the exclusions provided by the law*
- *Be in conformity with public order and morality.*

**Duration of
protection:
10 years,
renewable
indefinitely**

Trade Mark Registration



European
IPR Helpdesk

How to register a trade mark?

NATIONAL TM

Applications must be filed before your **National TM Office** accompanied by:

- a clear reproduction of the mark including any colours, forms, or three-dimensional features,
- list of goods or services to which the mark would apply.

Registrations can be cancelled in case of non-use.

COMMUNITY TM

One single application, in one official language may be filed at the Office for the Harmonisation of the **EUIPO in Alicante – Spain.**

INTERNATIONAL

By filing an international application, TM protection can be obtained in each states member of the Madrid system, designated by the applicant.

Applications may be submitted:

- **to your National trademark Office**
- **to the EUIPO**
- **to the WIPO.**

Patents



What is a patent?

It is a title providing the *inventor* and/or the *applicant* with the **exclusive right** to prevent others from possessing, using, selling, manufacturing and importing the patented **invention** or offering to do any of these things within a territory.

What can be patented?

Patents may be granted for any invention concerned with the *functional* and *technical* aspects of *products* and *processes*. To qualify for patent protection the invention must fulfil the so-called

conditions of patentability:

- **Patentable subject matter**
- **Novelty**
- **Inventive step (non-obviousness)**
- **Industrial Applicability (utility)**

[European Patent Convention](#)

Patentable subject matter

Inventions are patentable, with the following exclusions (Art 52 EPC):

- *Discoveries, scientific theories and mathematical methods;*



$$E=MC^2$$

- *Aesthetic creations;*

- *Schemes, rules and methods for performing mental acts, playing games or doing business, and programs for computers:*



- *Presentations of information.*



- **Art 54: European Patent Convention:**

An invention shall be considered to be new if it does not form part of the state of the art.

State of the art : Everything made available to the public by means of a written or oral description, by use, or in any other way, before the date of filing of the European patent application.

Evaluate carefully disclosure and dissemination activities



Art 57 European Patent Convention:

- An invention shall be considered as susceptible of industrial application if it can be made or used in any kind of industry, including agriculture.

Patents



Patent Registration



What are my options?

NATIONAL PATENT

In general, an application filed before your National Patent **Office (NPO)** must be accompanied by:

- a specification containing a detailed description of the invention,
- one or more claims,
- any drawings referred to in the description or claims and an abstract
- the required filing fee.

INTERNATIONAL REGISTRATION

By filing an international application, patent protection can be obtained in each designated states amongst 148 worldwide. PCT applications may be submitted:

- **to your NPO,**
- **to the EPO, or**
- **to the WIPO.**



EUROPEAN PATENT

- One single application, in one official language may be filed:
- at your NPO, or
- At the EPO
- The EPO grants patents having the effect of a **national patent in designated countries (currently max. 38)**. You may decide to maintain it in force in some or all of them.

EUROPEAN PATENT With Unitary effect

- One single application, written in French, English or German will grant a title that is going to be valid throughout the 26 European countries. (Turkey Norway etc... are excluded)
- It will be active when the [Unified Patent Court Agreement](#) will be ratified

The Unified patent court



European
IPR Helpdesk

Will be competent for all European patents, including also those with Unitary effect.

Affected by BREXIT????

Established by the [Unified Patent Court Agreement](#)

Website:
<https://www.unified-patent-court.org/>

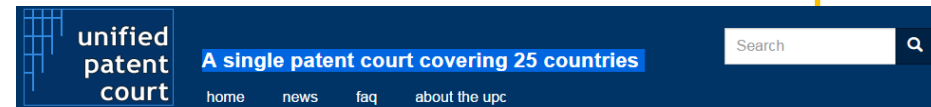

About the UPC

The Unified Patent Court (UPC) will be a court common to the Contracting Member States and thus part of their judicial system. It will have exclusive competence in respect of European patents and European patents with unitary effect. The exclusive competence is however subject to exceptions during the transitional period. The UPC's rulings will have effect in the territory of those Contracting Member States having ratified the UPC Agreement at the given time. The UPC will not have any competence with regard to national patents.

The UPC Agreement is open to accession by any Member State of the European Union. The Agreement is not open to states outside of the European Union. Up to date, all European Union Member States except Spain and Poland have signed the

The preparatory committee

The Preparatory Committee is composed of all the Signatory States to the [Unified Patent Court Agreement \(16351/12\)](#) (see also [Regulations 1257/2012](#) and [1260/2012](#)). All these states undertook to establish the new court and the Preparatory Committee's function is to oversee the various work streams. There are five major work streams which will constitute the work which needs to be completed. These are:

- Legal framework
- Financial aspects
- Information technology
- Facilities, and
- Human resources & Training

The Preparatory Committee will exist until the Court is established. Currently this is expected to last two years and during this time it will have its own [Rules by which it is governed](#). Its work programme is set out in a [Roadmap](#). Its [external communication plan](#) outlines how it will update users and stakeholders, by what means and the type of documents that will appear on this website.

The Committee has endorsed the brochure titled '[An Enhanced European Patent System](#)' which provides a useful overview.



Chair
Alexander Ramsay
Sweden

Cases

[Click here to log into the UPC Case Management System](#)

Latest News

[Alexander Ramsay's interview with EUROFORUM on the Unitary Patent and the Unified Patent Court](#)

15 December 2015

[13th meeting of the Preparatory Committee – 7 & 8 December 2015](#)

09 December 2015

[Unified Patent Court – Rules of procedure](#)

27 October 2015

[12th meeting of the Preparatory Committee – 19 October 2015](#)

20 October 2015

[Protocol to the UPC Agreement](#)

01 October 2015

[more »](#)

Update:



- EPO published a [Unitary Patent Guide](#): August 2017

Unitary Patent guide

Obtaining, maintaining and managing Unitary Patents



1st edition, August 2017

The "Unitary Patent Guide" aims to provide companies, inventors and their representatives with an outline of the procedure involved in obtaining a Unitary Patent from the European Patent Office (EPO) once it has granted a European patent on the basis of the provisions laid down in the European Patent Convention (EPC).

Download

[Unitary Patent guide \(PDF, 823 KB\)](#)

Utility Models: A faster and reduced option for inventions protection



What is a utility model?

It is a title of protection for certain **inventions**, such as inventions in the mechanical field. Utility models are usually sought for technically less complex inventions or for inventions that have a short commercial life.

In the EU only **17 countries** provide a registration process for utility models. The latter is significantly **simpler and faster than the patent application process**, taking - on average - six months. Finally, utility models are much **cheaper** to obtain and to maintain.

Utility Models

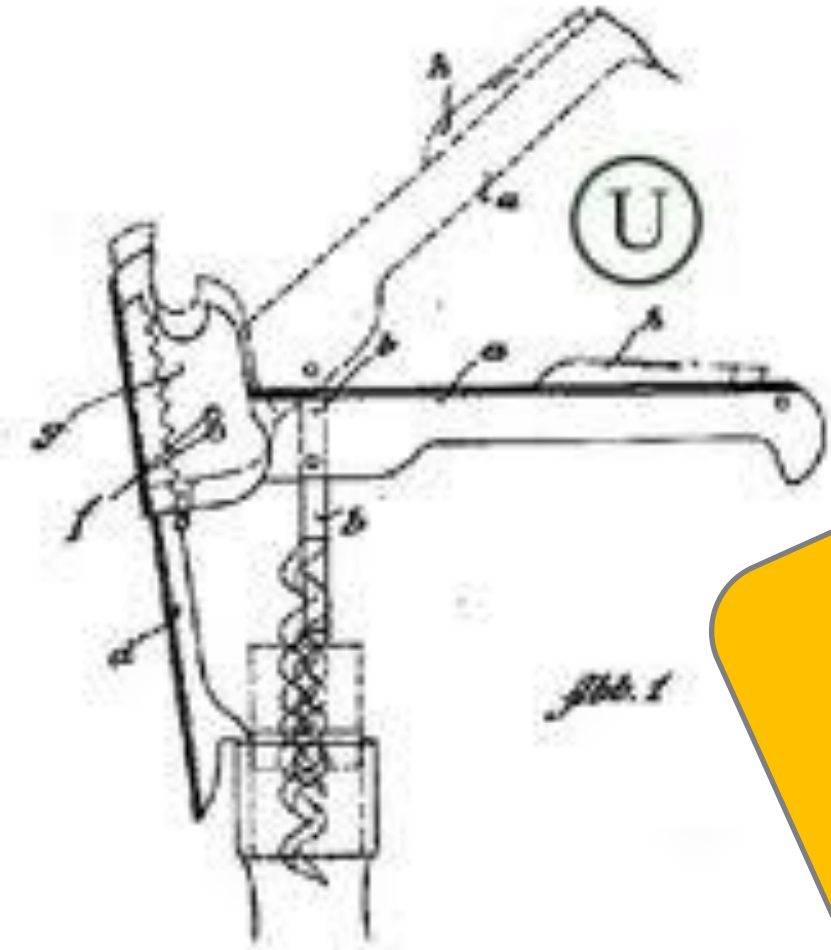

**Duration of
protection:
between 6 & 10
years**



What is an industrial design?

It refers to the right granted to protect the **original, ornamental and non-functional** features of a product that result from design activity. The right concerns merely the appearance (the 'design') of a product, not the product itself.

What can be protected?

An industrial design may be granted in relation to the visual features of a product (i.e. shape, ornamentation, pattern, configuration, etc.). Designs that are dictated solely by the article's function are excluded from protection.

To qualify for protection the design must show:

- **Novelty**
- **Individual character**



Industrial Designs



**Duration of
protection: up to 25
years, without
renewal**

Design Registration



European
IPR Helpdesk

How to register a design?

NATIONAL DESIGN

An application must be filed before your **National Intellectual Property Office (NIPO)**, accompanied by any representation of the design suitable for reproduction.

COMMUNITY DESIGN

One single application, in one official language may be filed at the **EUIPO in Alicante – Spain.**

INTERNATIONAL REGISTRATION

By filing a single international application to **WIPO in Geneva**, you may be able to obtain design protection in several states that are members of The Hague system.

Factsheet:



- Design Searching:

European IPR Helpdesk
www.iprhelpdesk.eu

European IPR Helpdesk
Fact Sheet
Design searching

December 2015

1. Design searching	2
1.1. Why performing design searching	2
2. Searching unregistered designs	4
3. Design search databases	4
3.1. Designview (OHIM)	5
3.2. The Global Design Database (WIPO)	7
3.3. The Hague Express Database (WIPO)	8
4. Analyses of the design searching results	10

Introduction

Design protection confers on the design holder an exclusive right to use a design - making, offering, putting on the market, importing, exporting or using the product in which the design is incorporated or to which it is applied - and to prevent third parties from using it commercially without its prior consent. In principle, design rights are acquired through registration within national or regional intellectual property offices. The European Union and some national legislations provide for unregistered design protection. Furthermore, in most European countries, original designs are subject to copyright protection, which arises automatically from the moment of the work's creation without registration.

For all the aforementioned forms of design protection the first-come, first-served principle applies¹. Risks of investing in non-original design or filing an application for identical or confusingly similar design can be avoided or at least limited by performing design searching.

¹ Unregistered design rights come into force when the design is made available to the public. Registered design protection begins when a filing date is granted.



Copyright

- **Does not protect the ideas themselves but only the concrete form of expression of ideas**
- **The creativity protected is the originality of the authored work!**



What are copyright and related rights?

Copyright protects **literary and artistic works**, such as poems, novels, music and paintings, but also cinematographic works, architectural works and many others.

Related rights are related to the protection of works of authorship under copyright. Their purpose is to protect the legal interests of certain persons and legal entities who contribute to making works available to the public such as performing artists, producers of phonograms, broadcasters, etc.

What are the rights granted?

Copyright owners can prohibit or authorise that their works be:

- *copied or reproduced (e.g. printed publications or sound recordings)*
- *distributed to the public*
- *performed in public*
- *translated into other languages*
- *adapted, such as novel into screenplay...*

Copyright



Do I need to apply for copyright protection?

- No formal registration process is required
- Copyright **protection arises automatically** upon creation of the work, provided that it is **original**.

Generally,
protection lasts
for 70 years after
the death of the
creator





What is "soft IP"?

Confidential business information



No specific definition

The terms “Soft IP” can be used to describe the intellectual assets which are not included in industrial property or in literary and artistic works, but have an important value for organisations. Usually, this refers to know-how, trade secrets, confidential information.

Protection of Soft IP

- Is not achieved by registration
- Falls under the category of intangible rights – associated with other IPR
- Free of charge
- Does not involve long or complex registration processes , BUT requires appropriate internal management



What are the costs of IP rights?

Costs of IPR

Approximately, the costs of the different IPR are as follows:

- **Patent:**
 - *National:* estimated examination and delivery between 20 € (Estonia) and 900 € (Finland)
 - *European:* estimated examination and delivery 5.600 €
(7 countries or more) (Cost reduction foreseen with unitary patent protection)
 - Unitary Patent? Not yet clear. Translation costs should be much lower (only three official languages), as well as litigation cost (regulated all over Europe by the European Patent court)
- **Trade mark:**
 - *National:* estimated examination and delivery between 11 € (Estonia) and 440 € (Italy)
 - *European:* estimated examination and delivery 900 €
- **Industrial design:**
 - *National:* estimated examination and delivery between 6.50 € (Estonia) and 430 € (Finland)
 - *European:* estimated examination and delivery 350 €



European
IPR Helpdesk





STOP

IP monitoring & searches

IP Monitoring & Searches



European
IPR Helpdesk

Regularly searching IP databases and other resources is important in order to:

- check novelty
- check availability of a trade mark or design
- check priority of competing products and services
- have a look at your competitors' products and services
- check expiration date of other IPRs
- carry on a market study
- make sure you do not infringe third parties' rights
- detect third parties' alleged infringements

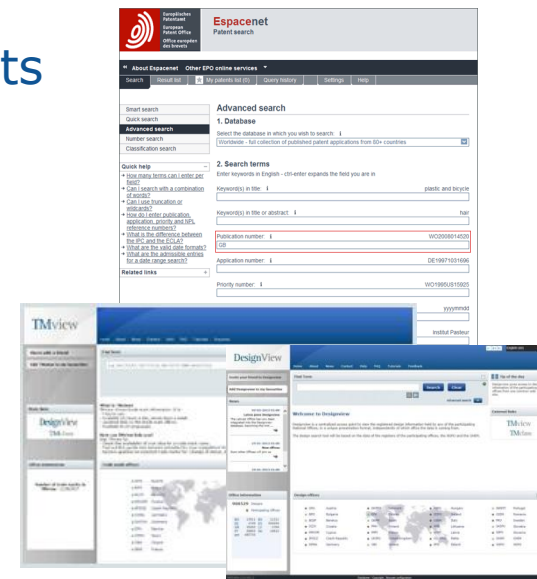



Refine search → Results

- Smart search
- Advanced search
- Classification search

Quick help -

Result list

Select all (0/7) Compact Export (CSV | XLS) Download covers Print

7 results found in the Worldwide database for:
(txt = glyceemic and txt = control) and txt = sensor using Smart search

- Can I subscribe to an RSS feed of the result list?
- What does the RSS reader do with the result list?
- Can I export my result list?
- What happens when I click "Download"?
- Why is my search result not showing up?

Sort by Upload date Sort order Descending Sort

Search Result list My

Refine search → Results

- Smart search
- Advanced search
- Classification search

...IBRIUM INTRAVASCULAR SENSOR TO ACHIEVE TIGHT GLYCEMIC CONTROL

Applicant: GLUMETRICS INC [US]	CPC: A61B5/14532 A61B5/14539 A61B5/1459 (+3)	IPC: A61B5/145	Publication info: US2014018646 (A1) 2014-01-16	Priority date: 2007-11-21
-----------------------------------	--	-------------------	--	------------------------------

...NING GLYCEMIC CONTROL BASED ON GLUCOSE ACTIVITY MEASUREMENTS

Applicant: GLUMETRICS INC [US] ANTHONY P	CPC: A61B5/14503 A61B5/14532 A61B5/14539 (+10)	IPC: A61B5/00	Publication info: WO2011075711 (A1) 2011-06-23	Priority date: 2009-12-17
--	--	------------------	--	------------------------------

...IC CONTROL

Applicant:	CPC: A61B5/0002 A61B5/14503 A61B5/14532 (+2)	IPC: A61M5/14 G06F19/00	Publication info: US2010280499 (A1) 2010-11-04	Priority date: 2007-12-26
------------	--	-------------------------------	--	------------------------------

...APPARATUSES RELATED TO BLOOD ANALYTE MEASUREMENT SYSTEM

Inventor: ROBINSON MARK RIES [US] PATTERSON WILLIAM R [US] (+3)	Applicant:	CPC: A61B5/14 A61B5/1405 A61B5/1427 (+6)	IPC: A61B5/00	Publication info: US2010168535 (A1) 2010-07-01	Priority date: 2006-04-12
---	------------	--	------------------	--	------------------------------



Awareness Raising

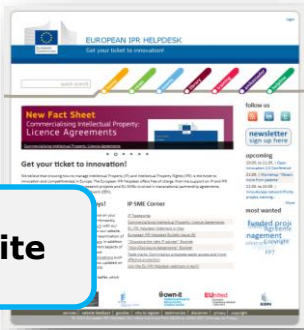

Website



Helpline



Training

Services

Bulletin



Newsletter



Publications

All of our services are offered free of charge.



Thank you.

We look forward to getting in touch with you!

For further questions and general IP advice, please contact our Helpline team:

service@iprhelphdesk.eu

Phone +352 25 22 33-333 (Helpline)

Fax + 352 25 22 33-334 (Helpline)

www.iprhelphdesk.eu

For questions related to our training activities, please send us an email at:

training@iprhelphdesk.eu





Photo credits

istockphoto.com

- © istockphoto.com/maridav
- © istockphoto.com/Rtimages
- © istockphoto.com/Daniel Laflor
- © istockphoto.com/Bliznetsov
- © istockphoto.com/Zeffss1
- © istockphoto.com/jfelton
- © istockphoto.com/rzdeb
- © istockphoto.com/Agata Malchrowicz
- © istockphoto.com/Yuri_Arcurs
- © istockphoto.com/Dave White

Others

- © Scott Robertson
- © Microsoft Clip Art

Disclaimer/Legal Notice

The information and advice contained in this presentation is not intended to be comprehensive and attendants are advised to seek independent professional advice before acting upon them. The European IPR Helpdesk is not responsible for the consequences of errors or omissions herein enclosed. Re-use of information contained in this presentation for non-commercial purposes is authorised and free of charge, provided the source is acknowledged. The use of images – other than in the mere reproduction of this presentation – is prohibited. The European IPR Helpdesk is not responsible for any impact or adverse effects on third parties connected with the use or re-use made of the information contained in this presentation.

The European IPR Helpdesk is managed by the European Commission's Executive Agency for Small and Medium-sized Enterprises (EASME), with policy guidance provided by the European Commission's Enterprise and Industry Directorate - General. Even though this fact sheet has been developed with the financial support of the EU, the positions expressed are those of the authors and do not necessarily reflect the official opinion of EASME or the European Commission. Please see our full disclaimer at www.iprhelpdesk.eu.