



# Seminar on WIPO Services and Initiatives

Lisbon, Portugal  
May 06, 2014



# INTRODUCTION TO WIPO : DEVELOPMENT OF THE INTERNATIONAL LEGAL FRAMEWORK MAJOR IP ECONOMIC STUDIES



■ Speaker: Mr. Victor Vazquez Lopez, Section for Coordination of Developed Countries, Department for Transition and Developed Countries (TDC), WIPO

# BASICS FACTS ABOUT WIPO



- **WIPO's MISSION:** To promote the protection of IP rights worldwide and extend the benefits of the international IP system to all member states.
- **MEMBER STATES:** 186
- **OBSERVERS :** + 390
- **STAFF :** 950 FROM 101 COUNTRIES
- **ADMINISTERED TREATIES :** 26
- **MAIN ORGANS/BODIES :** GA, CC, WIPO CONFERENCE

# MILESTONES: 1883 - 2013

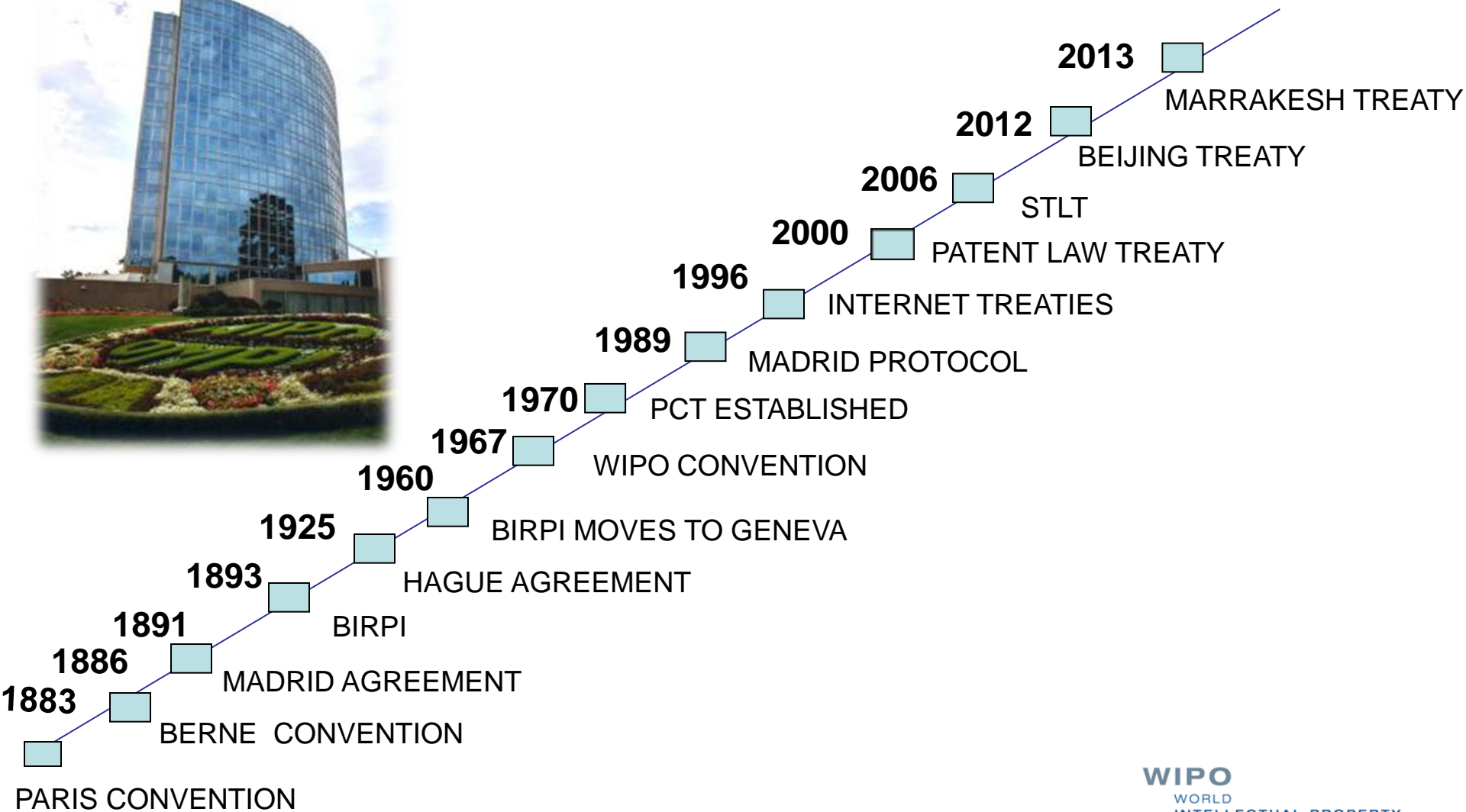

# INTELLECTUAL PROPERTY : OUTREACH

PUBLIC SECTOR & POLICY MAKERS



GENERAL PUBLIC & CIVIL SOCIETY

# WIPO's MAIN ACTIVITIES

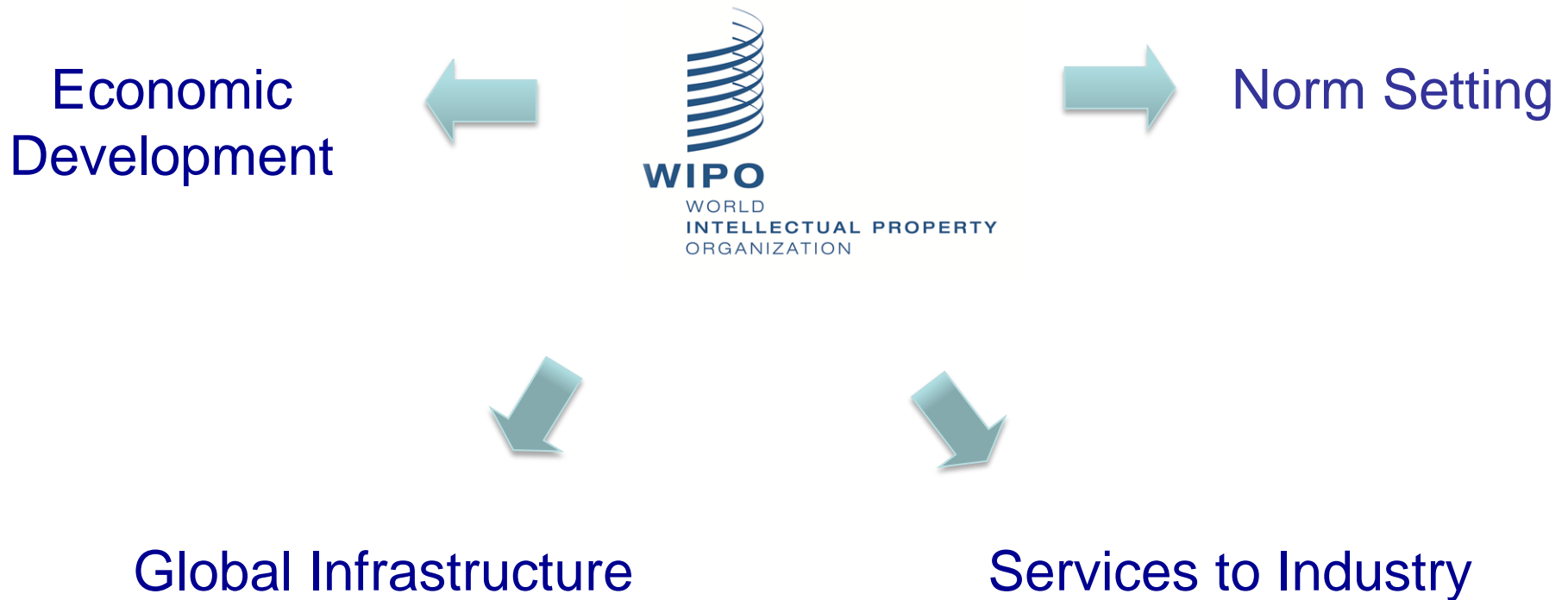

# WIPO ... PROVIDER OF PREMIER GLOBAL IP SERVICES

- Core income generating business areas:
  - Patent Cooperation Treaty (Patents)
  - Madrid System (Trademarks)
  - Hague System (Industrial Designs)
  - Lisbon System (Geographical Indications)
  - WIPO Arbitration and Mediation Center
  
- **AIM** : to be the first choice for users by continuing to offer cost-effective and value-added services

# WIPO's MAIN SOURCES OF REVENUE

**BUDGET 2014 – 2015 : CHF 713.3 MILLION**

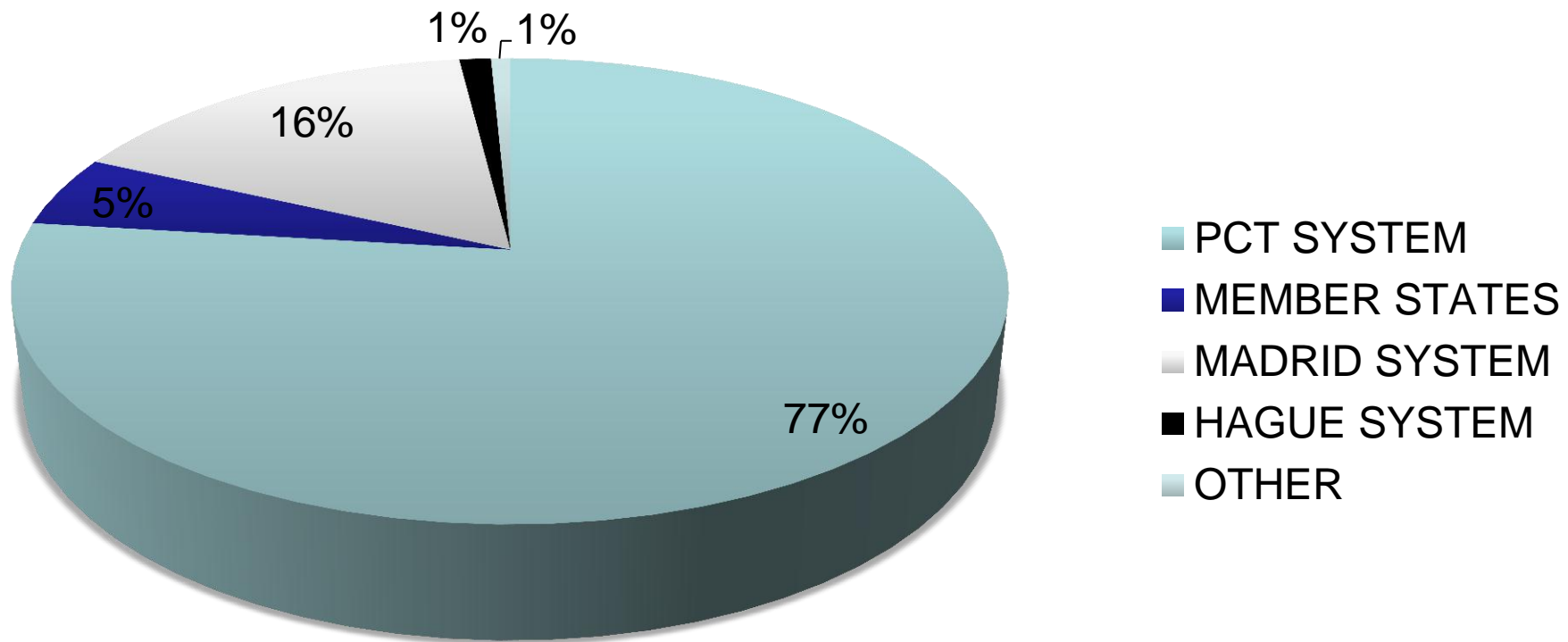



# GLOBAL IP INFRASTRUCTURE

- WIPO is coordinating with stakeholders to develop tools, services, platforms, standards, etc. that enable IP institutions to work :

- **EFFICIENTLY**

- **PROVIDE BETTER**

- **HIGH QUALITY SERVICES**

# GLOBAL IP INFRASTRUCTURE

## ■ INFRASTRUCTURE INCLUDES :

- *Databases* (PATENTSCOPE, Global Brand DB & access to aRDI and ASPI)
- Common platform for e-data *exchange* among IPOs (WIPO Case for Global Dossier, the Digital Access Service)
- Other platforms: WIPO Green; WIPO Research
- Tools (international *classifications* in TMs/design; IPC, Green inventory, Nice classification)
- *Standards* & technical agreements
- Services (International Cooperation for Patent Examination (ICE), Patent Information Services, including Legal Status of Patents)



# NORM SETTING



- AIM → Progressive development of international IP law for an IP system that is:
  - **balanced/responsive** to emerging needs
  - **effective** in encouraging innovation/creativity
  - **sufficiently flexible** to accommodate national policy objectives
  
- Topical issues reviewed/discussed in Standing Committees



# NORM SETTING



- WIPO treaties are often closely connected to infrastructure and services:
  - Treaties that provide legal support to international infrastructure and services: PCT, Madrid.
  - Business simplification treaties, which simplify the operation of national infrastructure and services: Singapore Treaty on the Law of Marks (2006), Patent Law Treaty (2000)

# STANDING COMMITTEES

- PATENTS (SCP)
- COPYRIGHT & RELATED RIGHTS (SCCR)
- TRADEMARKS, DESIGNS & GEOGRAPHICAL INDICATIONS (SCT)
- AIM :
  - Build consensus on topical issues
  - Take into account interests of all stakeholders for a balanced, reliable, efficient, user-friendly, cost-effective system.

N.B. Enforcement issues are discussed within the Advisory Committee on Enforcement (ACE)

# THE STANDING COMMITTEE ON LAW OF PATENTS



- Member States' Committee (IGOs and NGOs: observers)
- Established in 1998
- Forum to discuss issues, facilitate coordination and provide guidance concerning the *progressive international development of patent law*
- Forum that deals with a cluster of issues rather than each issue in isolation
- Since 2008, discussions on various issues identified by Member States

# THE STANDING COMMITTEE ON LAW OF PATENTS

## PART II

- Twentieth Session of the SCP took place from January 27 to 31, 2014
  
- **Quality of patents:** The Committee shared a general understanding that the proposal submitted with respect to the quality of patents did not lead to harmonization of substantive patent law and to automatic acceptance of work sharing products
  - A study will be prepared on inventive step containing the definition of the person skilled in the art, methodologies employed for evaluating an inventive step and the level of the inventive step
  
  - A study on sufficiency on of disclosure containing the enabling disclosure requirement, support requirement and written description requirement

# THE STANDING COMMITTEE ON LAW OF PATENTS

## PART III

- The Secretariat will prepare a document on how exceptions and limitations are implemented in Member States, without evaluating the effectiveness of those exceptions and limitations
- The Secretariat will collect more practical examples and experiences on patent-related and impediments to transfer of technology from members and observers of the Committee
- The Twenty-First session would be held from November 3 to 7, 2014





## NORM SETTING : INDUSTRIAL DESIGNS



### ■ THE STANDING COMMITTEE ON THE LAW OF TRADEMARKS, INDUSTRIAL DESIGNS AND GEOGRAPHICAL INDICATIONS (SCT)

- The SCT has substantially advanced work on the draft of a design law treaty
- The idea would be to have a design law treaty similar to the Patent Law Treaty and the Singapore Treaty
- A *business simplification treaty* will simplify and standardize the registration and ancillary procedures applied to industrial designs in different countries

# LATEST SCT SESSION (MARCH 2014)

- During the last session and with regard to technical assistance and capacity building, all delegations stated that progress was made.
  - Technical assistance and capacity building to help implementing the new treaty:
    1. For number of delegations technical assistance provisions have to be in the form of an article
    2. Other delegations either stated that they were flexible or that they would consider this option
  - Convening a diplomatic conference for the adoption of a Design Law Treaty
    1. Some delegations expressed the view that an agreement upon the existence of the article regarding technical assistance and capacity building had to be reached prior convening a diplomatic conference
    1. Other delegations stated that the treaty is mature enough to convene the Diplomatic Conference.
- The extraordinary session of the GA in May 2014 will decide whether to convene a Diplomatic Conference.

# BEYOND THE SCT

- *Beyond SCT*: Lisbon Union Assembly in September 2013 decided on the convening of a Diplomatic Conference for the adoption of a *Revised Lisbon Agreement* on Appellations of Origin and Geographical Indications in 2015.

# BEIJING TREATY ON AUDIOVISUAL PERFORMANCES JUNE, 26 2012





# BEIJING TREATY



- The treaty on audiovisual performances was adopted on June 2012. The treaty will enter into force with 30 ratifications.
- This treaty will strengthen the position of performers, giving them moral and economic rights for the international use of their performances.
- Countries becoming party will pay for the use of foreign audiovisual performances. Some or all of this money will be going to performers.
- « *The conclusion of the Beijing Treaty is an important milestone toward closing the gap in the international rights system for audiovisual performers* » WIPO Director General, Francis Gurry

# MARRAKESH TREATY TO FACILITATE ACCESS TO PUBLISHED WORKS FOR PERSONS WHO ARE BLIND, VISUALLY IMPAIRED OR OTHERWISE PRINT DISABLED



# MARRAKESH TREATY



- The Diplomatic Conference took place in Marrakesh from June 18 to 28, 2013 (600 negotiators from WIPO's 186 member states)
- There are more than 285 million blind and VIP- 90 % living in developing countries.
- Only 5 % of the books published are available in braille or other accessible formats.
- Requires contracting parties to adopt *limitations* for the benefit the people who are blind, visually impaired, and print disabled.
- It also provides for the *exchange* of accessible format works across borders.

# MAJOR ECONOMIC STUDIES ON IP



- A NEW WIPO UNIT – THE ECONOMICS AND STATISTICS DIVISION- REFLECTS THE GROWING CONSENSUS ON THE IMPORTANCE OF THE ECONOMIC DIMENSION OF IP.
- THE DIVISION APPLIES STATISTIC AND ECONOMIC ANALYSIS TO THE USE OF WIPO SERVICES.
- THIS NEW STRUCTURE ALSO IMPROVES WIPO ECONOMIC INSIGHT ON IP DEVELOPMENT.





# STRATEGIC REALIGNMENT WITHIN WIPO

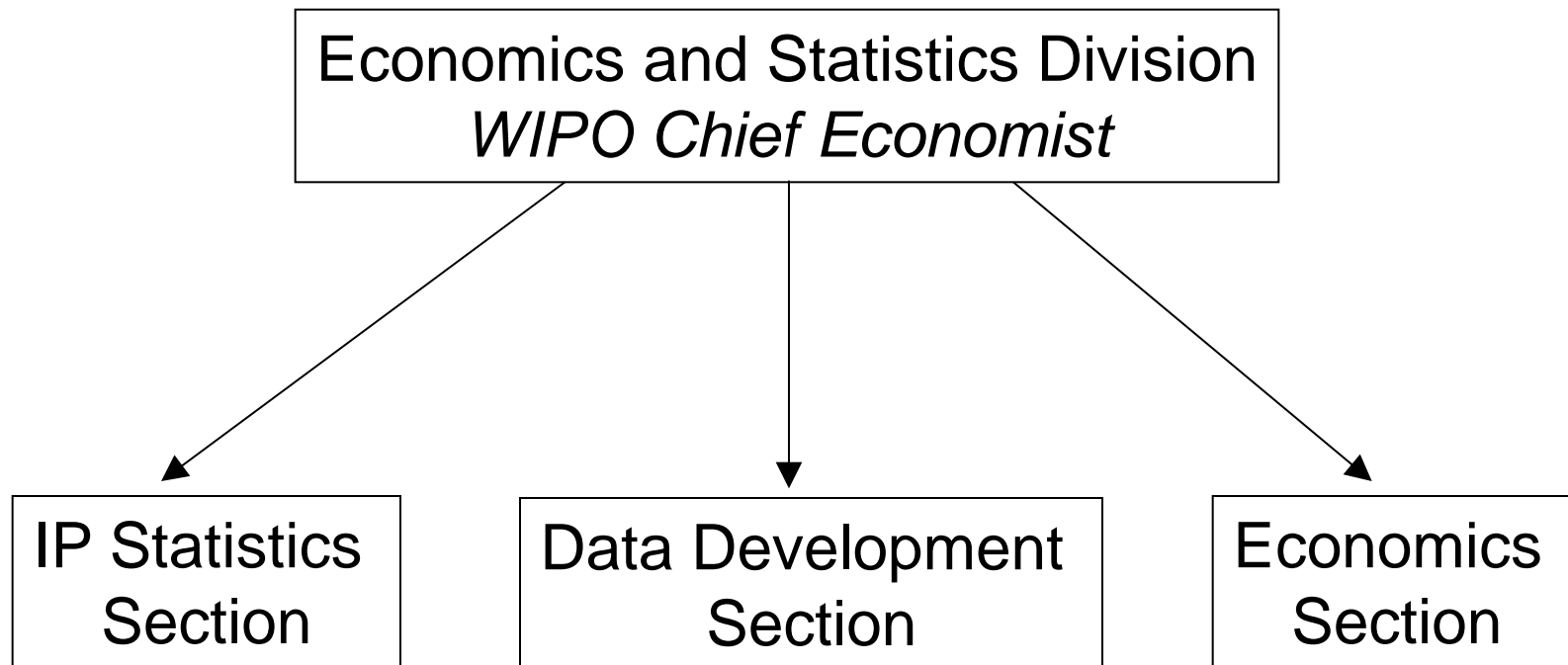

# TREND IN HAGUE FILINGS (DESIGNS)

Figure A.1.1 International applications

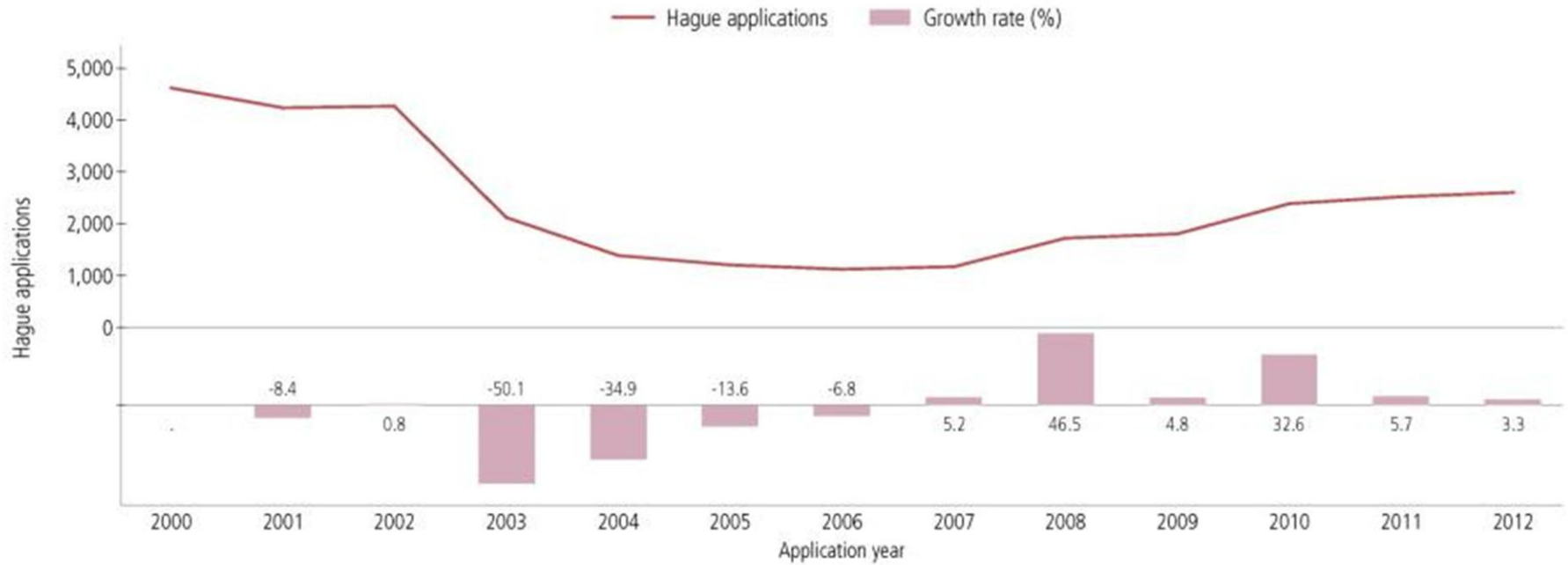

Source: WIPO Statistics Database, February 2013

# DEMAND FOR IP RIGHTS HAS GROWN

Patent applications at selected offices, 1900-2010

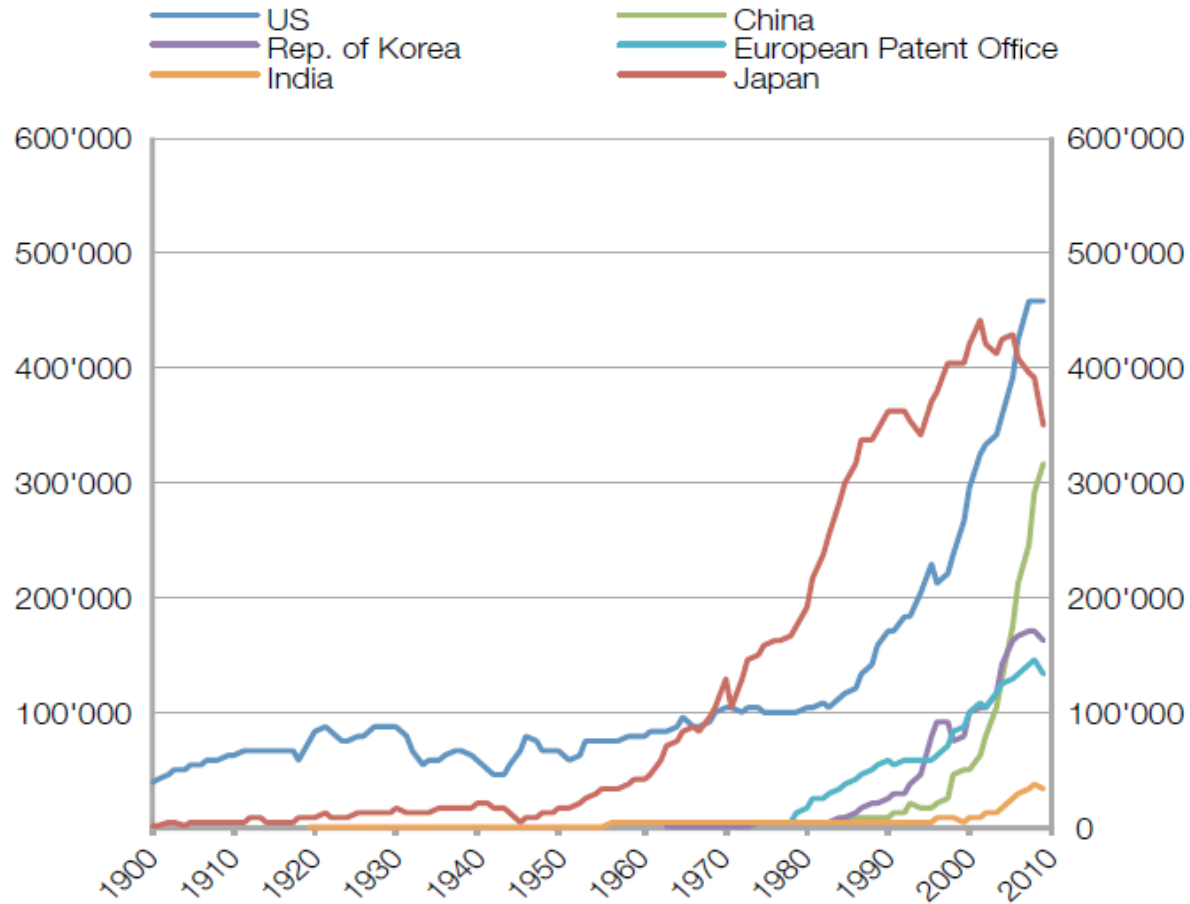

# MORE INVENTIONS AND GREATER INTERNATIONALIZATION

**Contribution of first and subsequent applications to total growth, in percent, 1995-2007**

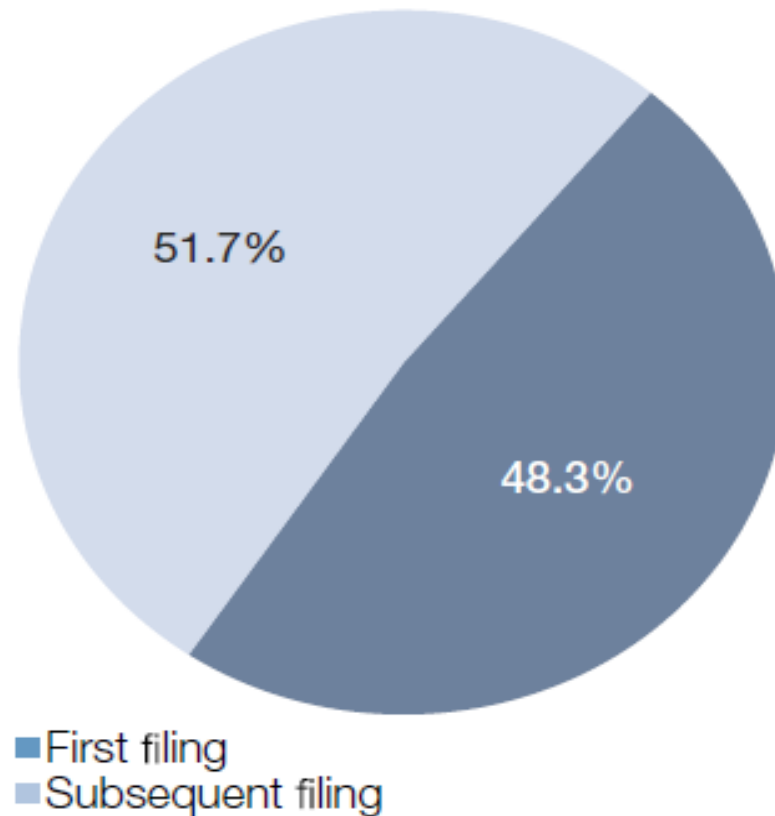

# STUDIES AND REPORTS

- **World Intellectual Property Indicators (WIPI):** This is our flagship IP statistics publication. It provides an overview of latest *trend* in IP filings and registrations covering more than 100 offices : <http://www.wipo.int/ipstats/en/wipi/index.html>
- **The PCT Yearly Review** provides an overview of the performance and development of the PCT system. It includes a comprehensive set of statistics for the latest available year See: <http://www.wipo.int/ipstats/en/statistics/pct/>
- **Madrid Yearly Review:** <http://www.wipo.int/ipstats/en/>
- **Hague Yearly Review:** <http://www.wipo.int/ipstats/en/>
- **The *WIPO IP Facts and Figures*** provides an overview of intellectual property (IP) activity based on the latest available year of statistics. It serves as a quick reference guide for statistics: <http://www.wipo.int/ipstats/en/>
- **WIPO IP Statistics Data Center** is an on-line service enabling access to WIPO's statistical data. Users can select from a wide range of indicators and view or download data according to their needs: <http://ipstatsdb.wipo.org/ipstatv2/ipstats/patentsSearch>

# STUDIES AND REPORTS

## II

- New report « Brands – Reputation and Image in the Global Marketplace»



The report looks at how branding behavior and trademark use have evolved in recent history, how they differ across countries, what is behind markets for brands, what lessons economic research holds for trademark policy and how branding strategies influence companies' innovation activities

For further information and the full report :

[http://www.wipo.int/econ\\_stat/en/economics/wipr](http://www.wipo.int/econ_stat/en/economics/wipr)



# THE GLOBAL INNOVATION INDEX 2013



- Annual publication that provides the latest trends in innovation activities across the world. It is co-published by INSEAD, Cornell Univ. and WIPO [http://www.wipo.int/econ\\_stat/en/economics/gii/index.html](http://www.wipo.int/econ_stat/en/economics/gii/index.html)
- Its results are **useful:**
  - To benchmark countries against their *peers*
  - To study countries profiles over *time*
  - Identify countries *strengths and weaknesses*

# THE GLOBAL INNOVATION INDEX 2013

- The framework is revised and adjusted every year in a transparent exercise
- This year, out of 84 indicators, 64 are identical to GII 2012, and a total of 20 indicators were modified
- 10 indicators were deleted/replaced
- 10 indicators underwent changes such as the computation methodology at the source, change of scaling factor, change of classification etc.
- The year per year comparison has to be carefully taken into consideration



# GLOBAL INNOVATION INDEX FRAMEWORK

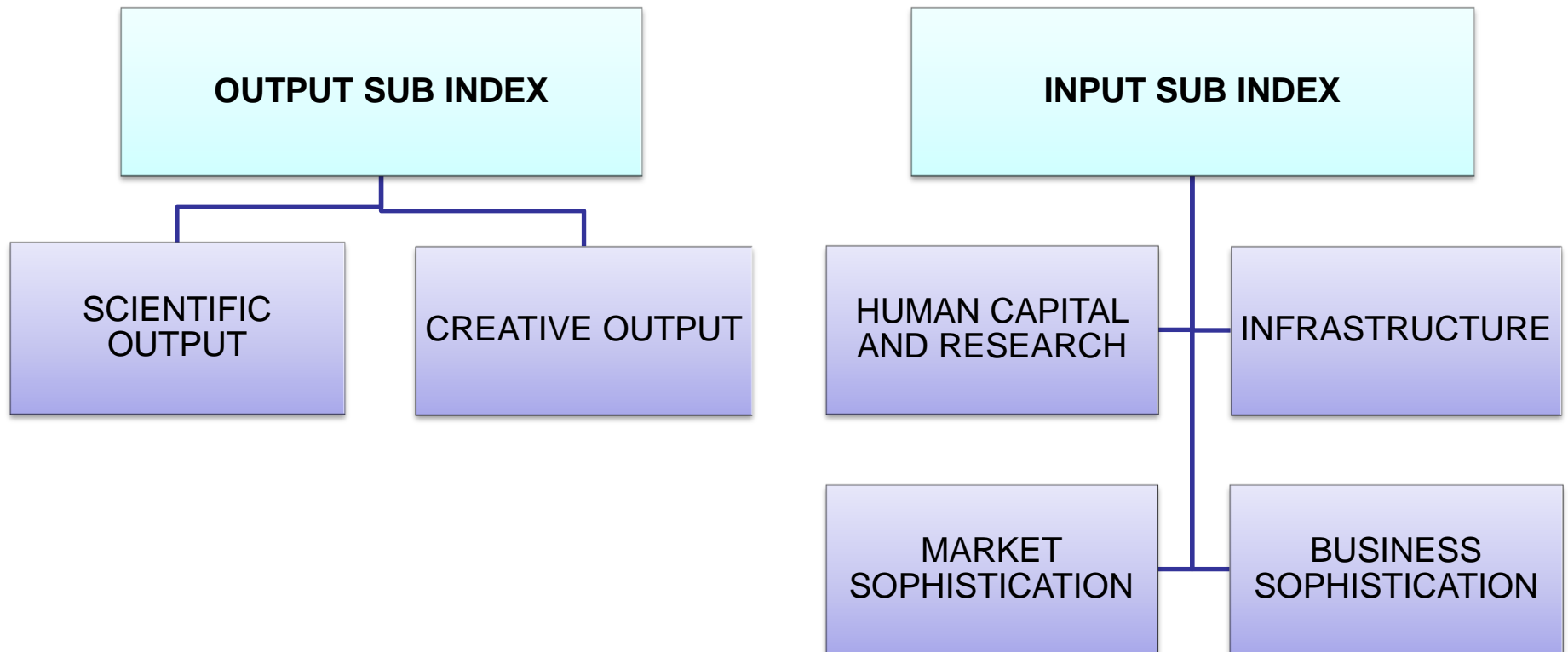

# PORTUGAL PROFILE



VODAPHONE HEADQUARTERS BY BARBOSA GUIMARÃES, PORTO, PORTUGAL

# THE GLOBAL INNOVATION INDEX

## RANKING 2012

- 1. SWITZERLAND
- 2. SWEDEN
- 3. SINGAPORE
- 34. PORTUGAL

## RANKING 2013

- 1. SWITZERLAND
- 2. SWEDEN
- 3. UNITED KINGDOM
- 35. PORTUGAL



# PORTUGAL STRENGTHS



■ Portugal's strengths are drawn mostly from Human Capital & Research :

➤ Portugal is ranked 22<sup>nd</sup> in Human Capital & Research

□ Portugal is ranked 19<sup>th</sup> within Education:

- Current expenditure on education, % GNI
- Public expenditure/pupil, % GDP/cap (ranked 11<sup>th</sup>)
- School life expectancy, years
- PISA scales in reading, maths & science
- Pupil-teacher ratio, secondary (ranked 4<sup>th</sup>)

# SOME DEFINITIONS

- **Current expenditure on education, % GNI:** *Current operating expenditures in education, including wages and salaries and excluding capital investments in buildings and equipment, as a percentage of gross national income (GNI)*
- **Public expenditure/pupil, % GDP/cap :** *Public expenditure includes government spending on educational institutions (both public and private), education administration, and subsidies for private entities*
- **School life expectancy, years:** *Total number of years of schooling that a child of a certain age can expect to receive in the future*



# PORTUGAL STRENGTHS



## ■ Portugal's strengths are also drawn from Market Sophistication

➤ Portugal is ranked 25<sup>th</sup> with regard to the Market Sophistication indices

□ Portugal is 13<sup>th</sup> with regard to Credit indices:

- Ease of getting credit
- Domestic credit to private sector, % GDP (ranked 8<sup>th</sup>)
- Microfinance gross loans, % GDP

# PORTUGAL'S EVOLUTION WITH RESPECT TO IP FILINGS AND ECONOMIC GROWTH FROM 1998 TO 2012

- The graphic shows a recent peak (2002) in industrial design's filling, which is still strongly growing today. This is a sign of the strength of industrial designs in Portugal.
- The patents and trademarks filings are also present. This steady growth is a sign of Portugal's reliance on IP for economic development.

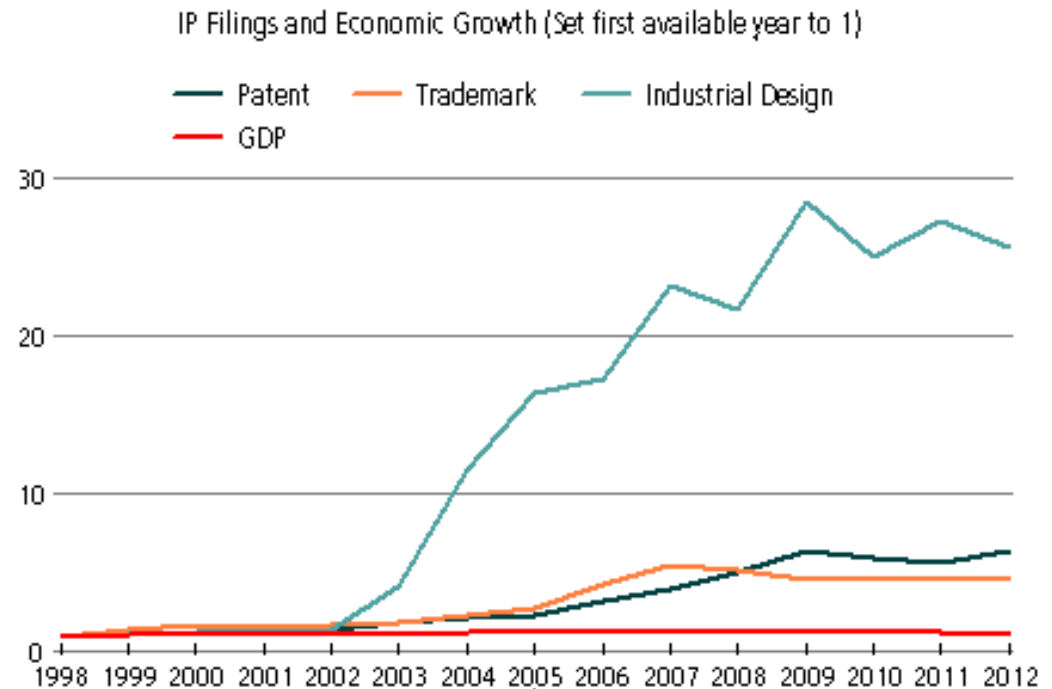

Source: WIPO statistics database; last updated: 03/2014

# PATENT APPLICATION BY TOP FIELDS OF TECHNOLOGY (1998-2012)

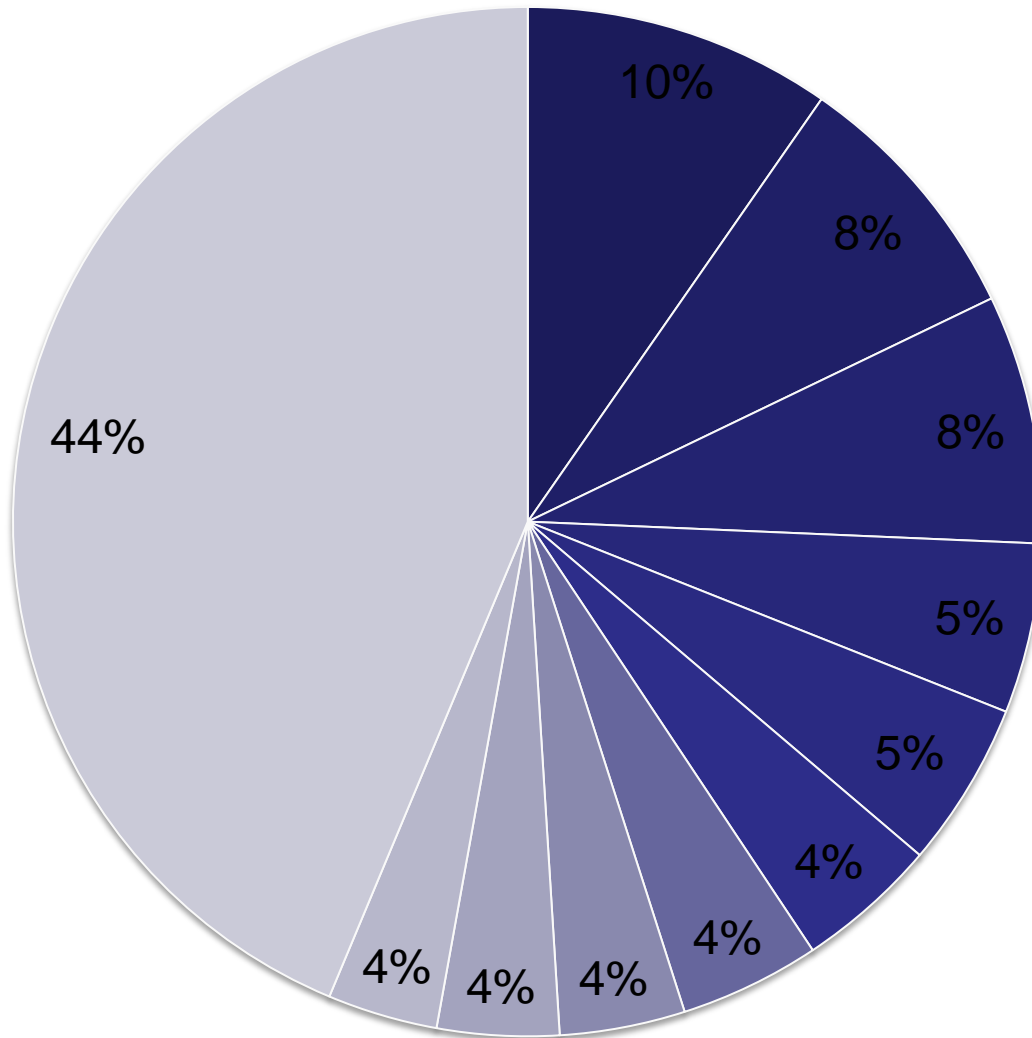

- Pharmaceuticals (10%)
- Civil engineering (8%)
- Organic fine chemistry (8%)
- Biotechnology (5%)
- Other special machines (5%)
- Furniture, games (4%)
- Transport (4%)
- Medical technology (4%)
- Chemical engineering (4%)
- Measurement (4%)
- Others (44%)



# INTERNATIONAL APPLICATIONS VIA WIPO ADMINISTERED TREATIES

## PORTUGAL

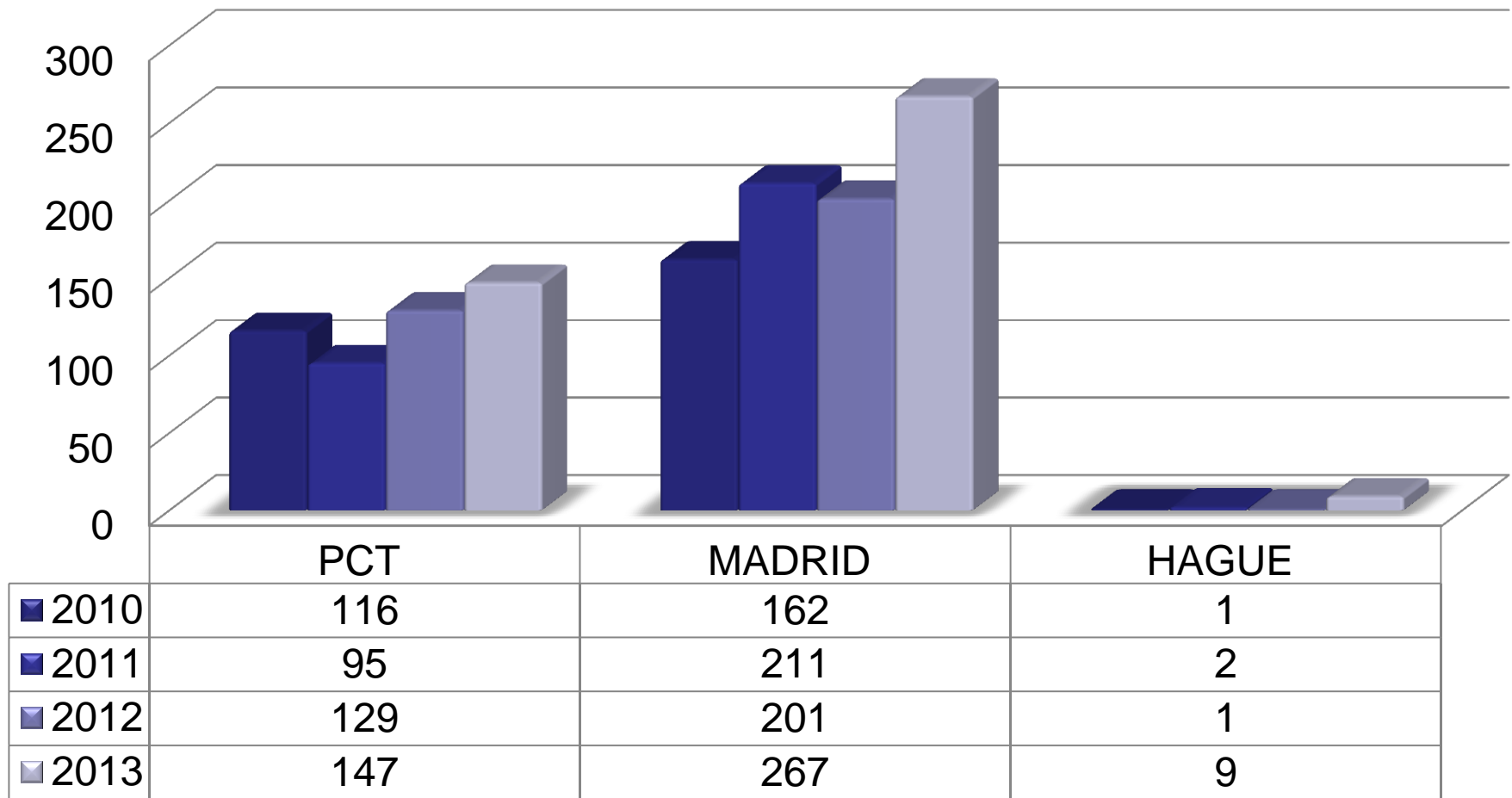



**THANK YOU!**

**\*\*\*\*\***

Mr. Victor Vazquez Lopez

Head

Section for the Coordination of Developed Countries (SCDC)

Department for Transition and Developed Countries(TDC)

World Intellectual Property Organization (WIPO)

Email: [Victor.Vazquez-lopez@wipo.int](mailto:Victor.Vazquez-lopez@wipo.int)

# PATENT COOPERATION TREATY (PCT) INTRODUCTION AND FUTURE DEVELOPMENTS



Speaker: Mr. Claus Matthes, Director, PCT Business Development Division, WIPO

# USING THE TRADITIONAL PATENT SYSTEM TO SEEK MULTINATIONAL PATENT PROTECTION

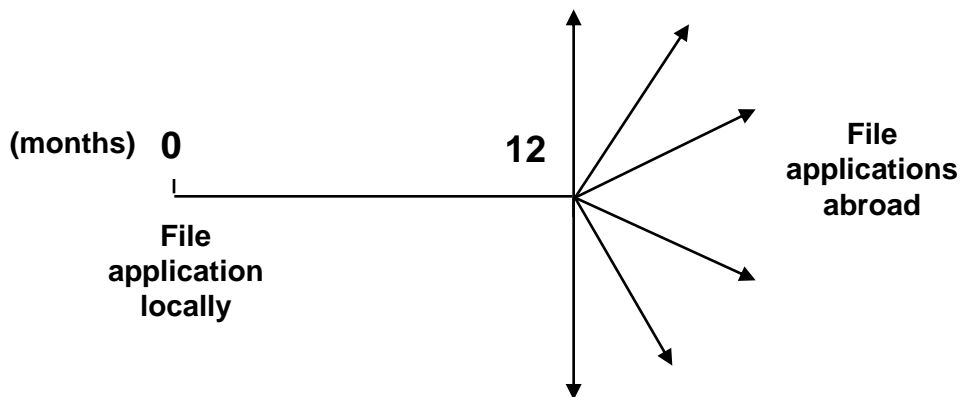

Local patent application followed within 12 months by multiple foreign applications claiming priority under Paris Convention:

- - multiple formality requirements
- - multiple searches
- - multiple publications
- - multiple examinations and prosecutions of applications
- - translations and national fees required at 12 months

Some rationalization because of regional arrangements:  
ARIPO, EAPO, EPO, OAPI

# THE PCT – 1970



- Basic idea: simplify the procedure for obtaining patent protection in many countries, making it more efficient and economical for:
  - users of the patent system: makes available a *filing tool for applicants* for foreign patent filings; and
  - patent offices: makes available a *tool for effective processing of patent applications by offices* of PCT Member States willing to exploit work done by others

# PCT BASICS



## ■ Filing Tool for applicants:

- Only one application filed, containing, by default, the designation of all States (for every kind of protection available) and usual priority claim(s)
- Has the effect of a regular national filing (including establishment of a priority date) in each designated State: the international filing date is the filing date in each designated State
- Filed in one language
- Filed with one Office
- One set of formality requirements
- Delays national processing until 30 months from priority date
- International reports improve basis for decision making

# PCT BASICS



## ■ Work sharing tool for Offices:

- Central formality checking
- Central international publication
- International search report (ISR)
- International Preliminary Reports on Patentability (preliminary, non-binding opinion on novelty, inventive step (non-obviousness) and industrial applicability)
  - ❖ Chapter I
  - ❖ Chapter II

# TRADITIONAL PATENT SYSTEM VS. PCT SYSTEM

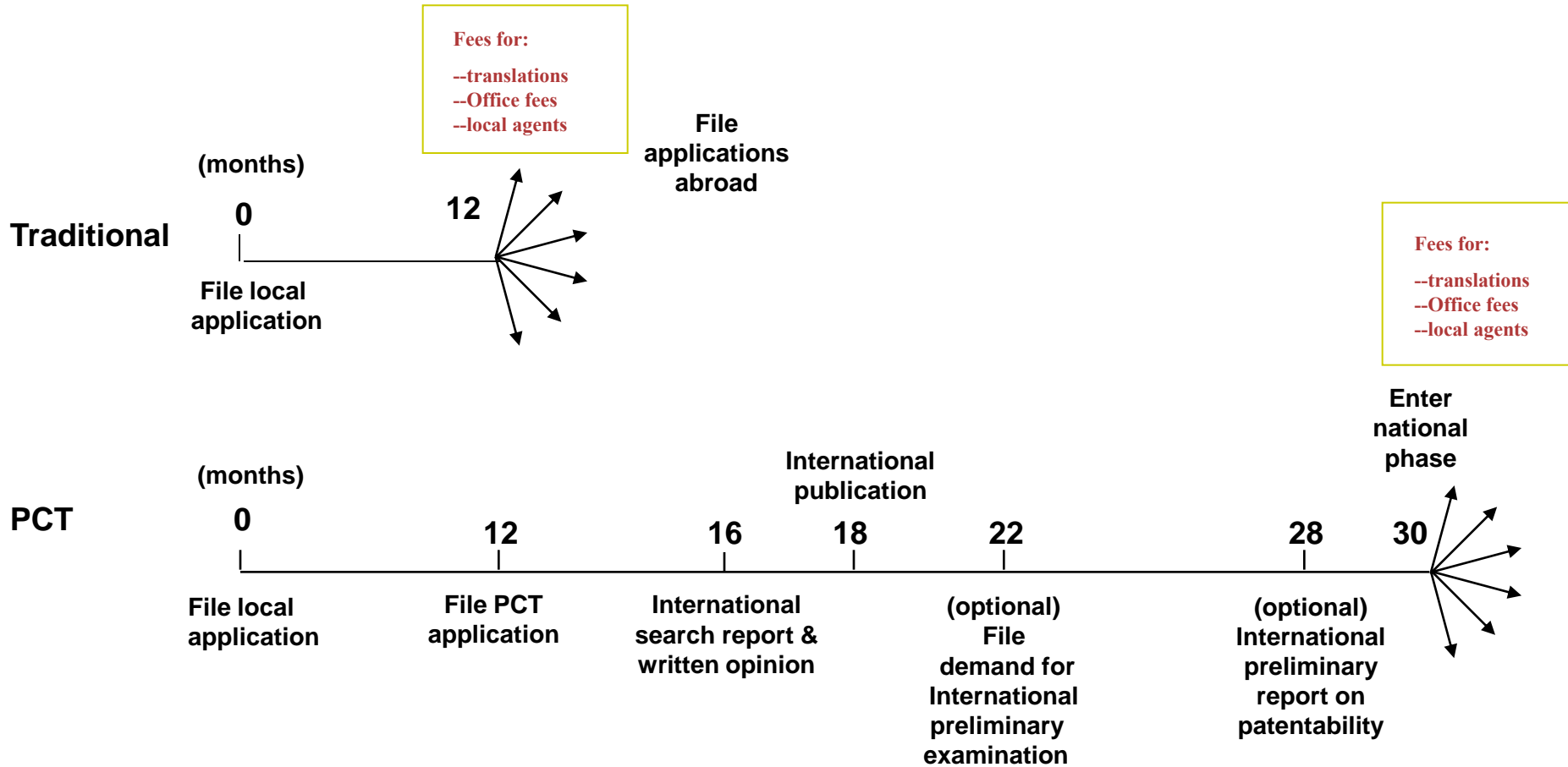



# THE PCT SYSTEM

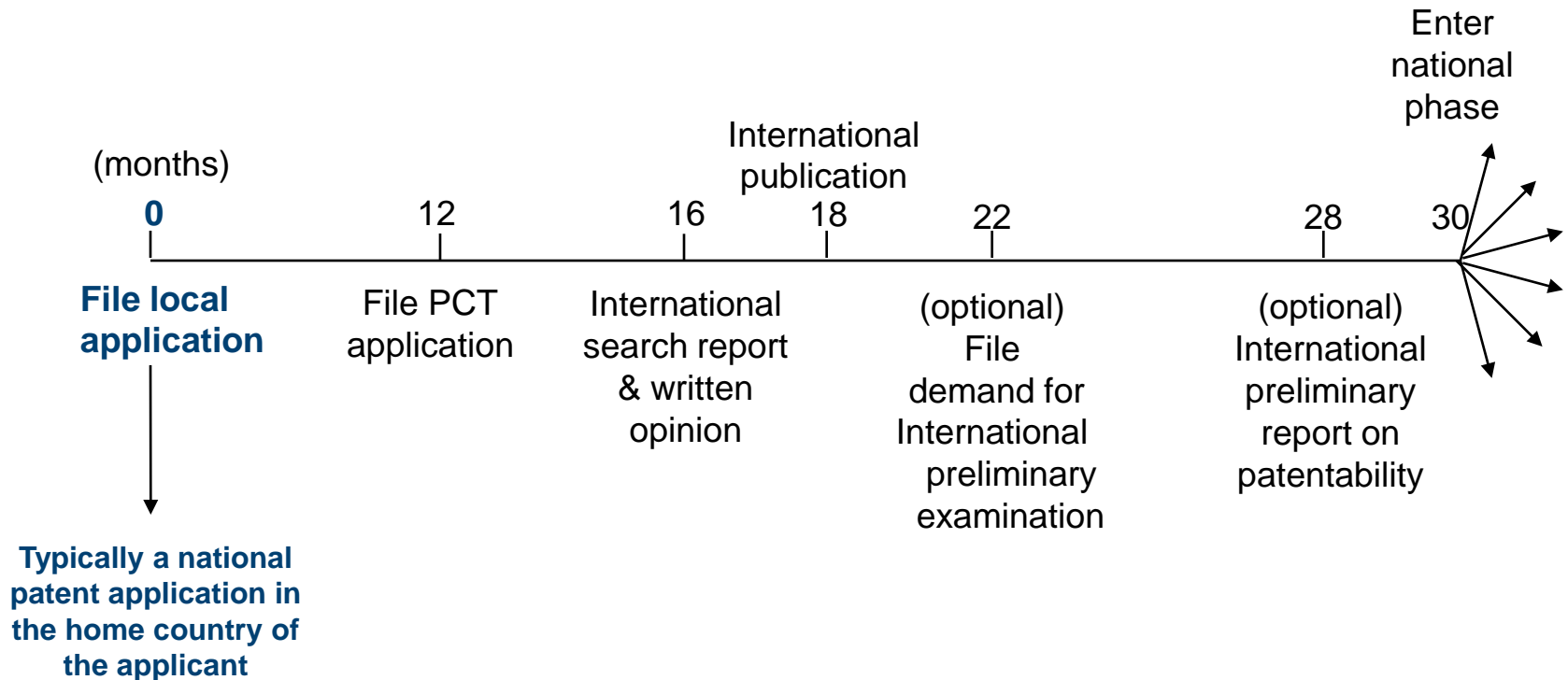

# THE PCT SYSTEM

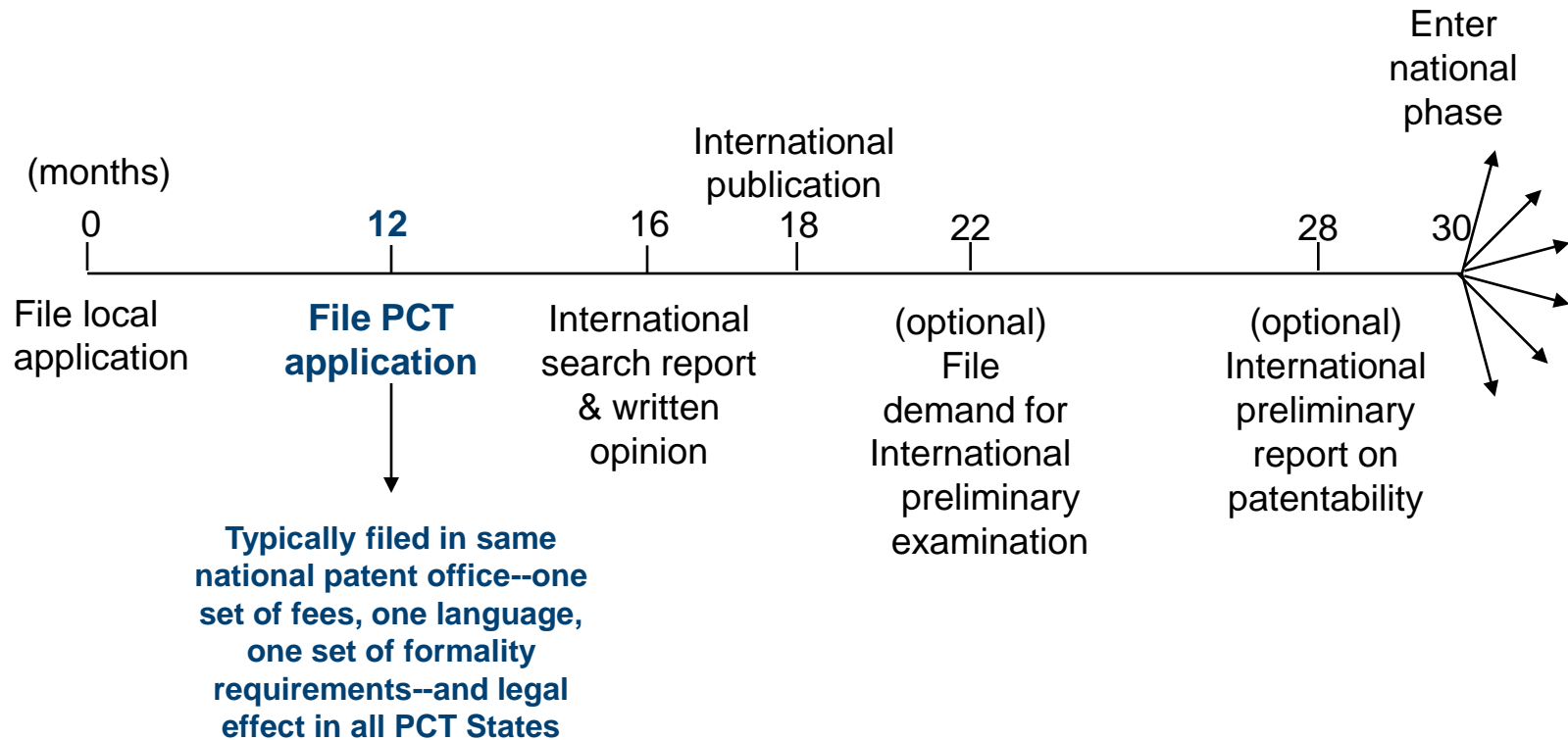

# THE PCT SYSTEM

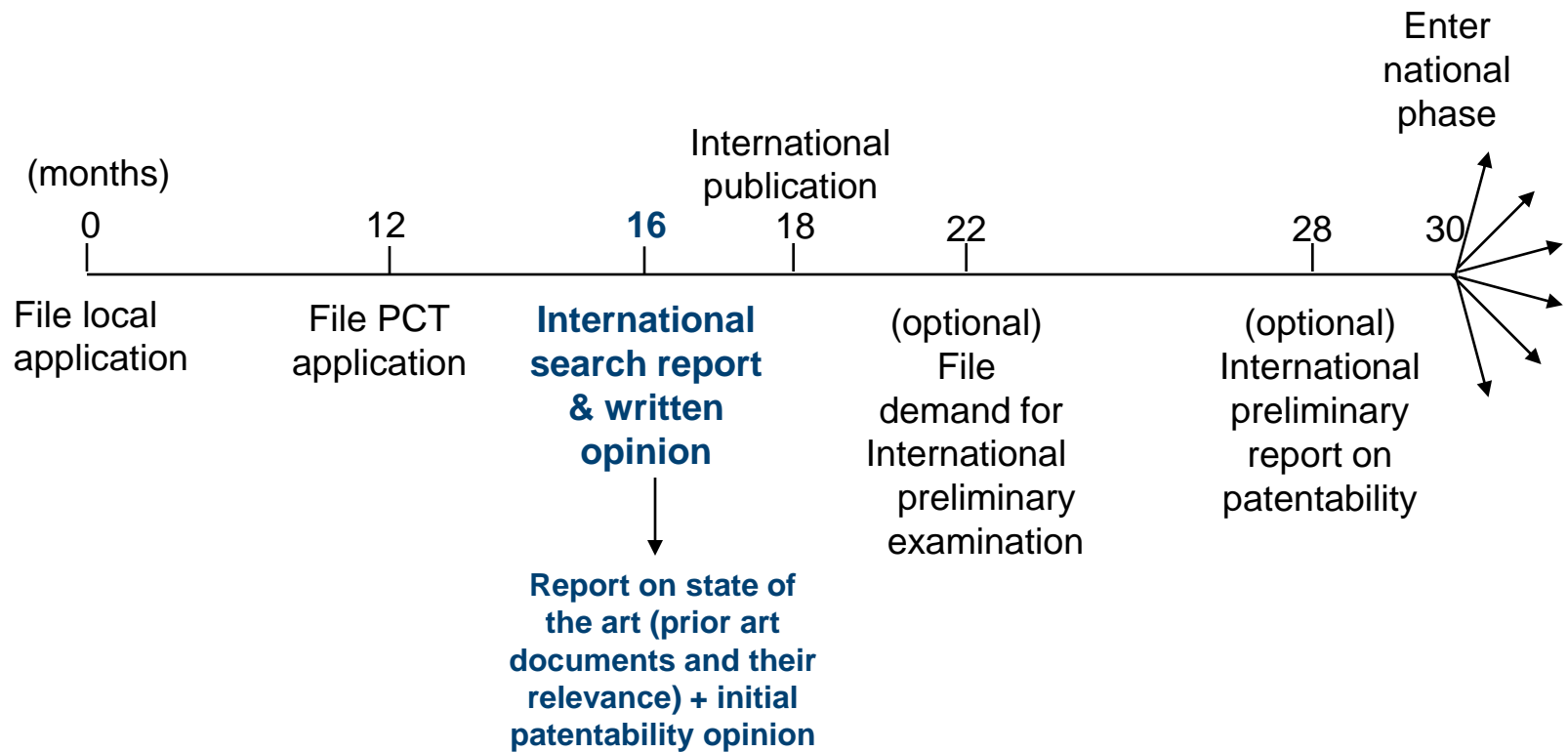

# PCT INTERNATIONAL SEARCHING AUTHORITIES

The ISAs are the following 19 offices:

- Australia
- Austria
- Brazil
- Canada
- China
- Chile (not yet operating)
- Egypt
- Finland
- India
- Israel
- Japan
- Republic of Korea
- Russian Federation
- Spain
- Sweden
- Ukraine (not yet operating)
- United States of America
- European Patent Office
- Nordic Patent Institute

# PRIOR ART FOR INTERNATIONAL SEARCH

- Prior art:
  - everything which has been made available to the public,
  - anywhere in the world,
  - by means of written disclosure,
  - which is capable of being of assistance in determining that the claimed invention is or is not new and that it does or does not involve an inventive step,
  - provided the making available to the public occurred prior to the international filing date.
  
- PCT Minimum Documentation (Rule 34)

# EXAMPLE: PCT INTERNATIONAL SEARCH REPORT

C. DOCUMENTS CONSIDERED TO BE RELEVANT		
Category*	Citation of document, with indication, where appropriate, of the relevant passages	Relevant to claim No.
X	JP 50-14535 B (NCR CORPORATION) 28 May 1975 (28.05.75), column 4, lines 3 to 27	7-9, 11
X	GB 392415 A (JONES) 18 May 1933 (18.05.33) Fig. 1	1-3
Y	page 3, lines 5-7	4, 10
A	Fig. 5, support 36	11-12
X	GB 2174500 A (STC) 5 November 1986 (05.11.86) page 1, lines 5-15, 22-34, 46-80; Fig. 1	1-3
Y		4
A	US 4322752 A (BIXTY) 30 March 1982 (30.03.82) claim 1	1
A	GREEN, J.P. Integrated Circuit and Electronic Compass, IBM Technical Disclosure Bulletin, October 1975, Vol. 17, No. 6, pages 1344 and 1345	1-5

**Symbols indicating which aspect of patentability the document cited is relevant to (for example, novelty, inventive step, etc.)**

**Documents relevant to whether or not your invention may be patentable**

**The claim numbers in your application to which the document is relevant**

WRITTEN OPINION OF THE  
INTERNATIONAL SEARCHING AUTHORITY

International application No.

Box No. V Reasoned statement under Rule 43bis.1(a)(i) with regard to novelty, inventive step or industrial applicability; citations and explanations supporting such statement

1. Statement

Novelty (N)	Claims	<u>Claim(s) 3-15</u>	YES
	Claims	<u>Claim(s) 16</u>	NO
Inventive step (IS)	Claims	<u>Claim(s) 8, 10-12</u>	YES
	Claims	<u>Claim(s) 3-7, 9, 14-16</u>	NO
Industrial applicability (IA)	Claims	<u>Claim(s) 3-16</u>	YES
	Claims	_____	NO

2. Citations and explanations:

**INDEPENDENT CLAIM 3**

Document US-A-5 332 238, which is considered to represent the most relevant state of the art, discloses (cf. relevant passages indicated in the ISR) a device from which the subject-matter of **INDEPENDENT CLAIM 3**

Document US-A-5 332 238, which is considered to represent the most relevant state of the art,

**Reasoning supporting the assessment**

**Patentability assessment of claims**

# THE PCT SYSTEM





# THE PCT SYSTEM

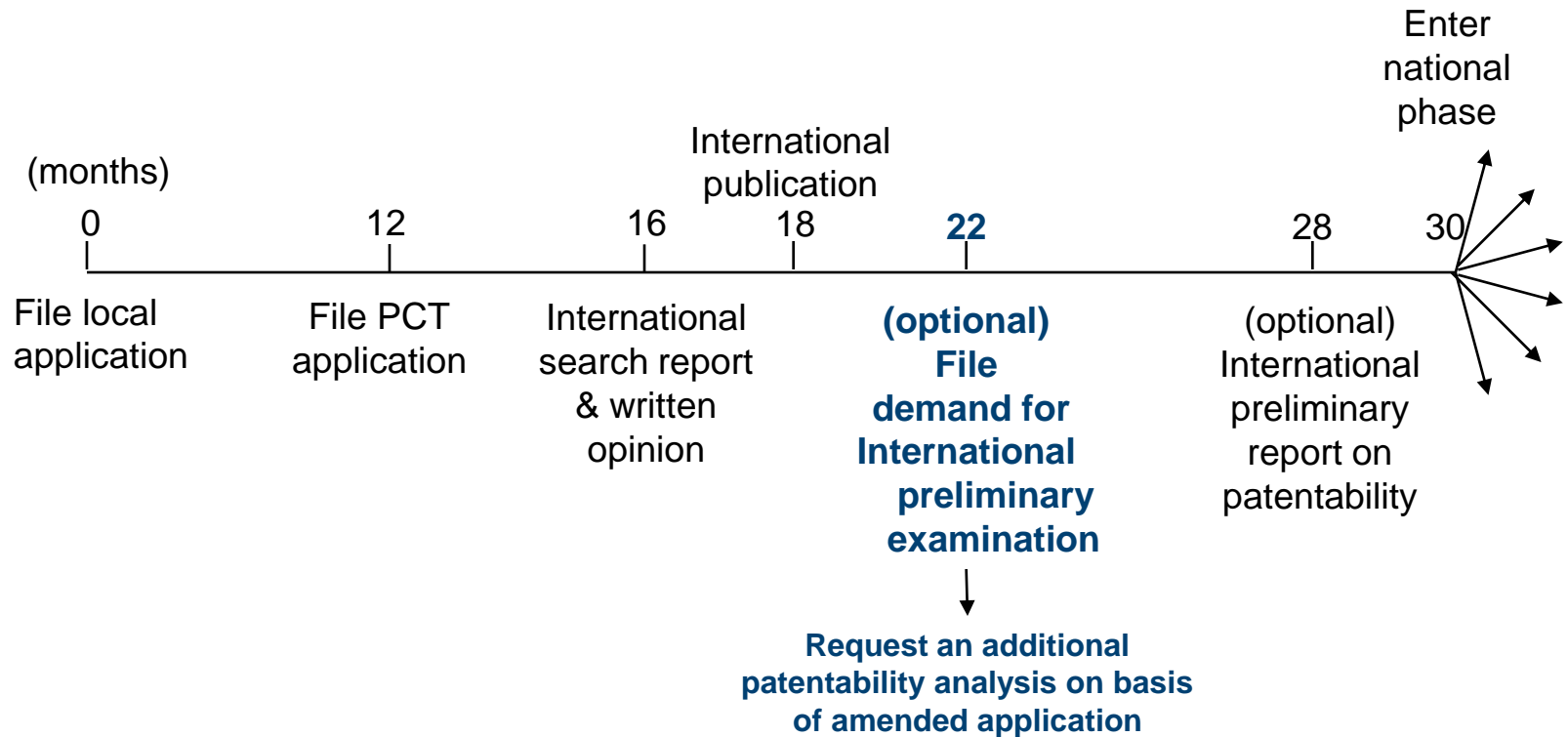

# THE PCT SYSTEM

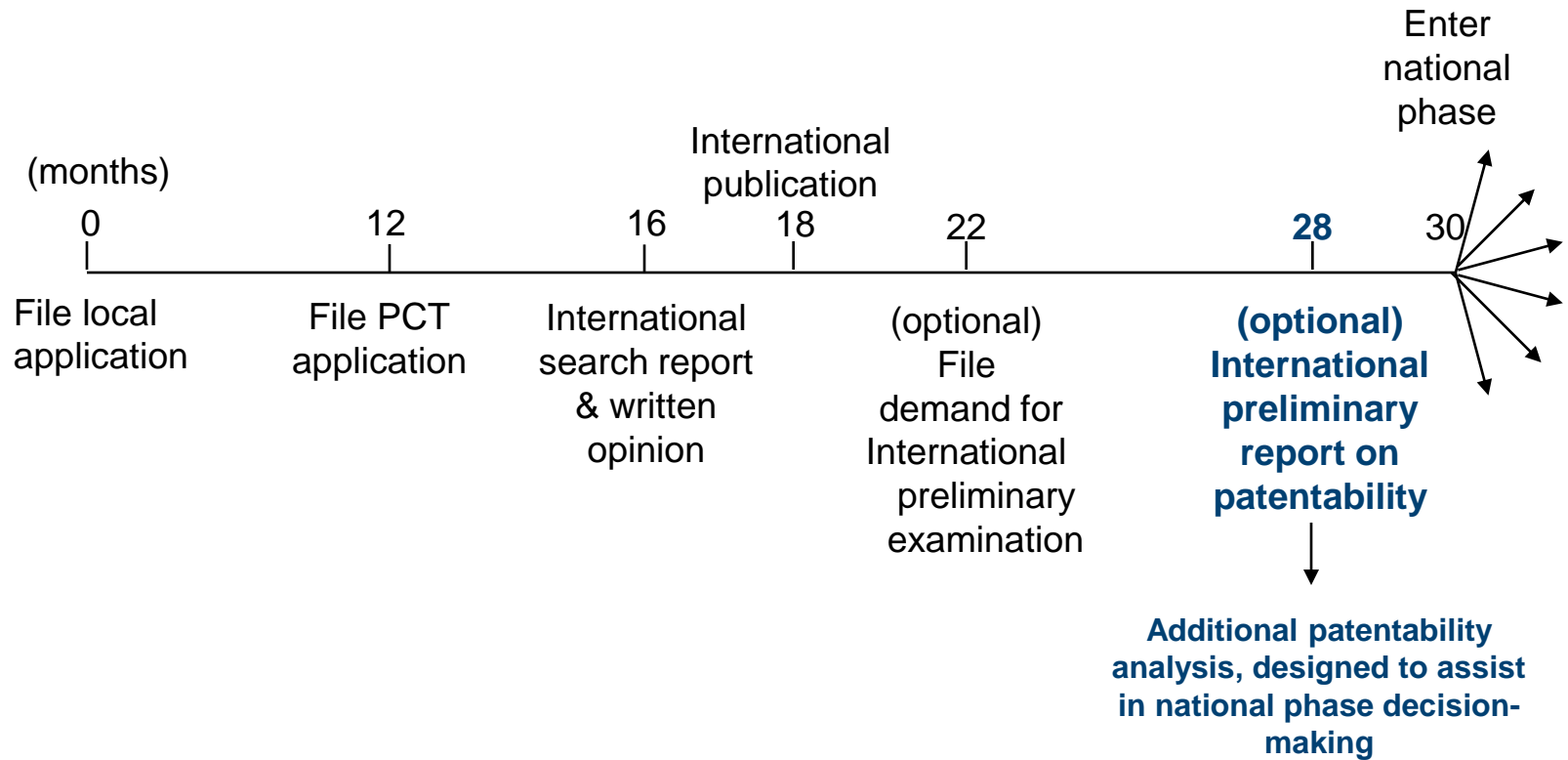

# THE PCT SYSTEM

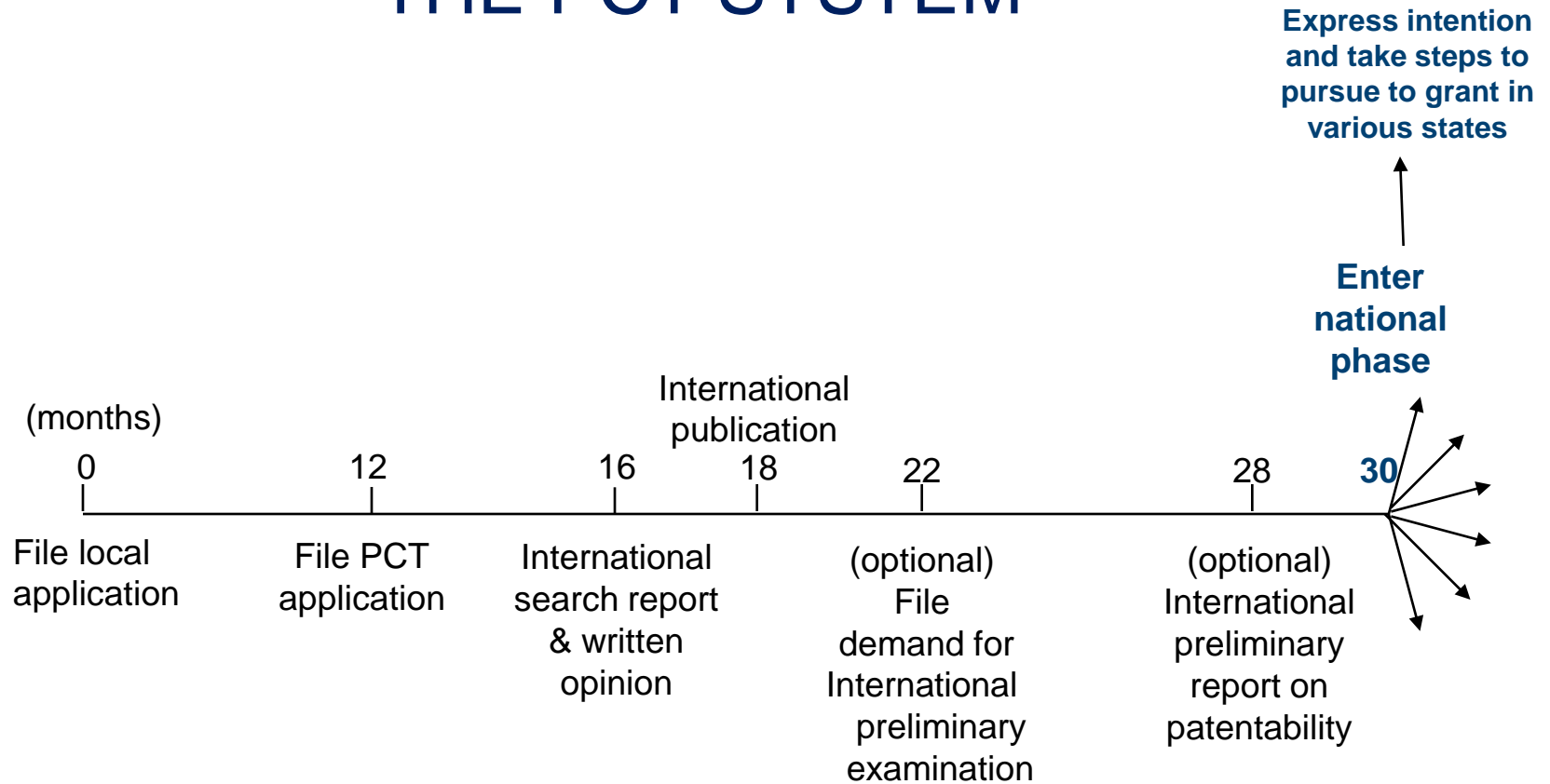

# THE PCT



## Your PCT Tool

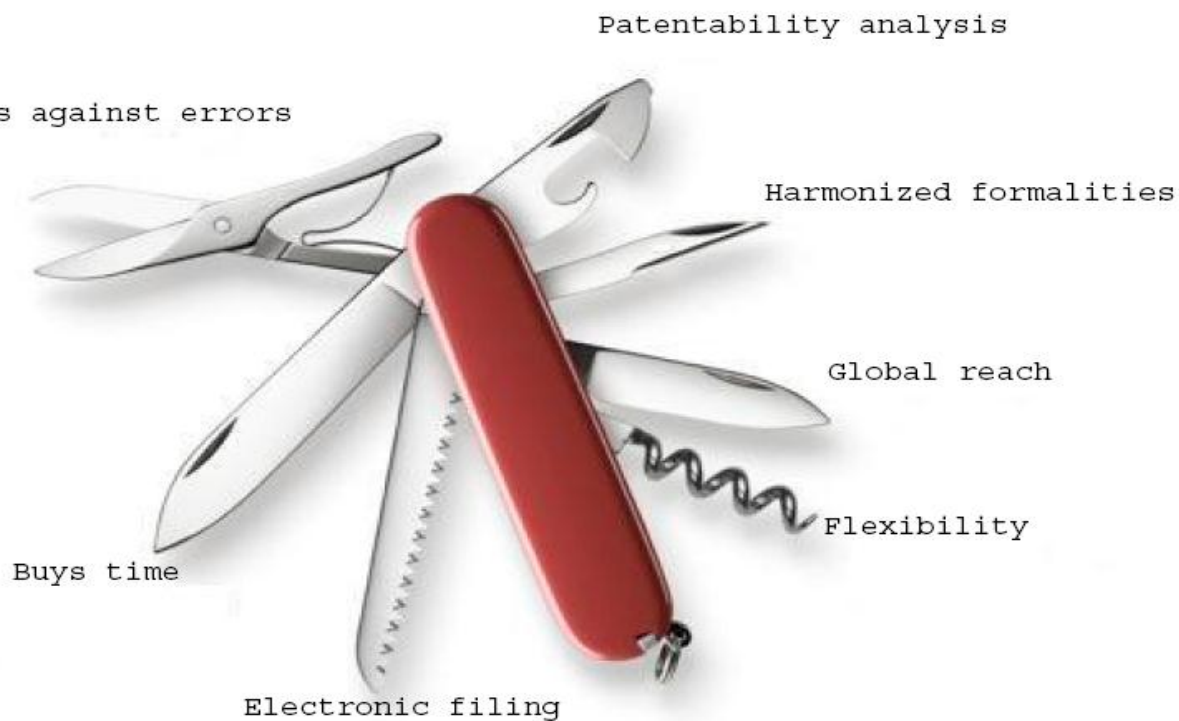

# THE PCT IN 1978

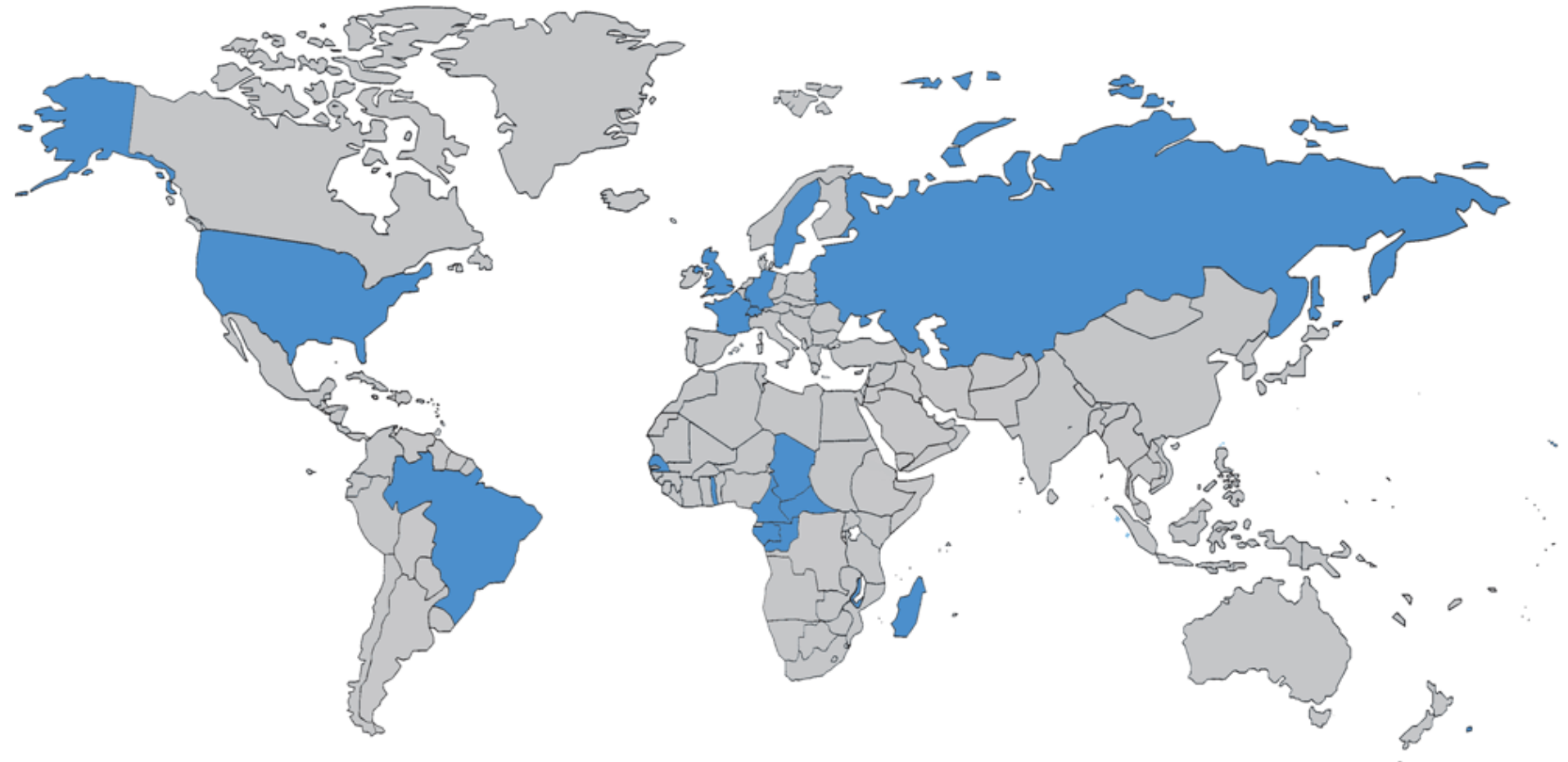

# PCT COVERAGE TODAY

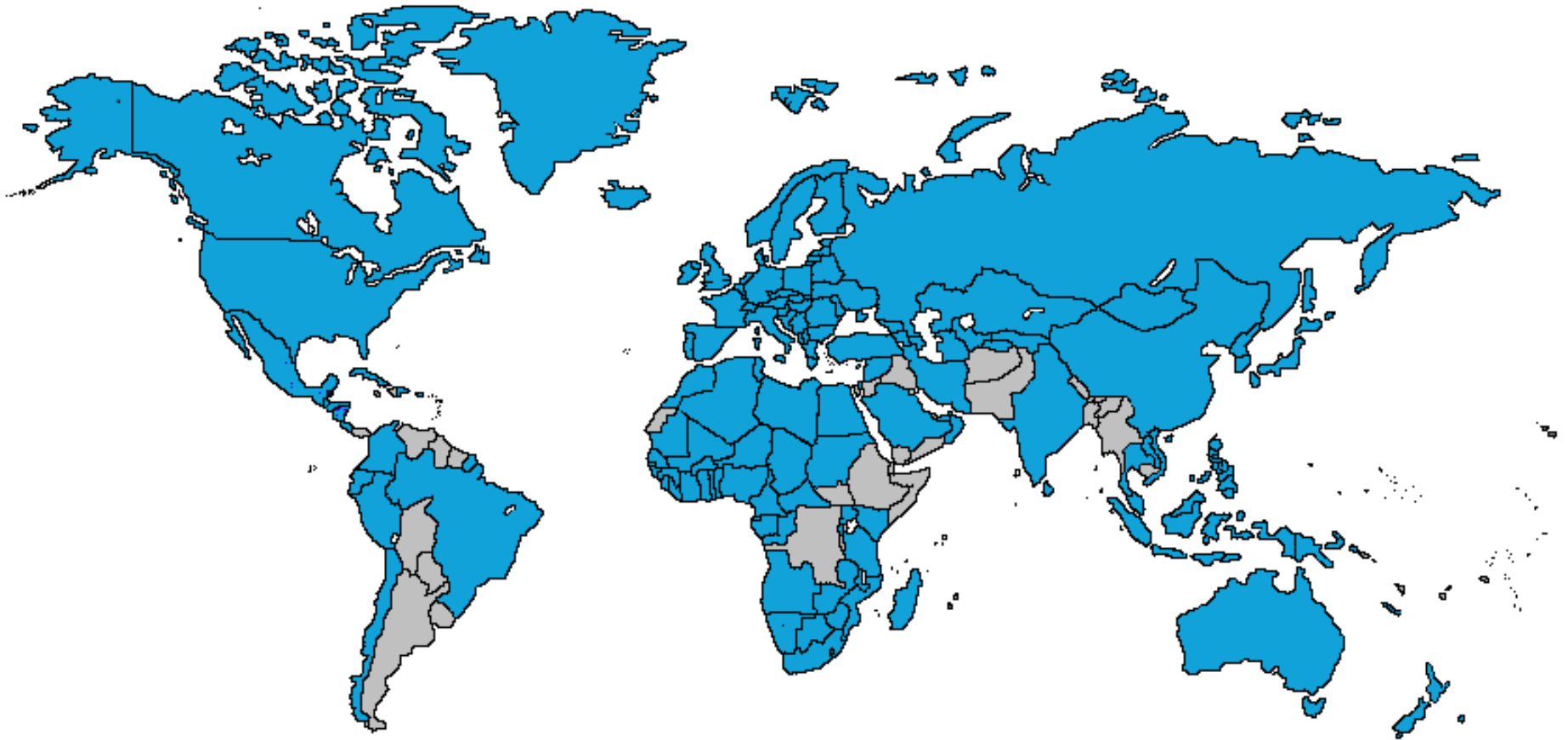

# 148 PCT STATES

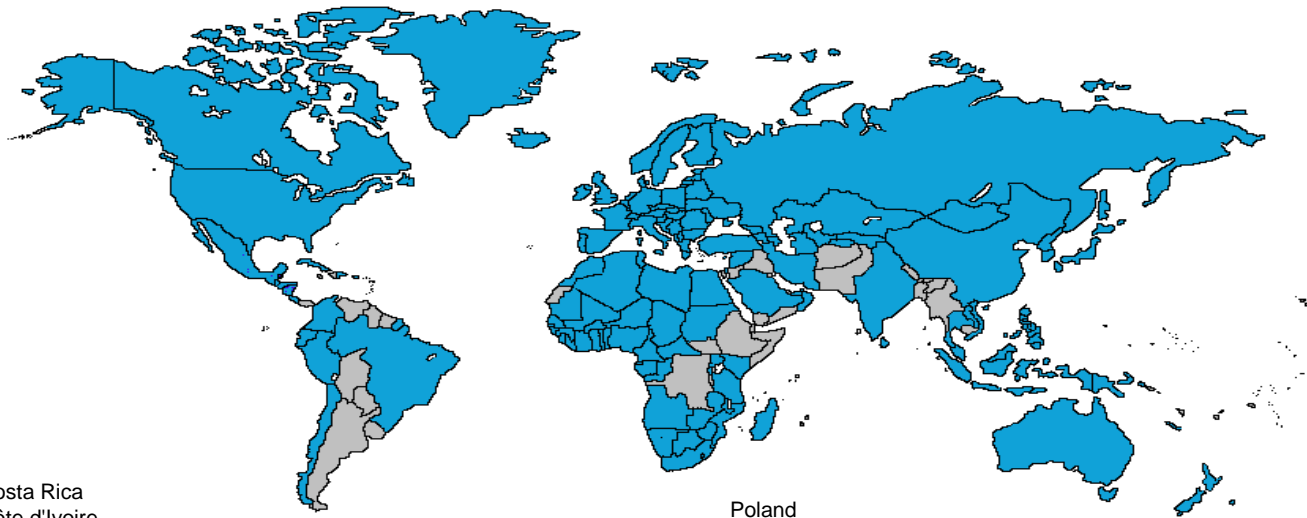

Albania  
Algeria  
Angola  
Antigua and Barbuda  
Armenia  
Australia  
Austria  
Azerbaijan  
Bahrain  
Barbados  
Belarus  
Belgium  
Belize  
Benin  
Bosnia and Herzegovina  
Botswana  
Brazil  
Brunei Darussalam  
Bulgaria  
Burkina Faso  
Cameroon  
Canada  
Central African Republic  
Chad  
Chile  
China  
Colombia  
Comoros  
Congo

Costa Rica  
Côte d'Ivoire  
Croatia  
Cuba  
Cyprus  
Czech Republic  
Democratic People's  
Republic of Korea  
Denmark  
Dominica  
Dominican Republic  
Ecuador  
Egypt  
El Salvador  
Equatorial Guinea  
Estonia  
Finland  
France  
Gabon  
Gambia  
Georgia  
Germany  
Ghana  
Greece  
Grenada  
Guatemala  
Guinea

Guinea-Bissau  
Honduras  
Hungary  
Iceland  
India  
Indonesia  
**Iran (Islamic Republic of)**  
**(4 Oct. 2013)**  
Ireland  
Israel  
Italy  
Japan  
Kazakhstan  
Kenya  
Kyrgyzstan  
Lao People's Dem Rep.  
Latvia  
Lesotho  
Liberia  
Libyan Arab Jamahiriya  
Liechtenstein  
Lithuania  
Luxembourg  
Madagascar

Malawi  
Malaysia  
Mali  
Malta  
Mauritania  
Mexico  
Monaco  
Mongolia  
Montenegro  
Morocco  
Mozambique  
Namibia  
Netherlands  
New Zealand  
Nicaragua  
Niger  
Nigeria  
Norway  
Oman  
Panama  
Papua New Guinea  
Peru  
Philippines

Poland  
Portugal  
Qatar  
Republic of Korea  
Republic of Moldova  
Romania  
Rwanda  
Russian Federation  
Saint Lucia  
Saint Vincent and  
the Grenadines  
San Marino  
Sao Tomé e Príncipe  
**Saudi Arabia (3 Aug. 2013)**  
Senegal  
Serbia  
Seychelles  
Sierra Leone  
Singapore  
Slovakia  
Slovenia  
South Africa  
Spain  
Sri Lanka  
Sudan  
Swaziland

St. Kitts and Nevis  
Sweden  
Switzerland  
Syrian Arab Republic  
Tajikistan  
Thailand  
The former Yugoslav  
Republic of Macedonia  
Togo  
Trinidad and Tobago  
Tunisia  
Turkey  
Turkmenistan  
Uganda  
Ukraine  
United Arab Emirates  
United Kingdom  
United Republic of Tanzania  
United States of America  
Uzbekistan  
Viet Nam  
Zambia  
Zimbabwe

# COUNTRIES NOT YET IN PCT

Afghanistan

Andorra

Argentina

Bahamas

Bangladesh

Bhutan

Bolivia

Burundi

Cambodia

Cape Verde

Democratic Republic of

Congo

Djibouti

Eritrea

Ethiopia

Fiji

Guyana

Haiti

Iraq

Jamaica

Jordan

Kiribati

Kuwait

Lebanon

Maldives

Marshall Islands

Mauritius

Micronesia

Myanmar

Nauru

Nepal

Pakistan

Palau

Paraguay

Samoa

Solomon Islands

Somalia

South Sudan

Suriname

Timor-Leste

Tonga

Tuvalu

Uruguay

Vanuatu

Venezuela

Yemen

(45)



# PCT APPLICATIONS

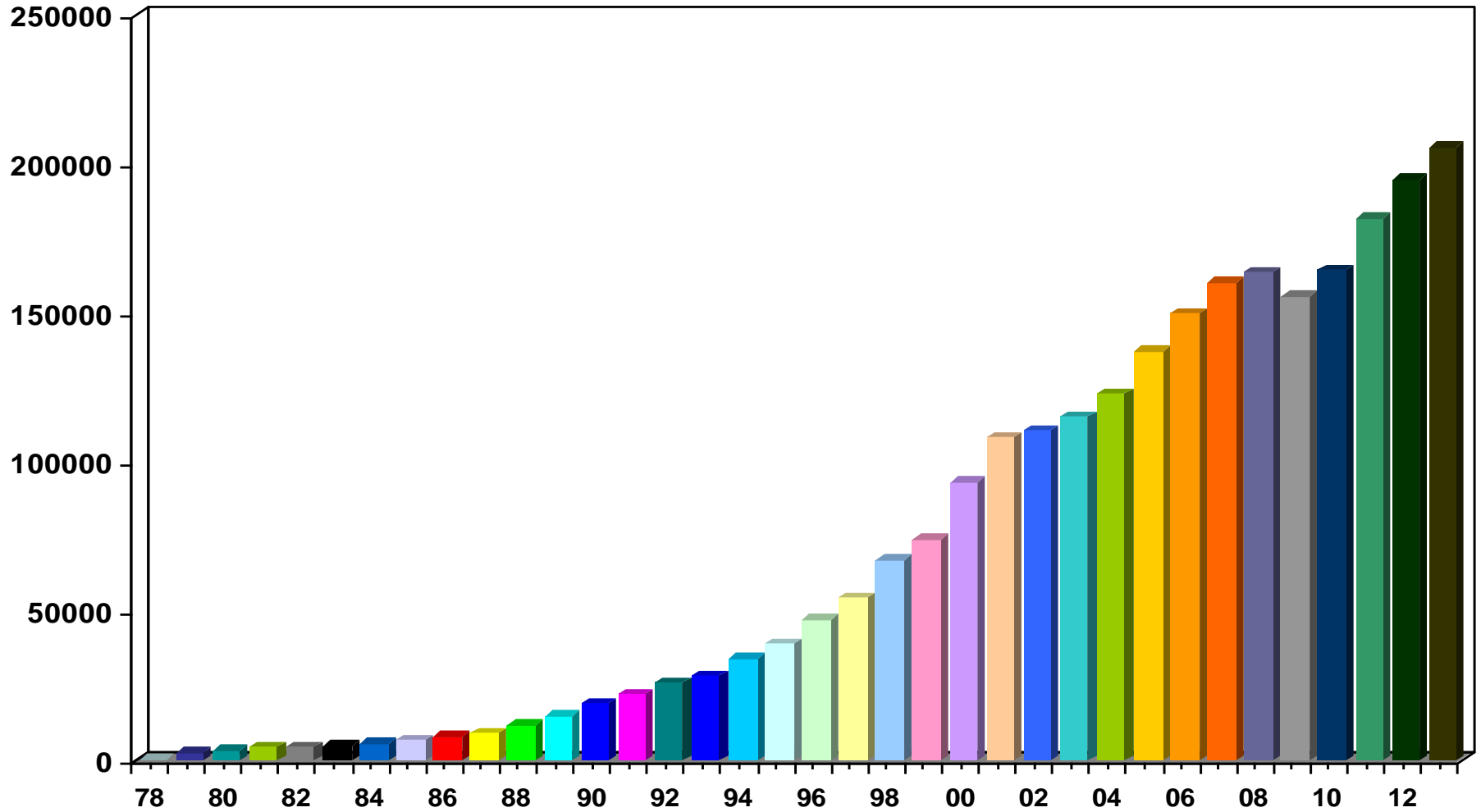

**2013: 205,300 PCT applications (+5.1%)**

# TRENDS IN PCT FILING

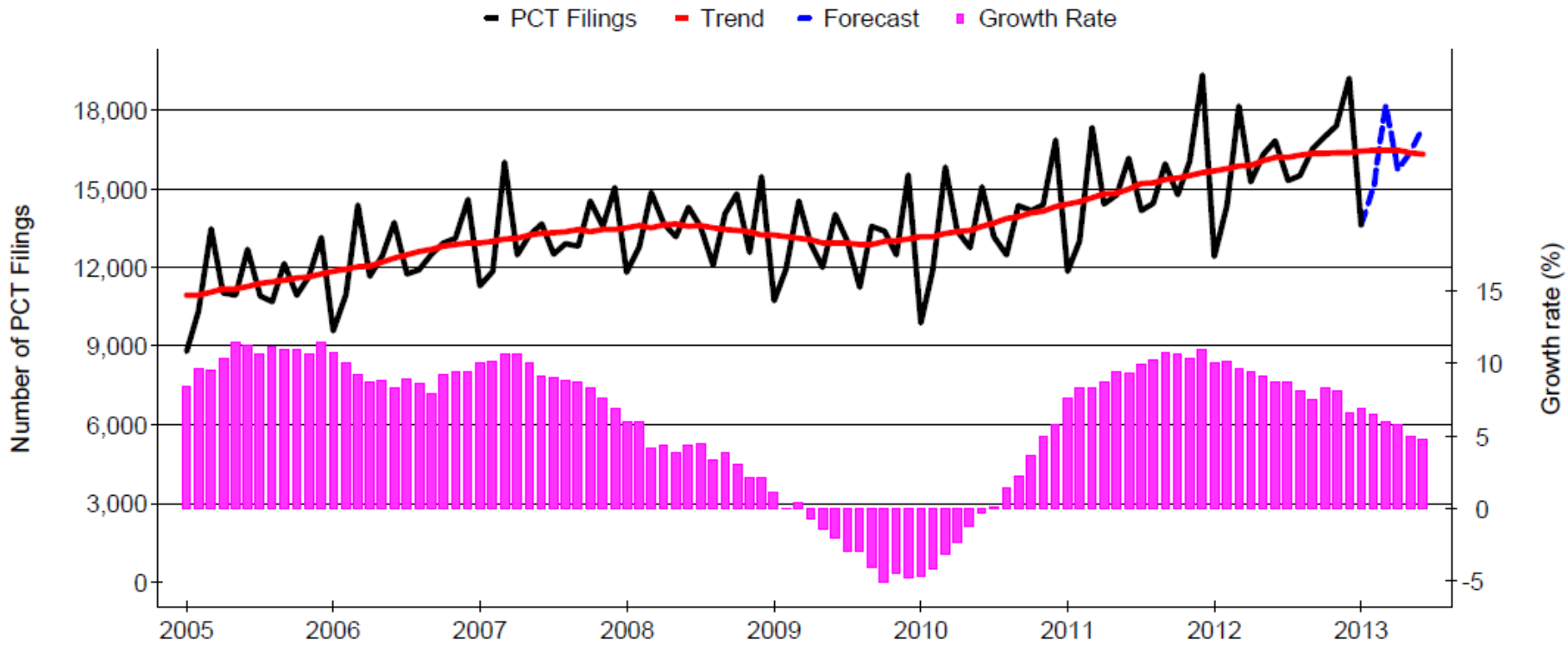

# INTERNATIONAL APPLICATIONS RECEIVED IN 2013 BY COUNTRY OF ORIGIN

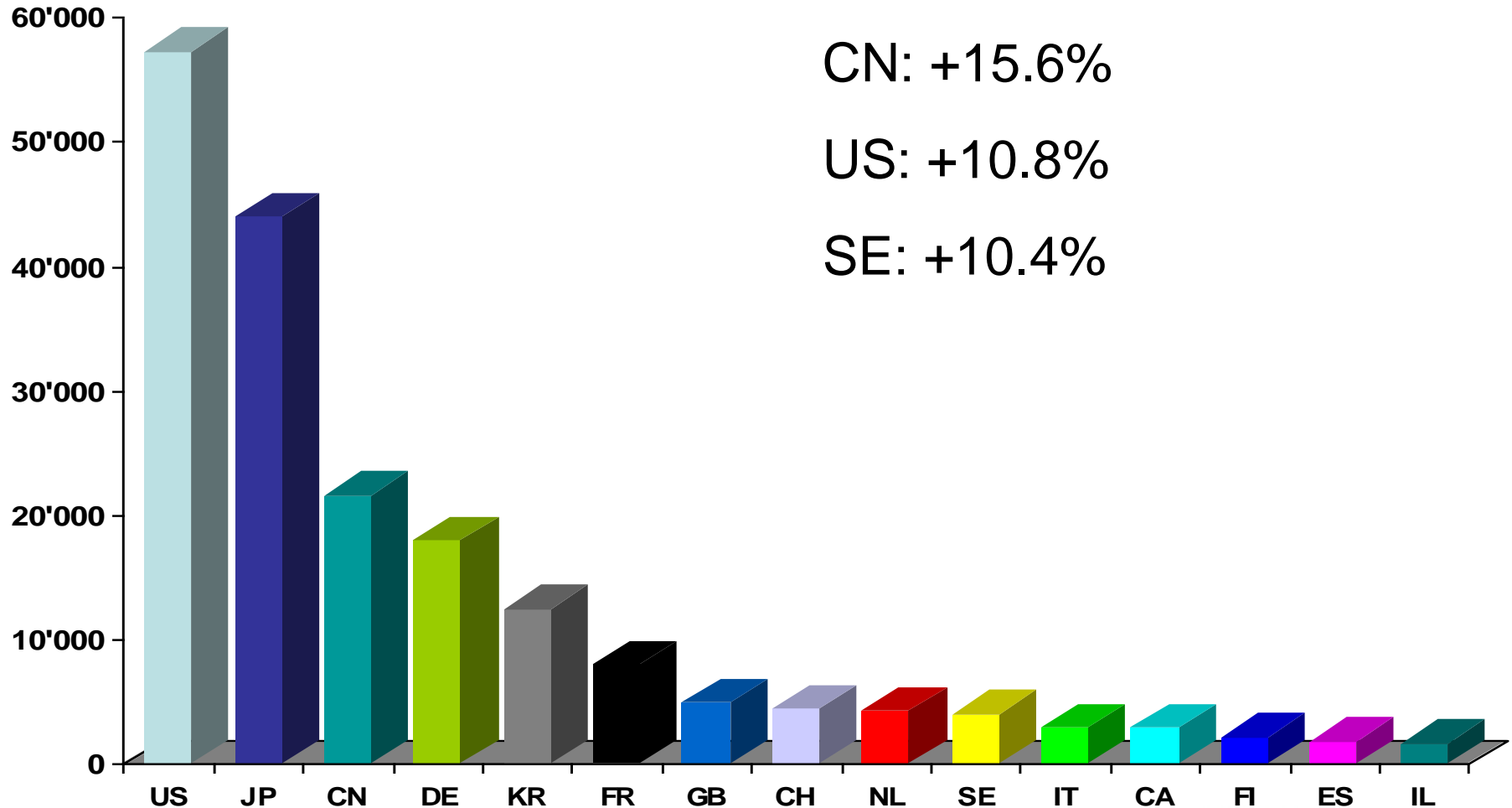

# PCT NATIONAL PHASE ENTRIES—TOTAL

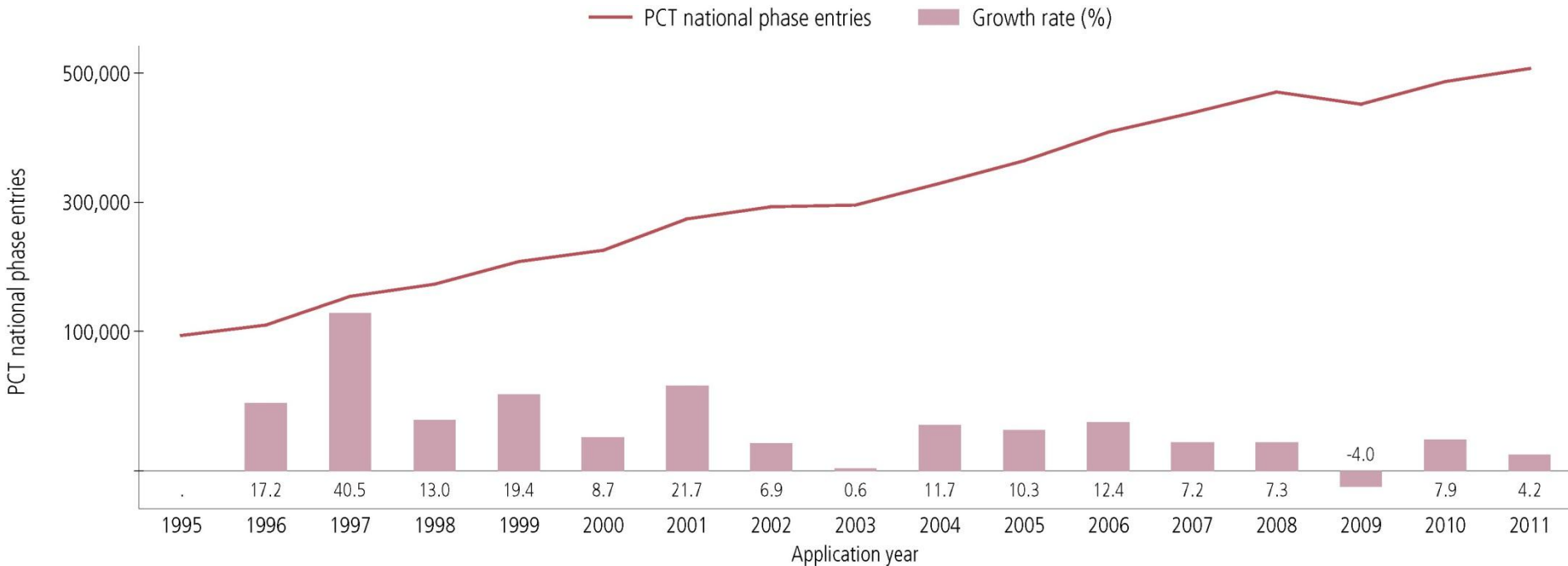

507,400 national phase entries estimated in 2011 (+ 4.2%)

431,800 (about 85%) of NPEs are from non-resident applicants, making PCT NPEs responsible for 54.9% of all non-resident patent applications filed worldwide in 2011

# PCT NATIONAL PHASE ENTRIES 2011—BY TARGET DO (1)

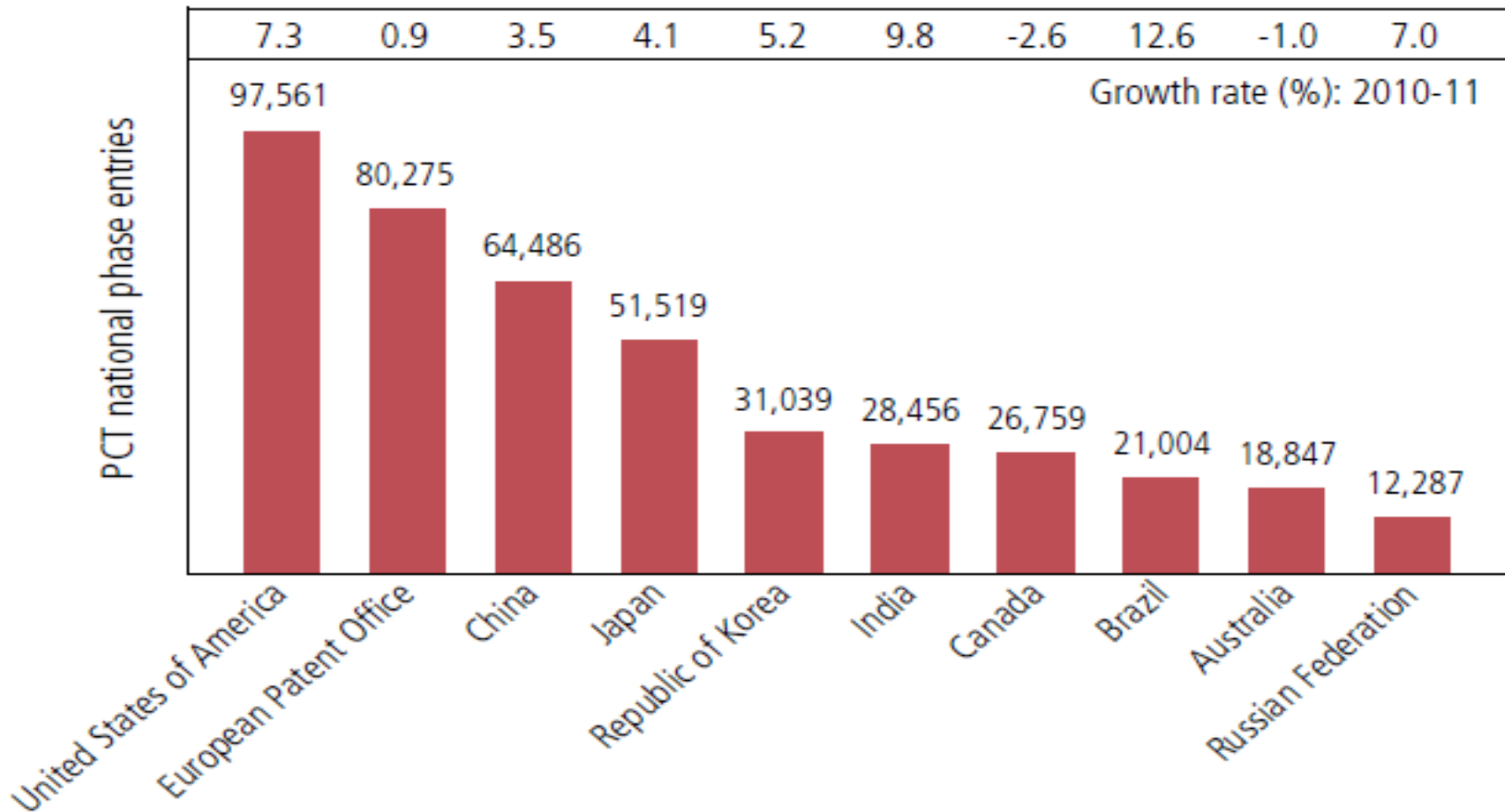

USPTO most preferred DO for National Phase Entries; had highest growth among the IP5 Offices (+7.3%)  
 Brazil (+12.6%) and India (+9.8%) had highest growth rates among top 10 Offices

# PCT NATIONAL PHASE ENTRIES 2011— BY TARGET DO (2)

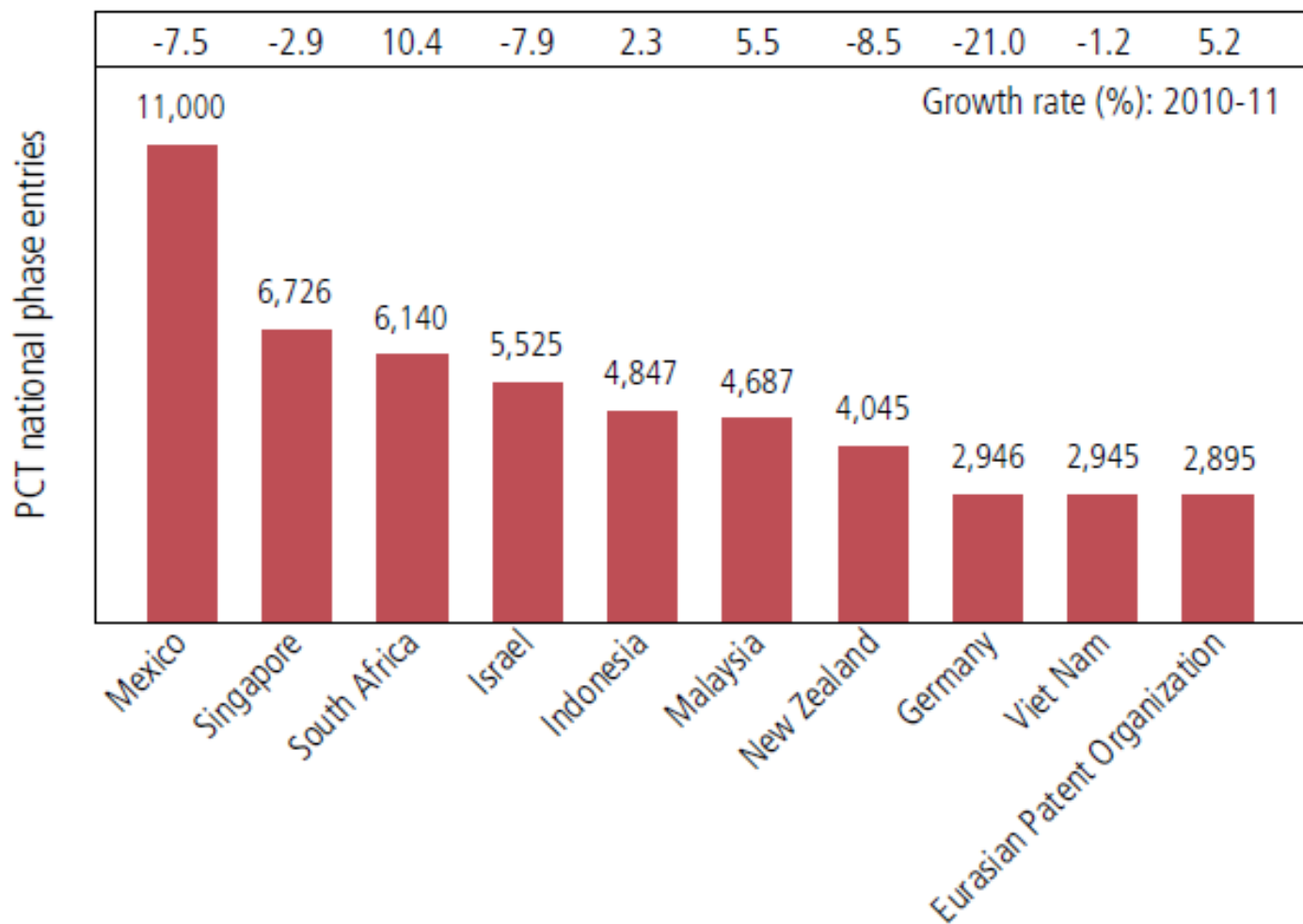

# TOP PCT APPLICANTS 2013

1. Panasonic—JP (2881)
2. ZTE—CN (2309)
3. Huawei—CN (2094)
4. Qualcomm—US (2036)
5. Intel—US (1852)
6. Sharp—JP (1840)
7. Bosch—DE (1786)
8. Toyota—JP (1696)
9. Ericsson—SE (1467)
10. Philips—NL (1423)
11. Siemens—DE (1323)
12. Mitsubishi Electric—JP (1312)
13. Samsung Electronics—KR (1193)
14. NEC—JP (1190)
15. LG Electronics—KR (1170)
16. Fujifilm Corporation (1008)
17. Shenzhen China Star Optoelectronics—CN (916)
18. Sony—JP (915)
19. Hitachi—JP (841)
20. Nokia—FI (807)

( ) of published  
PCT applications

# TOP UNIVERSITY PCT APPLICANTS 2013

1. University of California (US)
2. MIT (US)
3. Columbia University (US)
4. University of Texas (US)
5. Harvard University (US)
6. Johns Hopkins (US)
7. Korea Advanced Institute of Science and Technology (KR)
8. Leland Stanford University (US)
9. Cornell University (US)
10. Cal Tech (US)
11. University of Florida (US)
12. Postech Foundation (KR)
13. Seoul National University (KR)
14. Peking University (CN)
15. Nanyang Technical University (CN)
16. University of Tokyo (JP)
17. Isis Innovation Limited (GB)
18. University of Pennsylvania (US)
19. University of Michigan (US)
20. National University of Singapore (SG)



# THE PCT – 1970 TO TODAY

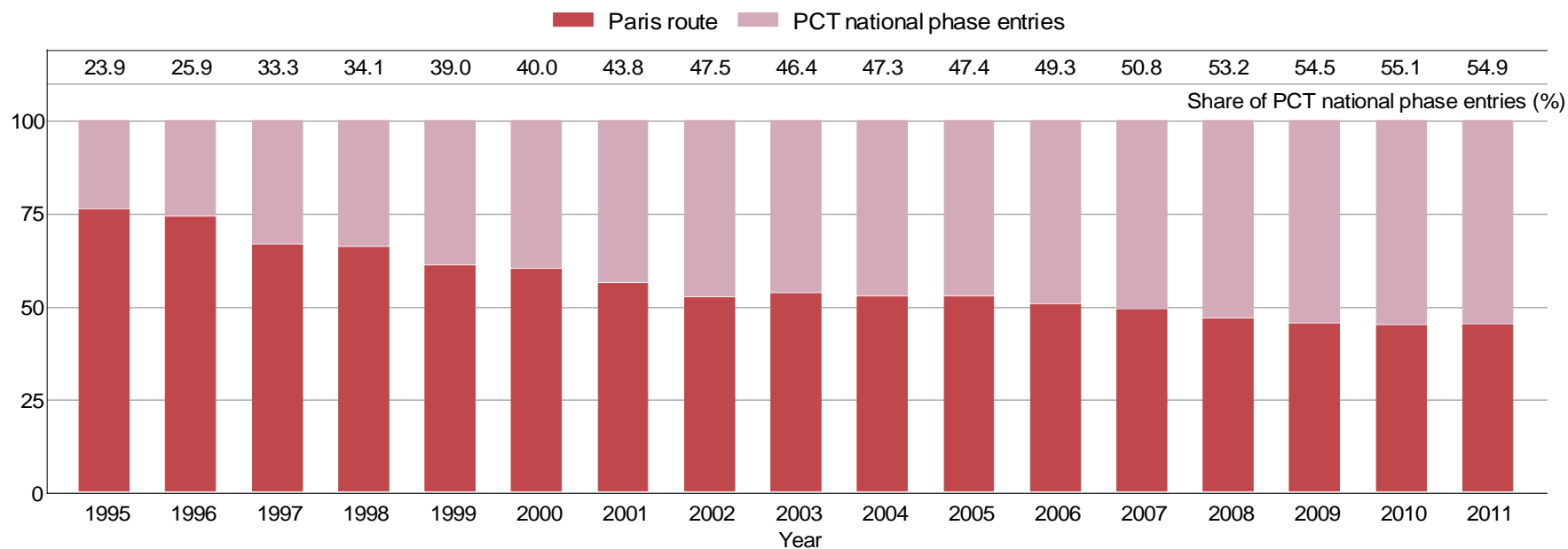

# THE PCT – 1970 TO TODAY



**PCT percentage at IP5 offices by IP5 origin (2011)**

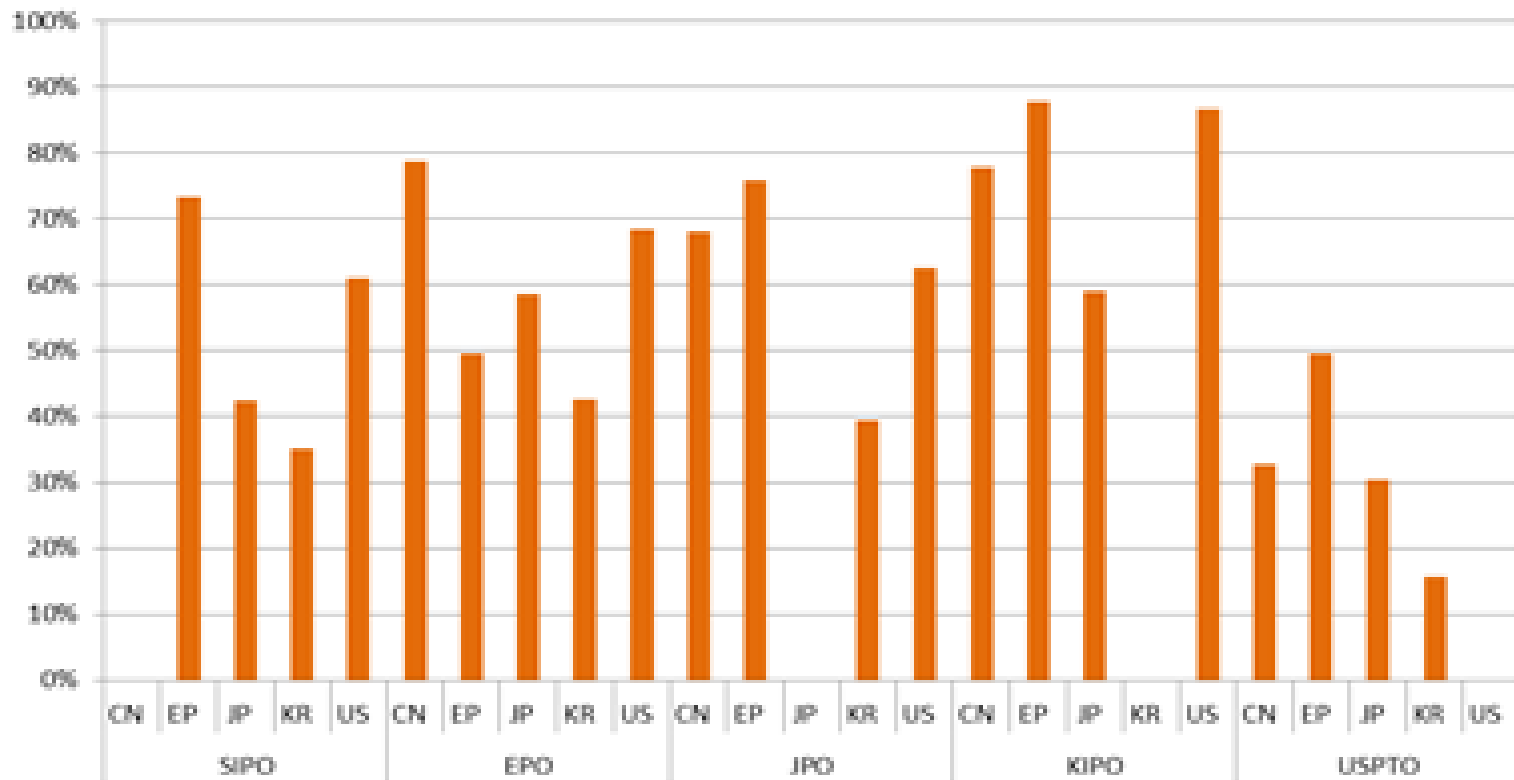

# CERTAIN PCT ADVANTAGES

The PCT, as the cornerstone of the international patent system, provides a worldwide system for simplified filing and processing of patent applications, which:

1. postpones the major costs associated with internationalizing a patent application
2. provides a strong basis for patenting decisions
3. harmonizes formal requirements
4. protects applicant from certain inadvertent errors
5. evolves to meet user needs
6. is used by the world's major corporations, universities and research institutions when they seek international patent protection

# PCT CHALLENGES

- Improving the quality of PCT international phase work products
- Building trust between patent offices, so that duplicative international phase and national phase processing can be reduced
- Language issues
  - 33% of applications filed in Chinese, Japanese and Korean
- Helping developing countries benefit from the PCT
  - 15 countries responsible for 92.1% of IAs published in 2011
- Making PCT accessible to applicants of all types from all Contracting States (for example, SMEs)
- Helping PCT users stay abreast of new developments and strategies

# THE PCT— 1970 TO TODAY



- PCT extremely successful as filing tool
- Harmonization of formal and procedural requirements (beyond PCT: national laws; Patent Law Treaty (PLT))
- However: PCT not as effective as work sharing tool in practice for addressing national quality of examination and (for some Offices) backlogs
- Expectation was: “flying start” for offices, work should be “rather in the nature of completing, checking and criticizing than starting from scratch in complete isolation”
- Reality is: many Offices do start “from scratch”
  - Perhaps not in complete isolation, but ...

# PCT ROADMAP



- Needed: change in approach of offices vis-à-vis the PCT system, including a review of national procedures and practices and of what kind of incentives are set to use the system in a way which is beneficial to all

# PCT ROADMAP



- Improve quality and consistency of international reports:
  - The better the quality of the tools (reports), the better for all Contracting States: tools allow them to deal more effectively with requirements of their national laws
  - The smaller the national examining capacity, the bigger the importance of quality tools

# PCT ROADMAP



## ■ Improve quality and consistency of international reports:

- Develop quality metrics for measuring usefulness
- Explore collaborative search and examination
- Third party observations system
- Set up quality feedback system for offices
- Improve explanations of relevance of cited documents
- Extend opportunity for dialogue with examiner during international preliminary examination



# PCT ROADMAP



- Improve timeliness of actions in international phase
- Create incentives for applicants to use system efficiently
  - encourage high quality applications and early correction of defects and filing of amendments
- Improve training for Offices, better coordination
  - notably for examiners in developing country Offices
- Improve access to effective search systems
  - affordable access to online search systems
- Improve access to national search and examination reports

# ePCT

- WIPO online service that provides secure electronic access to/interaction with IB's PCT application files by applicants/agents and Offices
- 8500 users in over 100 countries, 30+ Offices
- Positive feedback from users:
  - applicant features generally reckoned best in class
  - unique notifications feature already saved applicants
  - Office features found easy to use
- More information: <https://pct.wipo.int/ePCT>
- ePCT-Filing: web-based electronic filing of new PCT applications
  - Currently available live for filings with RO/IB, RO/AT & RO/SE; awaiting other ROs

# ePCT: FURTHER IMPROVEMENTS

- Aiming for fully hosted RO service by end 2014
- Multilingual interface (eventually 10 languages)
- Extension of ePCT to interested Offices in their various capacities (RO, ISA, SISA, IPEA, DO, EO)
- Goal to offer centralized real-time credit card transactions for all fee types and all authorities
- National phase entry function could be added to ePCT
  - Applicant would select from among participating DOs, upload any necessary documents and add any bibliographic data not already available to IB
  - Local counsel could be fully involved, as needed

# Indication of availability for license

- PCT applicants can indicate in relation to their published applications that the invention is available for license
  - Request to IB, within 30 months from the priority date, free of charge
- Licensing indications made publicly available after international publication of the application on PATENTSCOPE
- International applications containing such licensing indication requests can be searched in PATENTSCOPE
- Most use thus far from universities/research institutions

# PCT TRAINING OPTIONS

- **New:** 29 video segments on WIPO's YouTube channel and WIPO's PCT page about individual PCT topics
  
- PCT Distance learning course content available in the 10 PCT publication languages
  
- PCT Webinars
  - providing free updates on developments in PCT procedures, and PCT strategies—previous webinars are archived and freely available
  
  - upon request also for companies or law firms, for example, for focused training on how to use ePCT
  
- In-person PCT Seminars and training sessions

# PCT RESOURCES/INFORMATION

- For further information about the PCT, see

Website: <http://www.wipo.int/pct/en/>

- For general questions about the PCT, contact the PCT Information Service at:

Telephone: (+41-22) 338 83 38

Facsimile: (+41-22) 338 83 39

E-mail: [pct.infoline@wipo.int](mailto:pct.infoline@wipo.int)



# Thank You!

\*\*\*\*\*

Mr. Claus Matthes

Director

Patent Cooperation Treaty (PCT) Business Development Division  
World Intellectual Property Organization (WIPO)

T + 41 22 338 98 09

Email: [claus.matthes@wipo.int](mailto:claus.matthes@wipo.int)

Website: [www.wipo.int](http://www.wipo.int)

# THE MADRID SYSTEM THE HAGUE SYSTEM & THE LISBON SYSTEM



Speaker: Mrs. Asta Valdimarsdottir, Director, Operations Division, Madrid Registry, Brands and Designs Sector, WIPO



## ■ Trademarks



THE WORLD NEEDS NATA

IRN 1159604

WIPO | MADRID

The International Trademark System

## ■ Designs



DM/081 852

WIPO | HAGUE

The International Design System

## ■ Appellations of Origin

Number	682
Date	18.03.1983
Holder	Instituto do Vinho do Douro e do Porto
Appellation	<b>PORTO</b>
Publication	N° 15 : 11/1983
Country of Origin	<b>PT</b>
Nice Classification	33
Product	Generous wine (liqueur wine)
Area of Production	The Douro region (approximately 240.000 ha.) delimited under article 2 of Decree No 7934, December 10, 1921

WIPO | LISBON

The International System of Appellations of Origin

# NO INTERNATIONAL PROCEDURE

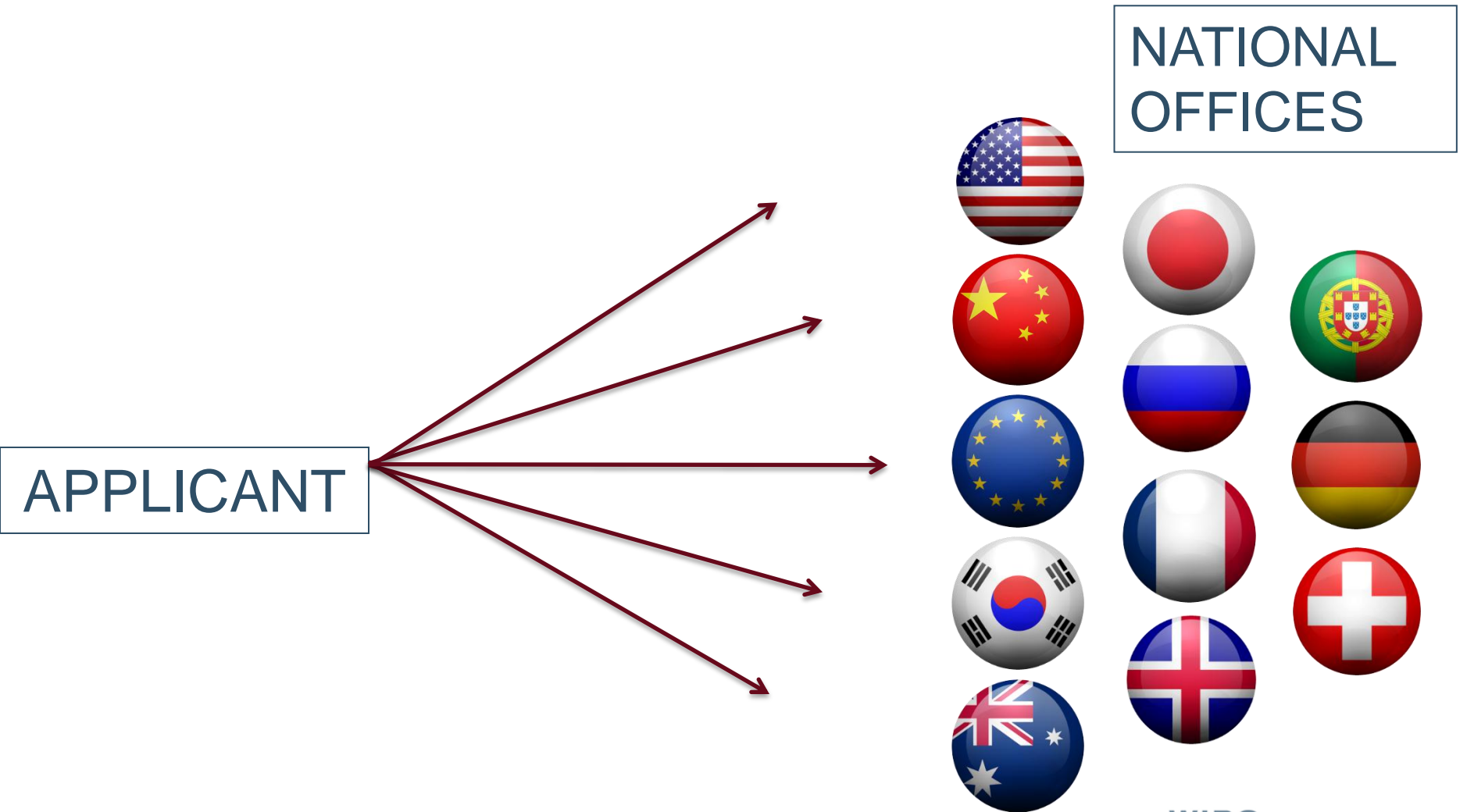

# INTERNATIONAL PROCEDURE

## MADRID

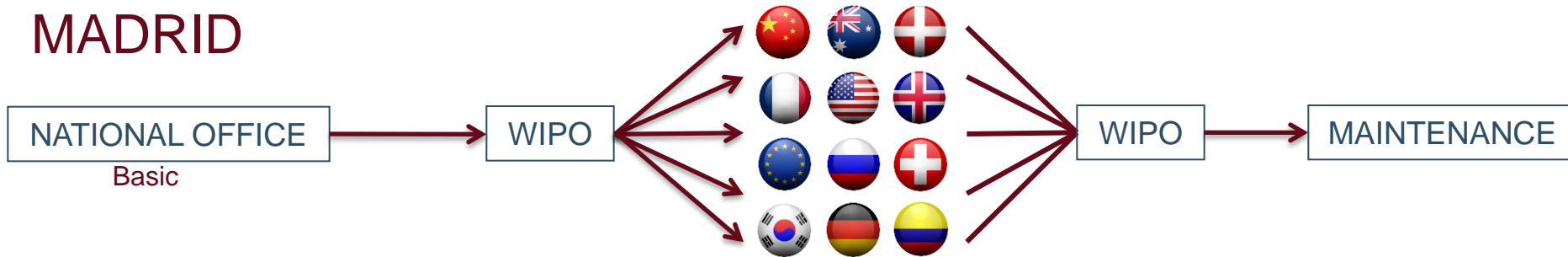

## HAGUE

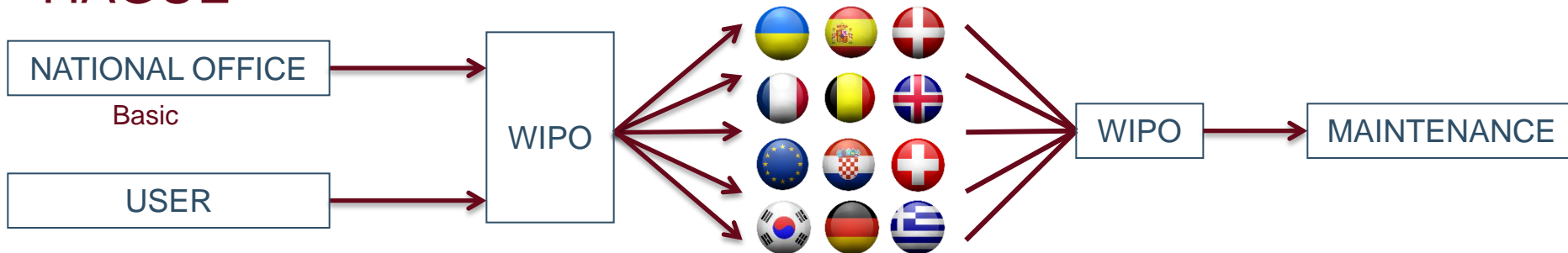

## LISBON



# THE MADRID SYSTEM

# TRADEMARKS

- *"A brand incarnates an enterprise's reputation and image and so is one of an enterprise's most valuable assets"* (Director General, Francis Gurry)
- Trademarks are the most widely used form of registered intellectual property (IP) throughout the world
- Trademark demand quadrupled between 1985 and 2011, from just under 1 million applications per year in 1985 to 4.2 million by 2011

# THE MADRID SYSTEM - FACTS AND FIGURES

- Worldwide trademark filings + 9.3% from 2008 - 2013
  
- Madrid filings
  - + 4.1% in 2012
  - + 6.4% in 2013
  - + 7.4% this year
  
- 578.320 international registrations in force
  
- 5.61 million designations in force
  
- 191.759 holders of international registrations



# Madrid Union **Market** (inhabitants)





# ACCESSIONS

- 2012: Colombia, Mexico, New Zealand and Philippines
- 2013: India, Rwanda and Tunisia (October 16, 2013)
- Future accessions?
  - Latin American countries
  - ASEAN countries by 2015
  - Caribbean countries
  - African countries

# TOP FILING STATES – 2013

<b>States/regional entities</b>	<b>Change from 2012</b>
European Union	15.3%
United States of America	4.8%
Germany	6.1%
France	0.7%
Switzerland	10.7%
Italy	-1.2%
China	10.9%
Japan	-9.3%
Benelux	0.1%
United Kingdom	17.2%

# TOP DESIGNATIONS – 2013

<b>States/regional entities</b>	<b>Change from 2012</b>
China	18.1%
Russian Federation	24.4%
European Union	23.7%
United States of America	23.2%
Japan	25.5%
Switzerland	9.3%
Australia	32.6%
Republic of Korea	30.4%
Turkey	10.9%
Ukraine	11.6%

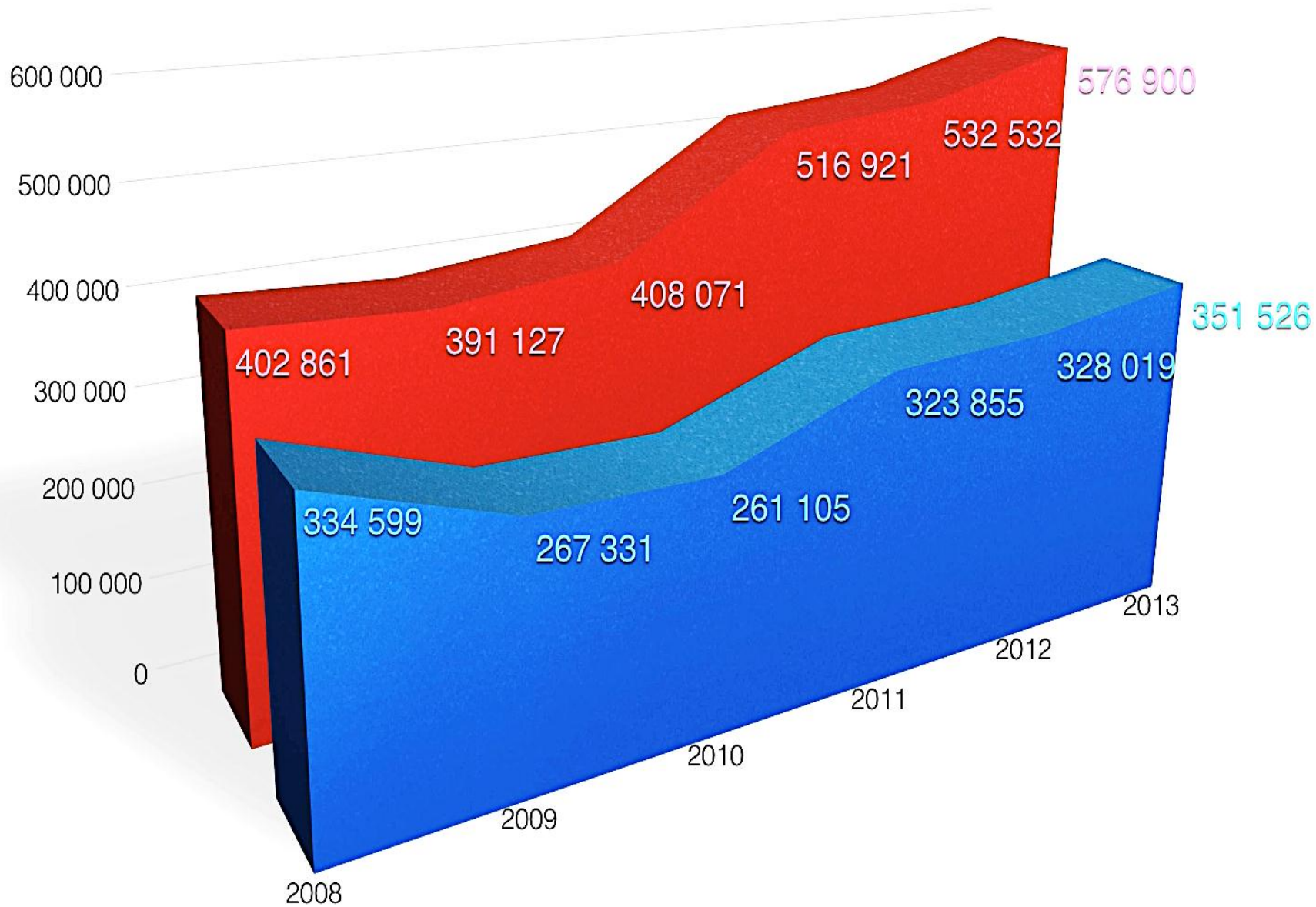

■ NUMBER OF DESIGNATIONS ■ NUMBER OF REQUESTS RECEIVED

# EXAMPLE OF THE LIFE CYCLE OF AN INTERNATIONAL REGISTRATION

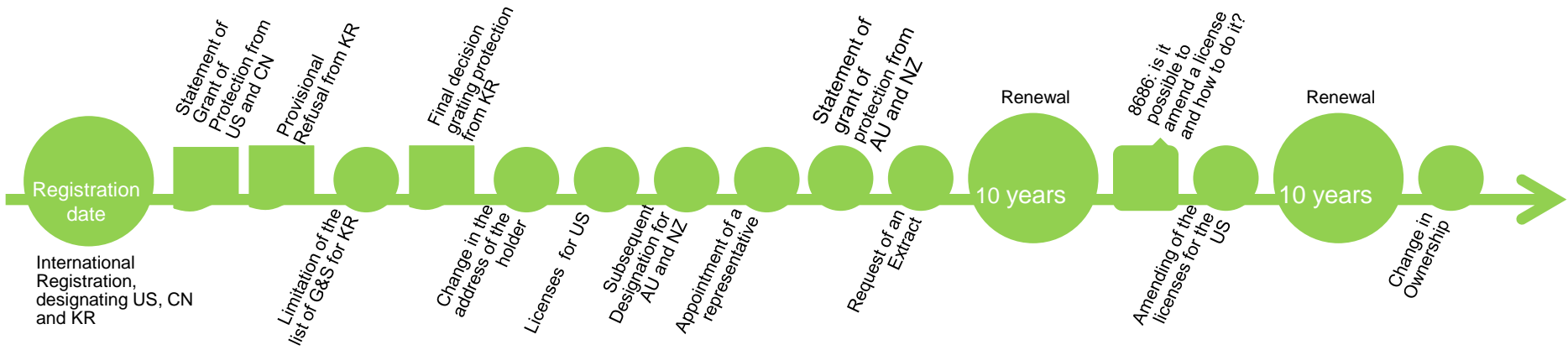

*The Madrid customer service and the Madrid teams are always available by phone or e-mail*

# MADRID SYSTEM – I

- A registration system for 92 Contracting Parties
  
- One application – one language – one set of fees
  
- Three main stages
  - Basic application/basic registration > International application
  
  - Formal examination by WIPO
  
  - Substantive examination by the Offices of the designated Contracting Parties

# MADRID SYSTEM – II

- One registration covering multiple territories
- Manage a portfolio of trademarks via a single centralized system
- Renew in all designated Contracting Parties with one request
- Expand protection to new Contracting Parties

# MADRID SYSTEM – III

- All transactions are done with the appropriate form.
  - 19 forms for applying for a registration and managing the registration
  - available in the three working languages (E/F/S)
  - can be sent to the IB by e-mail to [interg.mail@wipo.int](mailto:interg.mail@wipo.int)
  - some forms are already available through e-filing:
    - ❖ [E-subsequent designation](#)
    - ❖ [E-renewal](#)



# MADRID SYSTEM – IV

- Fees can easily be paid by:
  - Credit card using [E-payment](#) / [E-subsequent designation](#) / [E-renewal](#)
  - WIPO current account
  - Bank transfer
  
- More information about the payment of fees is available at:  
<http://www.wipo.int/about-wipo/en/finance/madrid.html>
  
- One can calculate the cost of an application, subsequent designation or a renewal at: <http://www.wipo.int/madrid/en/fees/calculator.jsp>

# THE NATIONAL ROUTE VS. THE MADRID ROUTE

- Filing in several Offices
  - Many application forms
  - Several languages
  - Several currencies
  - Several registrations
  - Several renewals
  - Several modifications
  - Foreign attorney needed from filing
- Filing in one Office
  - One application form
  - One language (E/F/S)
  - One currency (CHF)
  - One international registration
  - One renewal
  - One modification
  - Foreign attorney first needed in case of refusal

# GENERAL PROFILE 2013

## 44,414 International Registrations

Average Number of Designations	6.9
Average Number of Classes	2.5
Average Fee	CHF 2,926
All Fees	70% < 3,000 CHF

# INTERNATIONAL APPLICATIONS AND REGISTRATIONS FROM PORTUGAL



	2006	2007	2008	2009	2010	2011	2012	2013
Registrations	310	331	338	161	145	158	169	208
Applications	276	355	344	135	149	175	154	226

# DESIGNATIONS IN INTERNATIONAL REGISTRATIONS AND SUBSEQUENT DESIGNATIONS – DCP: PORTUGAL

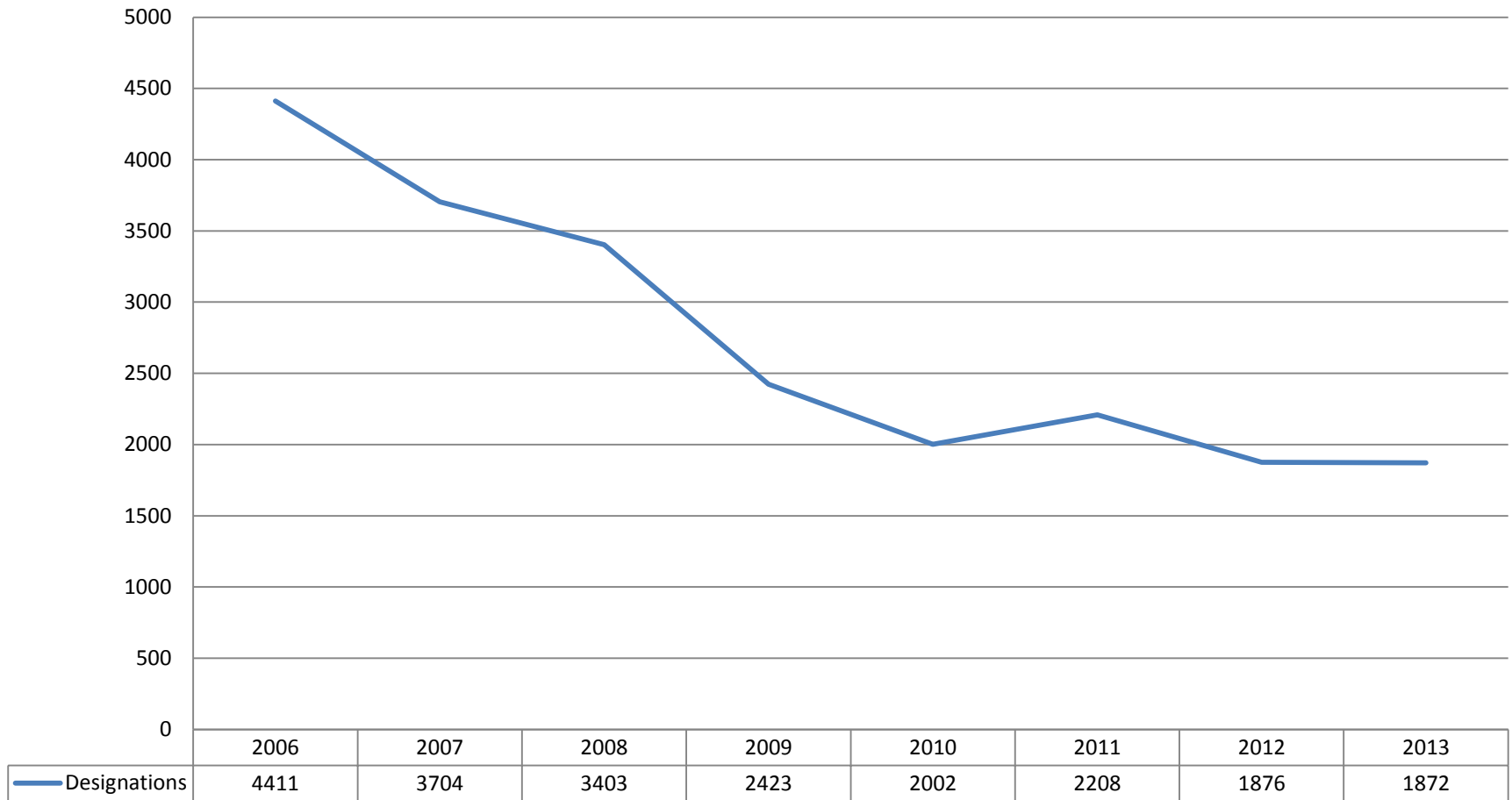

# DESIGNATIONS IN INTERNATIONAL REGISTRATIONS AND SUBSEQUENT DESIGNATIONS DCP: PORTUGAL

Total number of designations: 1,872

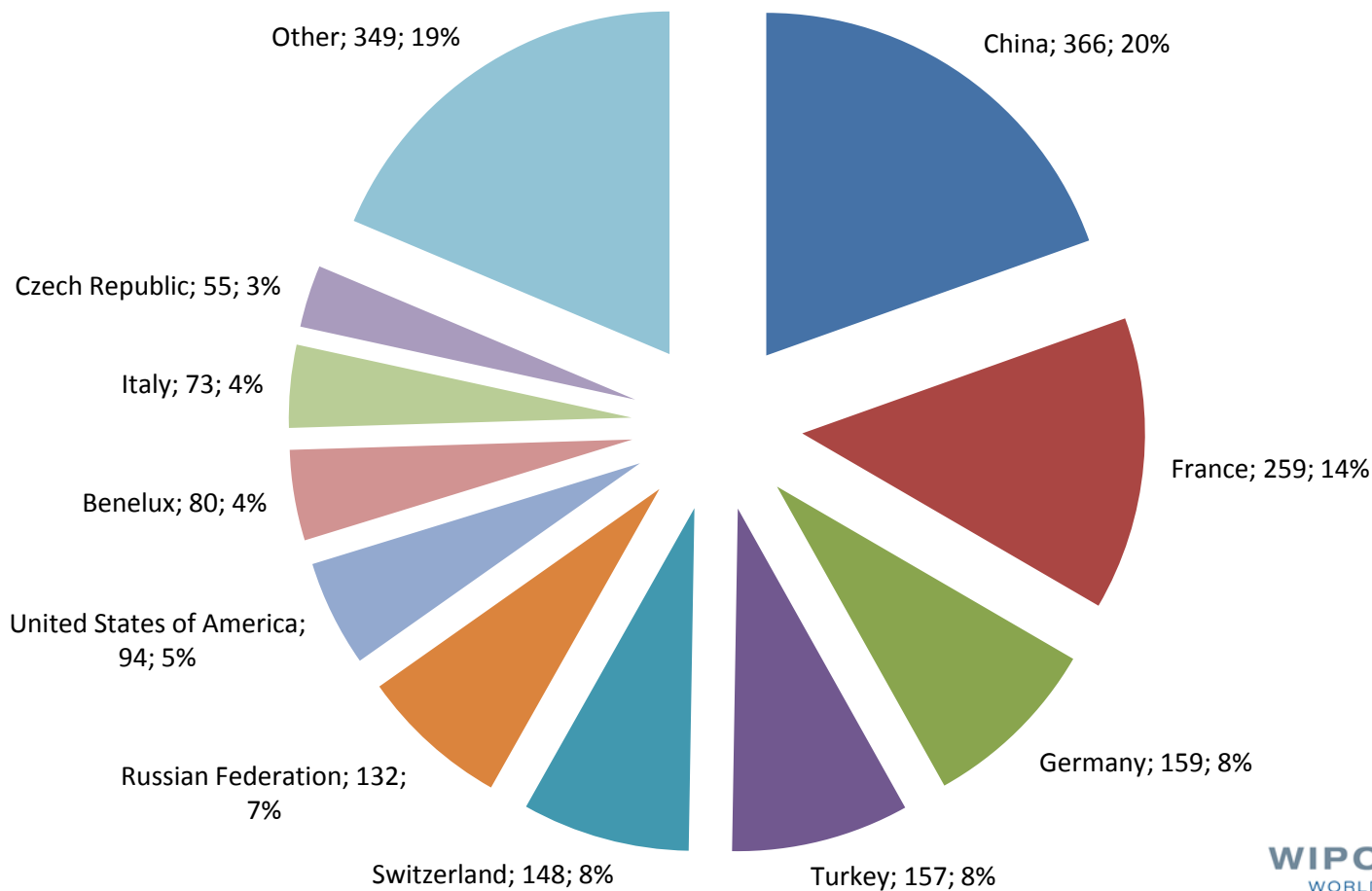

# ONLINE INFORMATION SERVICES

- Legal texts, Guide and Information Notices
- WIPO Gazette of International Marks
- ROMARIN: Online search database
- E-Forms: e-renewal and e-subsequent designations
- Fee Calculator: Costing service
- Dynamic Madrid Statistics

free access at <http://www.wipo.int/madrid/en/>

# ONLINE TOOLS

- **MGS (Madrid Goods and Services Manager):** To use correct specifications of goods and services
- **MRS (Madrid Real-Time Status):** To check the status of an international application/registration
- **MPM (Madrid Portfolio Manager):** To enable holders and representatives to view and modify their portfolio
- **MEA (Madrid Electronic Alert):** To enable users to submit a list of IRs to monitor and to be informed by email when any of them change
- Accessible from <http://www.wipo.int/madrid/en/services/>



# E - SUBSEQUENT DESIGNATION



WORLD INTELLECTUAL PROPERTY ORGANIZATION

[Home](#) > [IP Services](#) > [Madrid System for the International Registration of Marks](#) > [Online Subsequent Designation](#)

## ONLINE SERVICES

[e-Payment](#)  
[e-Renewal](#)  
[Gazette](#)  
[MEA](#)  
[MGS](#)  
[MPM](#)  
[MRS](#)  
[Romarin](#)

## Online Subsequent Designation

Please enter your International Registration Number

IRN

# Madrid – The International Trademark System

The Madrid System is a one stop solution for registering and managing marks worldwide.

- Main features of the system
- Main Members
- Mem Legal texts
- Legal Working Groups and Assemblies
- Work



More videos about the Madrid System

## News

- WIPO at the 136th INTA Annual Meeting, Hong Kong, China Mar 25, 2014
- WIPO at Making the Most of the Madrid System : Information and Practical Tips on How to Use Specific Forms Mar 13, 2014

All news

## Key resources

### Key resources

#### General information

Madrid Highlights

Information concerning national or regional procedures before IP offices under the Madrid System

#### File an application

FAQs

The Madrid System

#### For IP offices

#### Current fees

Information

Fee calculator

E-payment

#### Content

Warning - requests for payment of fees

#### General

#### Submission

#### Madrid File an application

E-mail: | Tel: (41) The Madrid system is a simple, centralized, cost effective and flexible solution to register your mark in up to 92 Contracting Parties. Fax: (41)

#### Legal & procedural information

Madrid treaties

Guide to the International Registration of Marks under the Madrid Agreement and the Madrid Protocol

Information notices

WIPO Gazette of International Marks

Declarations made under the Madrid Agreement and the Madrid Protocol

Offices practices on replacement and survey

#### Statistics

Annual

Monthly

In progress

#### Online services

ROMARIN

MGS (Madrid Goods & Services Manager) | Tutorial

MPM (Madrid Portfolio Manager) | Tutorial

MRS (Madrid Real-time Status) | Tutorial

MEA (Madrid Electronic Alert ) | Tutorial

E-payment

E-renewal

E-subsequent designation | Tutorial

#### Other

Forms | E-forms

Electronic Notification Service

International Application Simulator

Translation request

All resources



#### Manage a registration

Once your mark is registered, you can easily manage your rights through the International Bureau in a single request (i.e., change in ownership, limit the scope, etc.).

#### For IP offices

# THE HAGUE SYSTEM

# HAGUE UNION

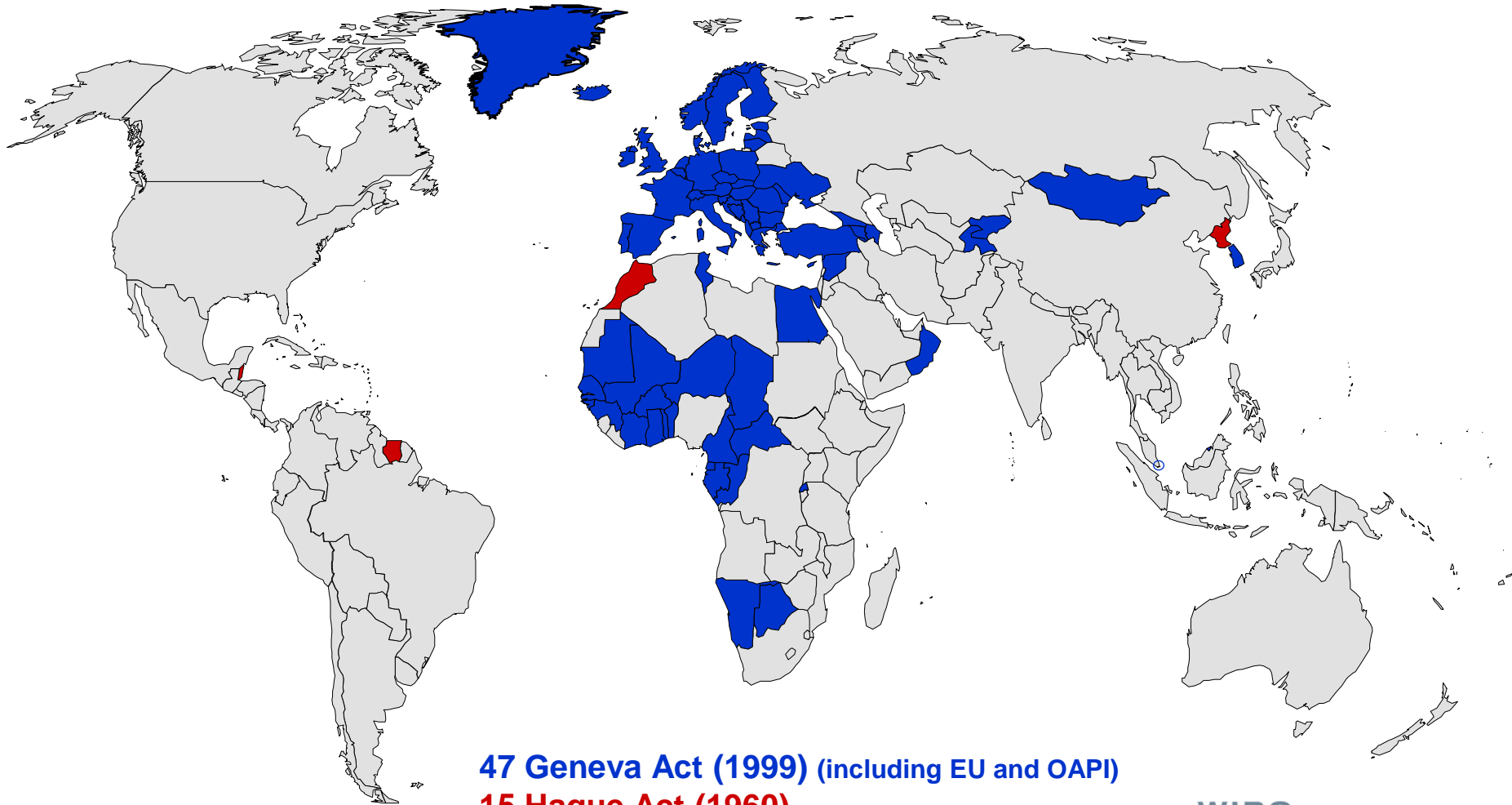

**47 Geneva Act (1999) (including EU and OAPI)**

**15 Hague Act (1960)**

---

**62 Contracting Parties**

# ACCESSIONS

- 2010: Germany, Norway, Azerbaijan
  
- 2011: Finland, Monaco, Rwanda
  
- 2012: Montenegro, Tajikistan, Tunisia
  
- Future accessions?
  - China, Japan and USA
  - Russian Federation and Belarus
  - ASEAN countries by 2015
  - Barbados and Trinidad & Tobago
  - Madagascar and Morocco

# FORESEEN EXPANSION OF THE HAGUE SYSTEM

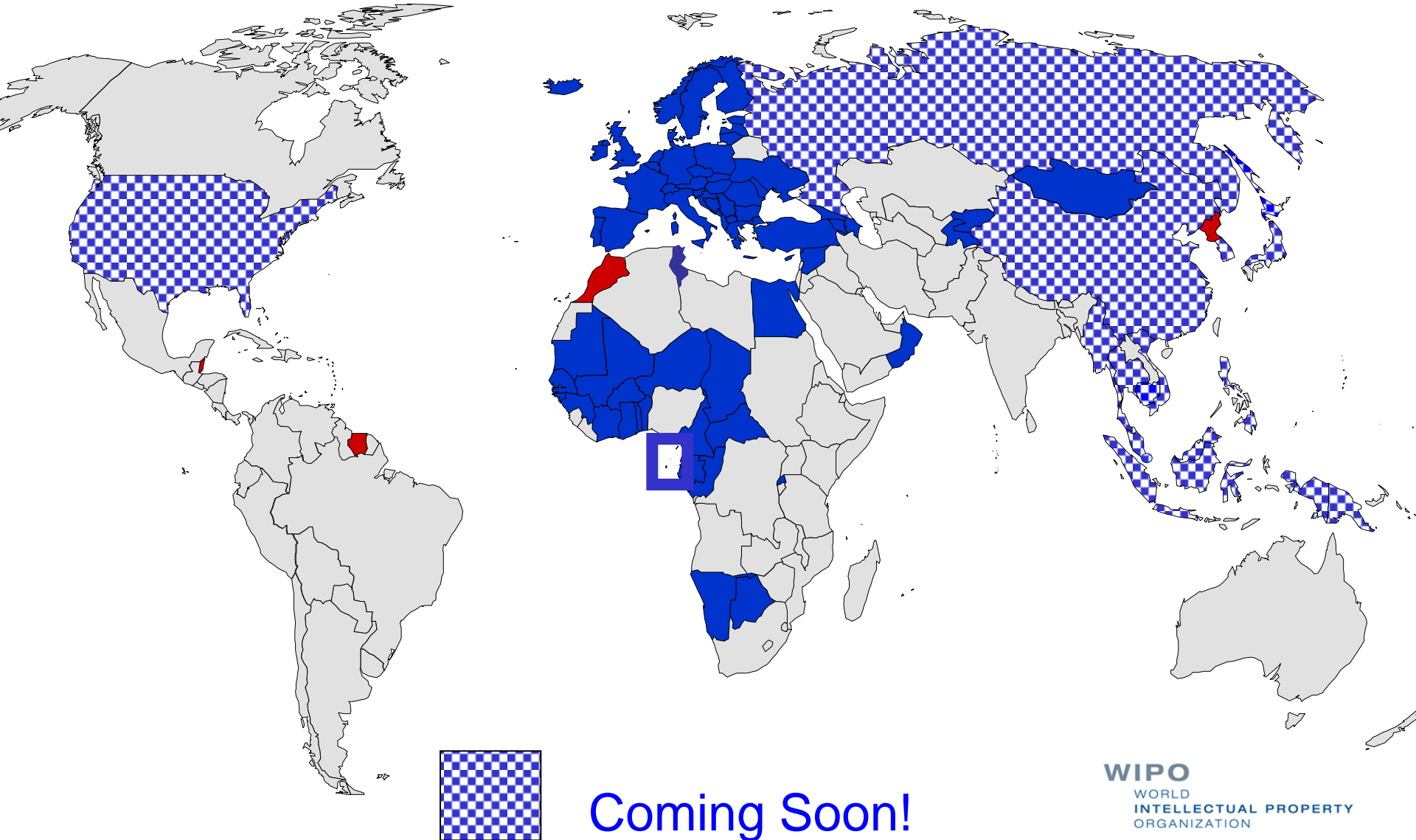

# THE USE OF THE HAGUE SYSTEM IN 2012

- 2,604 international applications filed (12,454 designs)
- 2,440 international registrations recorded (11,971 designs)
- Largest filers: Swatch AG, Daimler AG, Koninklijke Philips Electronics
- Approximately 26,284 international registrations in force, containing 110,158 designs
  - Equivalent to over 131,420 designations in force
  - Involving 8,029 holders

# TOP FILING CONTRACTING PARTIES

## Contracting Party of entitlement

- 1. European Union (5168 designs, 41.5%)
- 2. Switzerland (2855 designs, 22.9%)
- 3. Germany (1630 designs, 13.1%)
- 4. France (1265 designs, 10.2%)
- 5. Turkey (278 designs, 2.2%)
- 6. Norway (186 designs, 1.5%)
- 7. Spain (101 designs, 0.8%)
- 8. Poland (86 designs, 0.7%)
- 9. Croatia (76 designs, 0.6%)
- 10. Liechtenstein (73 designs, 0.6%)



# MOST DESIGNATED CONTRACTING PARTIES

Number of designs recorded:

- 1. European Union (8961 designs, 74.9%)
- 2. Switzerland (8802 designs, 73.5%)
- 3. Turkey (5110 designs, 42.7%)
- 4. Ukraine (2853 designs, 23.8%)
- 5. Singapore (2531 designs, 21.1%)
- 6. Norway (2389 designs, 20%)
- 7. Croatia (2376 designs, 19.8%)
- 8. Morocco (1853 designs, 15.5%)
- 9. Liechtenstein (1499 designs, 12.5%)
- 10. Serbia (1494 designs, 12.5%)

# KEY PRINCIPLES OF THE HAGUE SYSTEM (1)

## ■ Entitlement:

In order to use the Hague system, you need a connection with a Contracting Party (CP), such as establishment, domicile, nationality or habitual residence

## ■ One file > many territories:

File a single international application for a single international registration (IR) in which one or more Contracting Parties (CP) are designated (“self-designation“ is possible)

## ■ Renewal:

Duration: 5 years renewable. 15 years for the 1999 Act or possibly longer if allowed by a designated CP

# KEY PRINCIPLES OF THE HAGUE SYSTEM (2)

- Possible deferment of up to 30 months:

Counted from date of filing or priority date

- Fixed Time Limit for Refusal:

Any refusal must be notified to the International Bureau within 6 or 12 months from the publication of the international registration on the WIPO website, otherwise the design will be deemed protected

- “Bundle of Rights”:

If no refusal is issued, the resulting IR has the effect of a grant of protection in each designated CP

# THE REGISTRATION PROCEDURE

- Only formal examination in the International Bureau
  - Recording in the International Register
  - Publication in the *International Designs Bulletin*
  - Notification to designated CPs through the publication
  
- Substantive examination by the designated Contracting Parties only
  
- Refusal must be received by the International Bureau within a set time limit after publication: 6 or 12 months

# E-FILING/FORMS

(<http://www.wipo.int/hague/en/forms/>)

Form	Latest revision	Description	Downloadable paper versions	Online versions
DM/1.INF	July 2013	How to file an international application	 	
DM/1	December 2013	Application for international registration	  	E-Filing
DM/2	June 2013	Request for the recording of a change in ownership	  	
DM/3	December 2013	Request for the recording of a limitation	  	
DM/4	December 2013	Renewal of the international registration governed exclusively or partly by the 1999 Act and/or the 1960 Act	  	E-Renewal
DM/5	December 2013	Request for the recording of a renunciation	  	
DM/6	June 2013	Request for the recording of a change in name and/or address of the holder	  	
DM/7	January 2013	Appointment of a representative	  	
DM/8	January 2013	Request for the recording of a change in name and/or address of the representative	  	
DM/9	January 2013	Cancellation of recording of appointment of a representative	  	

# THE NATIONAL ROUTE VS. THE HAGUE ROUTE

- Several Offices for filing
  - Several application forms
  - Several languages
  - Several currencies
  - Several registrations
  - Several renewals
  - Several modifications
  - Foreign attorney needed from filing
- One Office for filing
  - One application form
  - One language (E/F/S)
  - One currency (CHF)
  - One international registration
  - One renewal
  - One modification
  - Foreign attorney first needed in case of refusal

# DESIGNS PER INTERNATIONAL REGISTRATION 2013

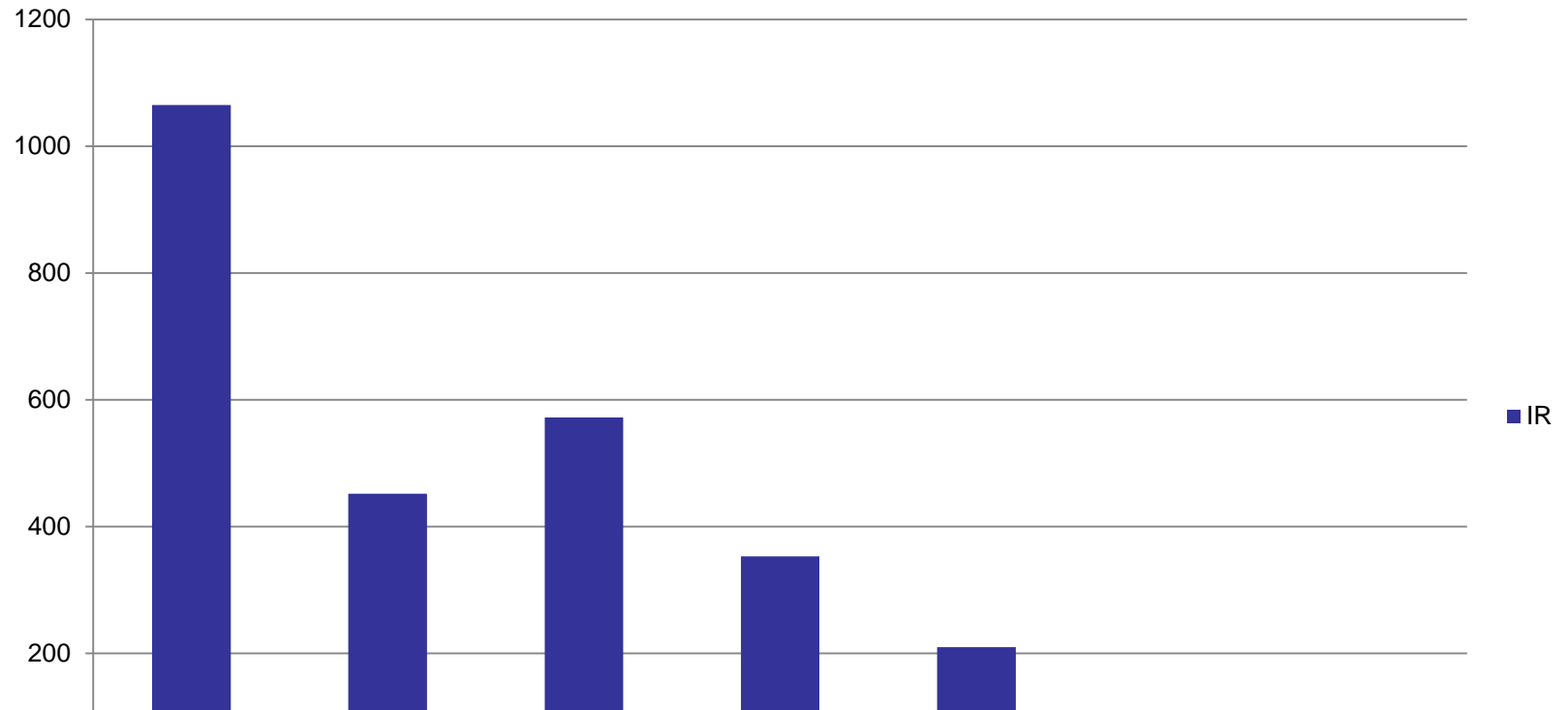

International Registrations	1065	452	572	353	210	59	23
%	39.0%	16.5%	20.9%	12.9%	7.7%	2.2%	0.8%

# AMOUNT OF FEES PAID PER INTERNATIONAL REGISTRATION 2013

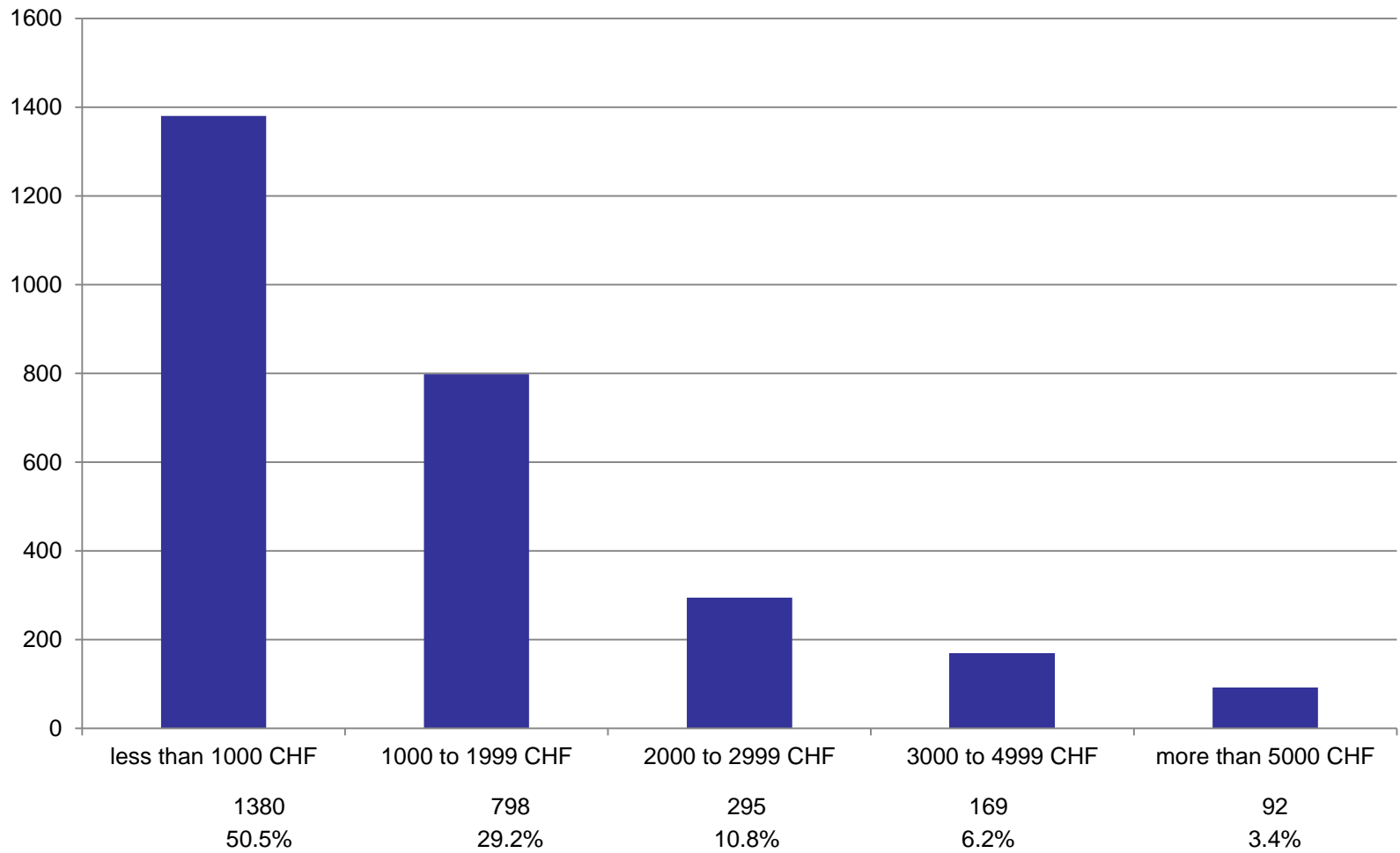

IR  
%



# DESIGNATIONS IN INTERNATIONAL REGISTRATION 2013

## Designations in IR

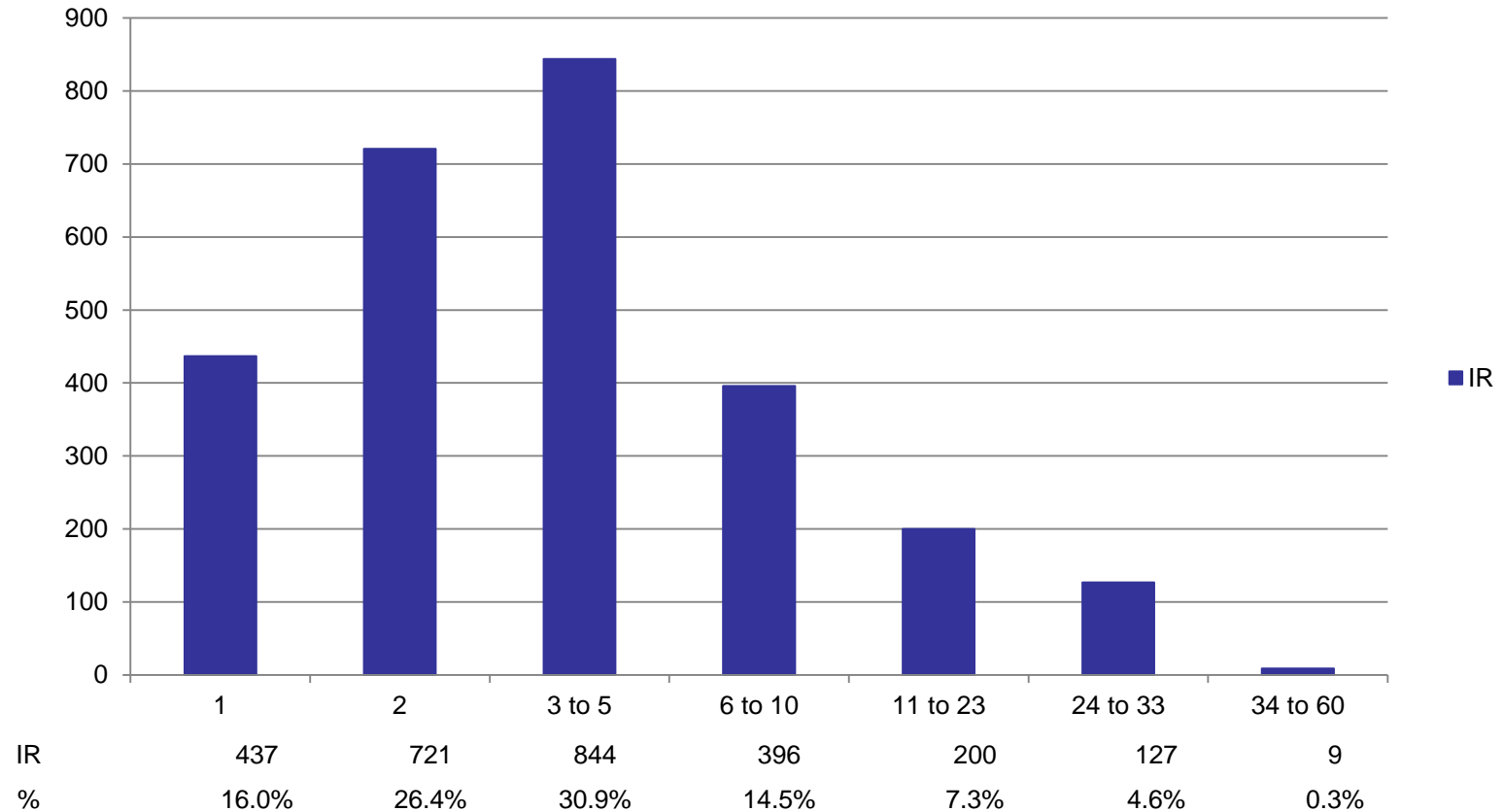

# ONLINE SERVICES / TOOLS

■ <http://www.wipo.int/hague/en/>

- E-Filing Portfolio Manager
- E-Renewal
- E-Payment
- Hague Express Database
- Fee calculator

# LATEST DEVELOPMENTS

- Weekly publication cycle since January 2012
  
- Enhancement of the **E-filing interface**
  - A WIPO User account
  
  - Facilitated downloading of reproductions
  
  - Automatic check and transformation of images
  
  - Integrated fee calculator
  
  - Payment of fees by credit card

# THE LISBON SYSTEM

# THE LISBON SYSTEM

- An international system that facilitates the protection of a special category of geographical indications, i.e. “appellations of origin”, in countries other than the country of origin
  
- Protection of national economic interests, in many countries, for goods bearing an appellation of origin

# LISBON UNION: 28 MEMBER STATES

## Africa (6)

Algeria  
Burkina Faso  
Congo  
Gabon  
Togo  
Tunisia

## Asia (3)

Iran (Islamic Rep. of)  
Israel  
Korea (DPR of)

## America (6)

Costa Rica  
Cuba  
Haiti  
Mexico  
Nicaragua  
Peru

## Europe (13)

Bosnia and Herzegovina  
Bulgaria  
Czech Rep.  
France  
Georgia  
Hungary  
Italy  
Moldova  
Montenegro  
Portugal  
Serbia  
Slovakia  
The FYR of Macedonia

Countries in red are post TRIPS accessions

# SEARCH APPELLATIONS OF ORIGIN LISBON EXPRESS

**Structured Search** options ▾ results ▾

» Search =

AND ▾ Number =

AND ▾ Appellation =

AND ▾ Country of Origin =

AND ▾ Area of Production =

AND ▾ Product =

AND ▾ Category =

AND ▾ Nice Classification =

AND ▾ Holder =

AND ▾ Date  All  From:

To:

AND ▾ Status by country =

■ Available at: <http://www.wipo.int/ipdl/en/search/lisbon/search-struct.jsp>

# THE BULLETIN “APPELLATIONS OF ORIGIN”

- The official publication of the Lisbon system for the publication of recordings in the International Register and information concerning changes in the legal framework.



- Available at: <http://www.wipo.int/lisbon/en/bulletin/>



# FORMS TO APPLY FOR AN INTERNATIONAL REGISTRATION OF APPELLATION OF ORIGIN

[\(http://www.wipo.int/lisbon/en/forms/\)](http://www.wipo.int/lisbon/en/forms/)

Reference	Description	Format
AO/1	Application for International Registration	<a href="#">DOC</a> <a href="#">PDF</a>
AO/4 (a)	Declaration of Refusal of Protection	<a href="#">DOC</a> <a href="#">PDF</a>
AO/5 (a)	Withdrawal of a Declaration of Refusal of Protection	<a href="#">DOC</a> <a href="#">PDF</a>
AO/8 (a)	Notification of Invalidation	<a href="#">DOC</a> <a href="#">PDF</a>
AO/9 (a)	Advice of Grant of a Period within which Use of an Appellation Must Be Discontinued	<a href="#">DOC</a> <a href="#">PDF</a>

# ON-GOING MULTILATERAL NEGOTIATIONS

## ■ WTO:

- establish a GI registry
- wine and spirits only or not ?

## ■ WIPO:

- working group to review Lisbon

# LISBON UNION ASSEMBLY (SEPTEMBER 2009)

- Mandated the Working Group on the Development of the Lisbon System to
  - look for improvements of the Lisbon system
  - so that it might attract a wider membership
  - while preserving the principles and objectives of the Lisbon Agreement

# TWO-FOLD MANDATE (LISBON UNION ASSEMBLY 2012)

## 1. Revision of the Lisbon Agreement

- Refinement and Modernization of the Legal Framework
- Accession Possibility for Intergovernmental Organizations (e.g., EU, OAPI)

## 2. Specifying its applicability to AOs and GIs

# DRAFT REVISED LISBON AGREEMENT

## MAIN PROVISIONS

- Definitions for GIs and AOs
- Procedures for international applications, refusals, invalidations, modifications, etc.
- Scope of protection
- How to deal with prior rights and prior use
- Option for registration of trans-border GIs and AOs
- Option for direct filings by beneficiaries
- Accession criteria for Intergovernmental Organizations (e.g., EU, OAPI)

# PROSPECTS

- Results 8th Session of the WG: December 2 to 6, 2013  
([http://www.wipo.int/meetings/en/details.jsp?meeting\\_id=31204](http://www.wipo.int/meetings/en/details.jsp?meeting_id=31204))
  - 9th Session: June 23 to 27, 2014
  - 10th Session: October 27 to 31, 2014, together with the Preparatory Committee
  
- Diplomatic Conference: Summer of 2015

Thank you  
for your attention

\*\*\*\*\*

Mrs. Asta Valdimarsdottir

Director

Operations Division

Madrid Registry, Brands and Designs Sector

World Intellectual Property Organization (WIPO)

Email: [Asta.valdimarsdottir@wipo.int](mailto:Asta.valdimarsdottir@wipo.int)



# ALTERNATIVE DISPUTE RESOLUTION- WIPO ARBITRATION AND MEDIATION CENTER



- Speaker: Víctor Vázquez, Head, Section for Coordination of Developed Countries, Department for Transition and Developed Countries (TDC), WIPO



# ALTERNATIVE DISPUTE RESOLUTION

- Procedure for settling disputes by means other than litigation (e.g. Arbitration, mediation or expert determination)
- The WIPO Arbitration and Mediation center was established in 1994
- Headquarters in Geneva with an office in Singapore

# MEDIATION, ARBITRATION, EXPERT DETERMINATION

- **Mediation:** an informal consensual procedure in which a neutral intermediary the mediator, assists the parties in reaching a settlement of their dispute, based on the parties' respective interests. The mediator cannot impose a decision. The settlement agreement has the force of a contract. Mediation leaves open all other dispute resolution options.
- **Arbitration:** A consensual procedure in which the parties submit their dispute to one or more chosen arbitrators, for a binding and final decision (award) based on the parties' respective rights and obligations and enforceable as an award under arbitral law. Arbitration constitutes a private alternative to court litigation.
- **Expert Determination:** A consensual procedure in which the parties submit a specific matter (e.g. technical question) to one or more experts who make a determination on the matter, which can be binding unless the parties have agreed otherwise

# WHY ADR FOR IP DISPUTES?

- Internationalization of creation/use of IP: cross-border solutions
- Technical and specialized nature of IP: specific expertise of the neutral
- Short product and market cycles: time-efficient procedures
- Confidential nature of IP: confidential procedures
- Collaborative nature of IP creation and commercialization: procedures that preserve relations
- Comprehensive solution to a plurality of disputes

# WIPO ARBITRATION AND MEDIATION CENTER

- ADR of IP Disputes requires a specialized, neutral and cost efficient provider
  - WIPO panel members experienced in IP and technology - able to deliver informed results efficiently
  - Very competitive WIPO fee structure
  - Status as international agency
  
- Services include mediation, (expedited) arbitration, expert determination
  - Parties can shape the process with the help of WIPO Rules, contract clauses
  - Active case management: time and cost
  - WIPO ECAF (online case management)
  - Procedural guidance, training programs

# WIPO ADR OPTIONS

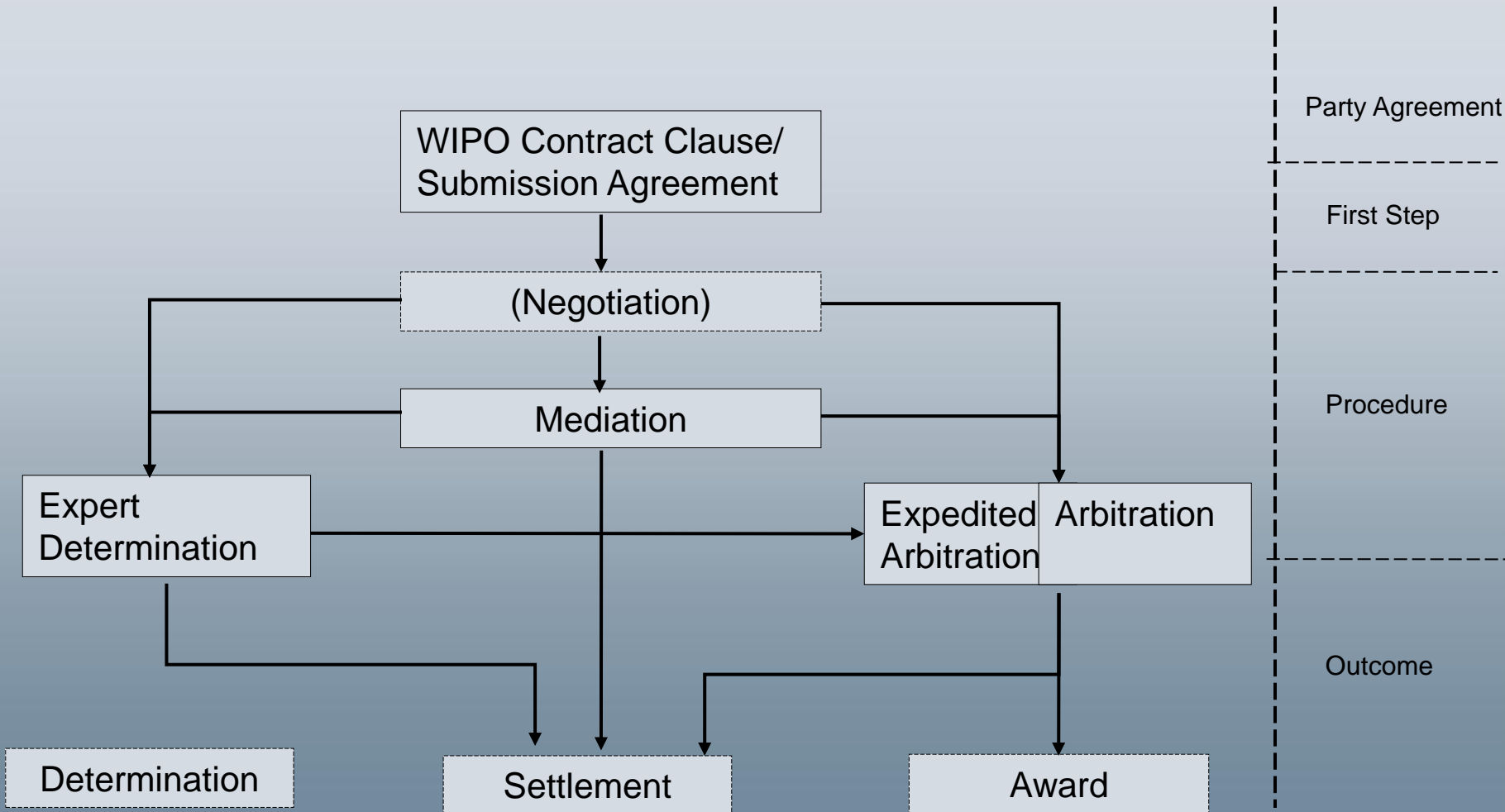

# WIPO SURVEY: INTERNATIONAL DIMENSION OF TECHNOLOGY DISPUTES

- 91% of respondents conclude agreements with **parties from other jurisdictions**
  
- +75% of respondents conclude agreements relating to technology protected **by patents in several countries**

# HOW ARE TECHNOLOGY DISPUTES RESOLVED ?

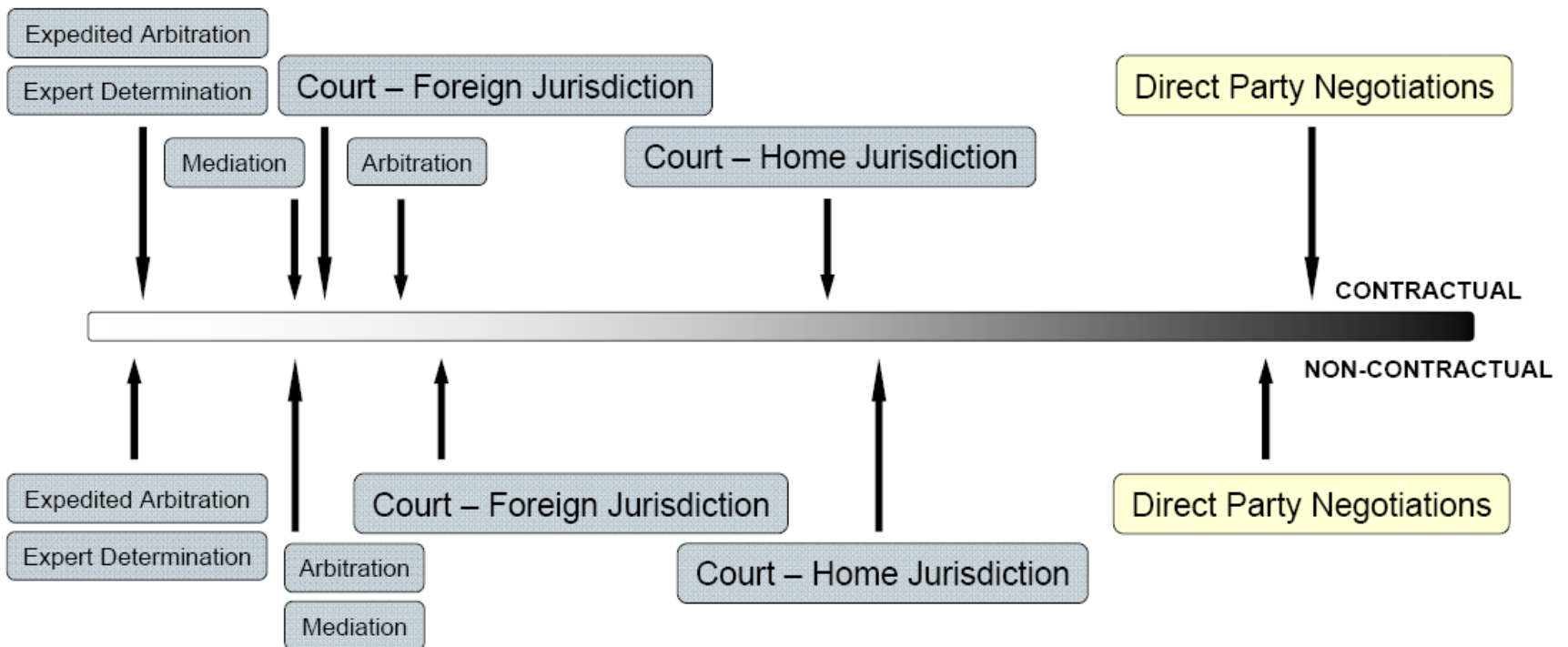

# RELATIVE TIME & COST OF TECHNOLOGY DISPUTE RESOLUTION

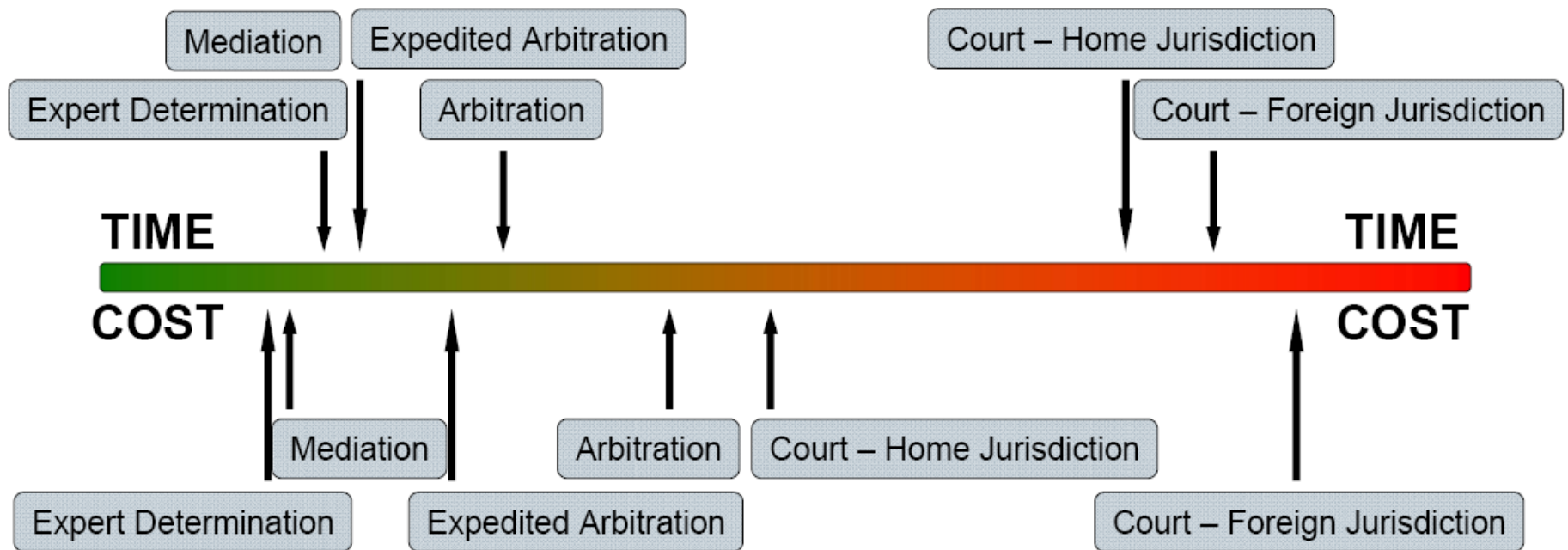



# AREAS OF WIPO CASES

- IP disputes and commercial disputes
- Contractual: patent licenses, software/IT, research and development agreements, patent pools, distribution agreements, joint ventures, copyright collecting societies, trademark coexistence agreements, settlement agreements
- Non-contractual (infringement of IP rights)
- Domestic and international disputes

# WIPO CASES: TYPES OF PROCEDURE

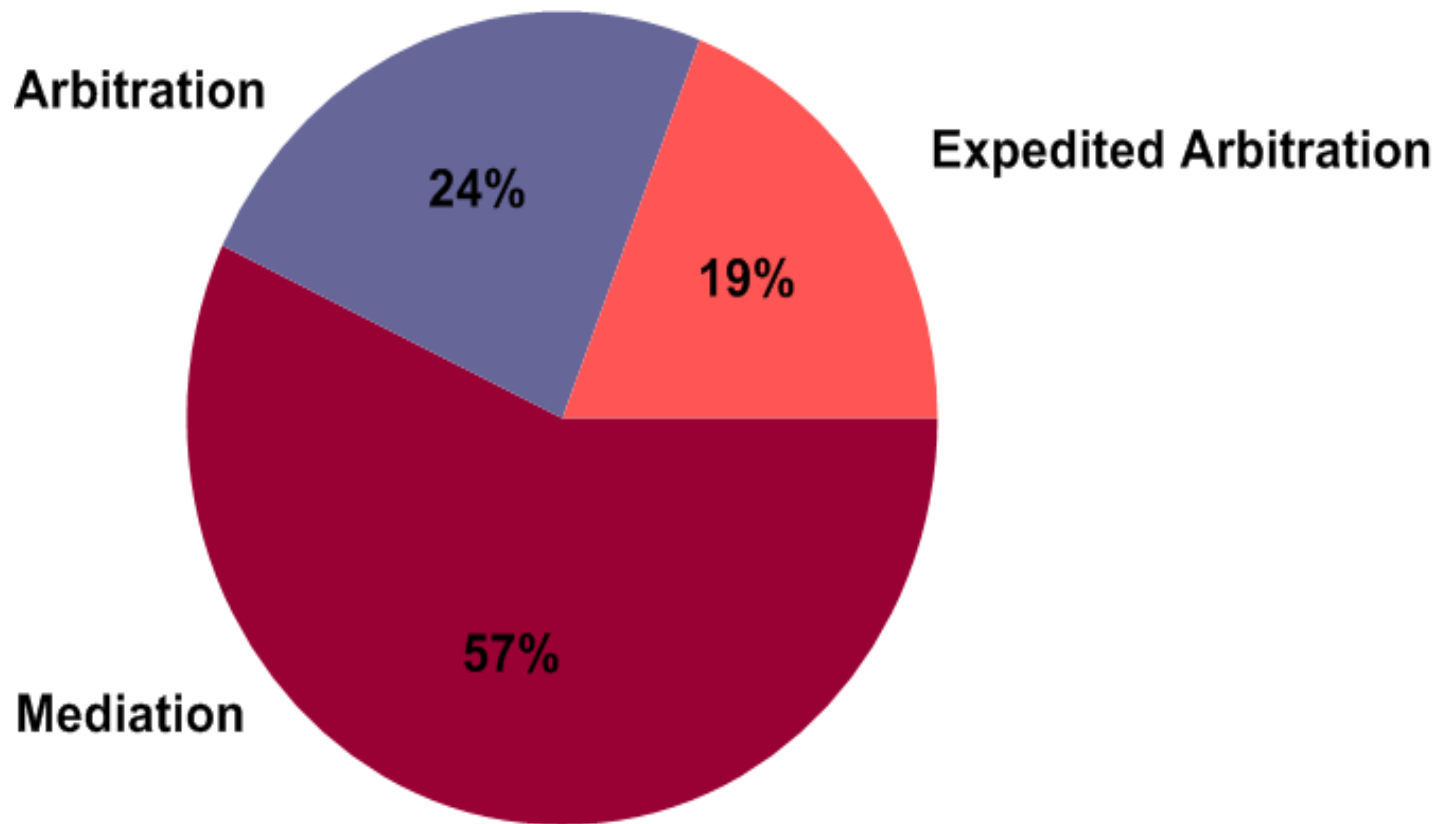

# WIPO CASES: SUBJECT MATTER

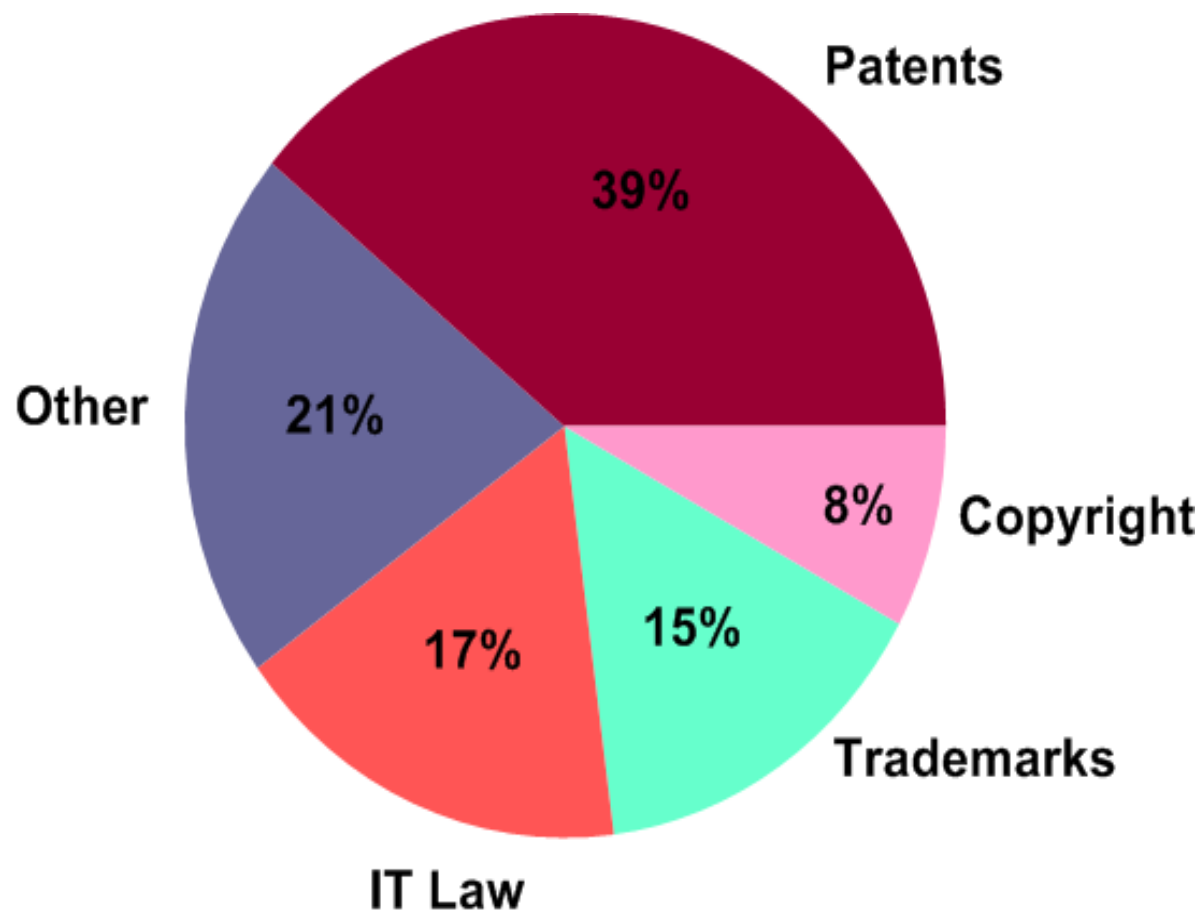

# WIPO CASES: BUSINESS AREAS

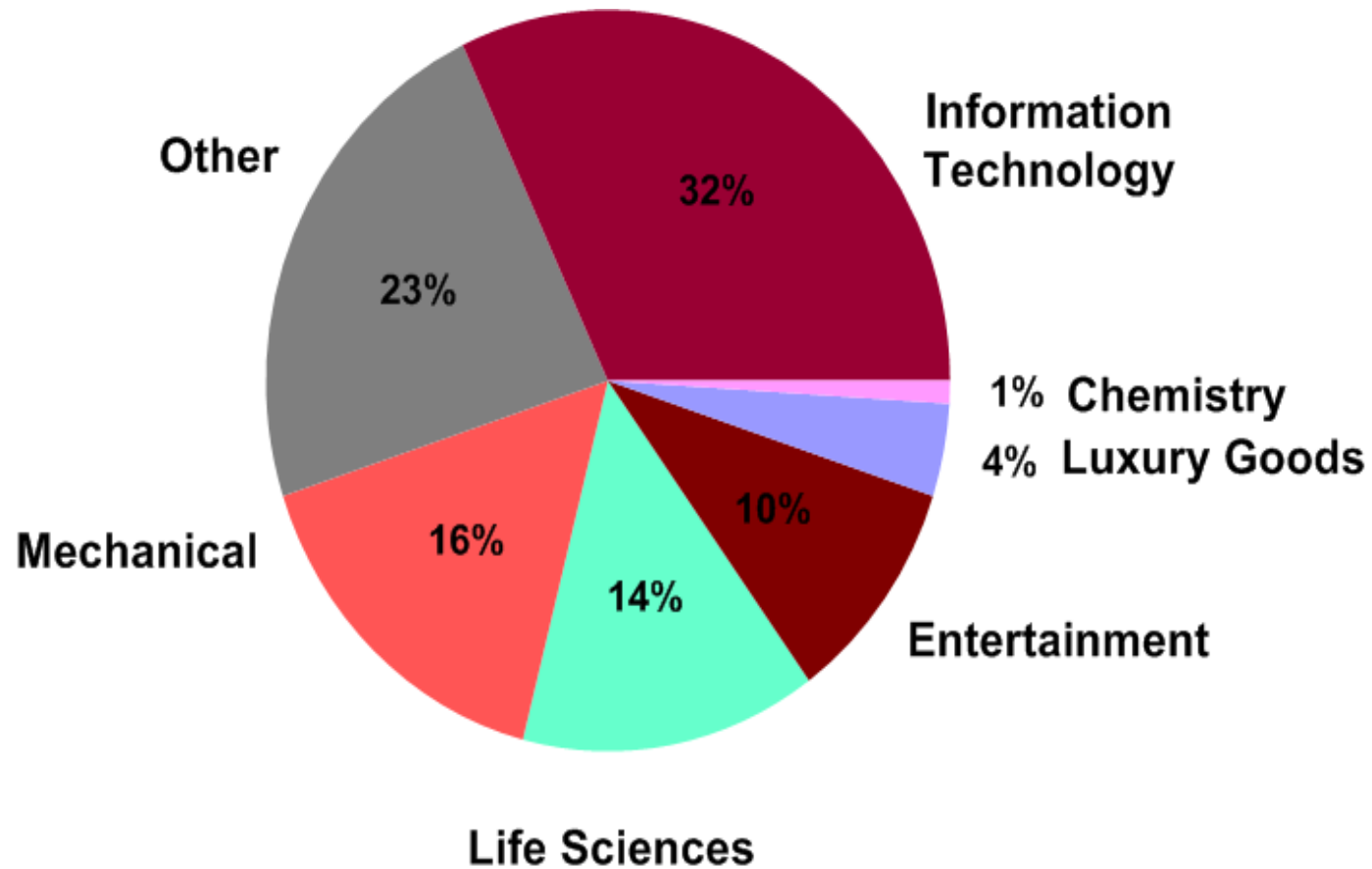

# DURATION OF MEDIATION AND ARBITRATION

## ■ MEDIATION

- Average duration: 8 months (46% of respondents: 1-6 months)
- WIPO cases: 5 months

## ■ ARBITRATION

- 6-12 months typically (61% of Respondents)

## ■ EXPEDITED ARBITRATION

- 9 months on average
- WIPO cases: expedited arbitration 7 months

# COSTS OF MEDIATION AND ARBITRATION

## ■ MEDIATION

- Costs below USD 100,000 (91% of Respondents)
- WIPO cases: average USD 21,000

## ■ ARBITRATION

- Average costs: USD 400,000 – USD 425,000

## ■ EXPEDITED ARBITRATION

- typically not more than USD 50,000

## ■ WIPO CASES: AVERAGE COSTS 165,000

# SETTLEMENT IN WIPO-ADMINISTERED CASES

## Mediation

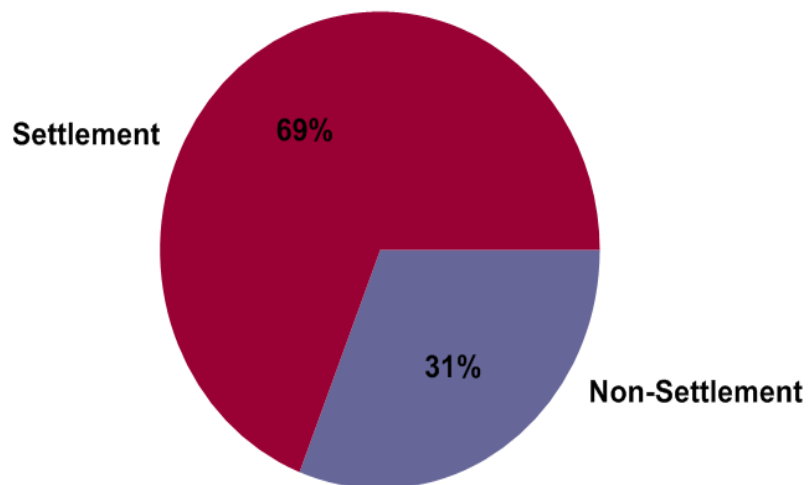

## Arbitration

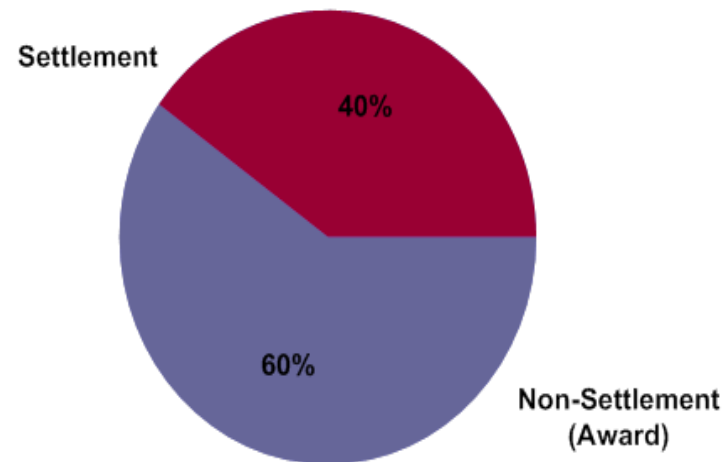

## WIPO ARBITRATION

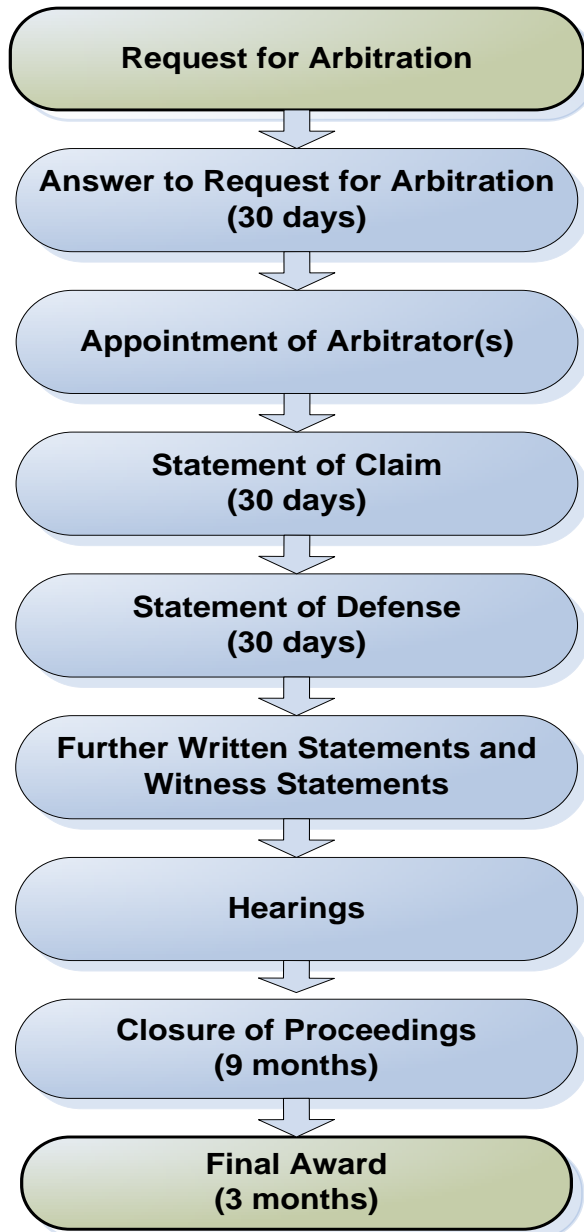

## WIPO EXPEDITED ARBITRATION

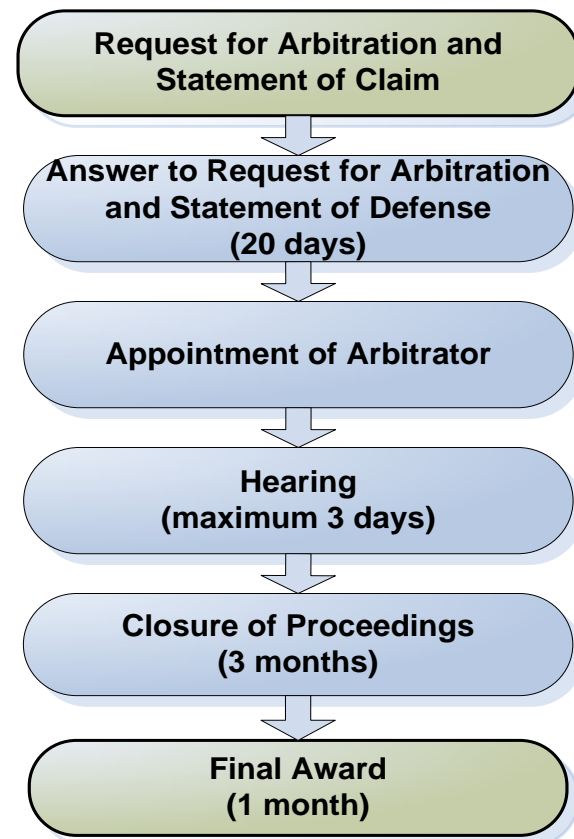

- One Exchange of Pleadings
- Shorter Time Limits
- Sole Arbitrator
- Shorter Hearings
- Fixed Fees



# WIPO MODEL CLAUSE – MEDIATION FOLLOWED BY ARBITRATION

## ■ Try mediation before arbitration, at least until

- lapse of time period
- Termination

## ■ Combining the benefits

- arbitration well-prepared

"Any dispute, controversy or claim arising under, out of or relating to this contract and any subsequent amendments of this contract, including, without limitation, its formation, validity, binding effect, interpretation, performance, breach or termination, as well as non-contractual claims, shall be submitted to mediation in accordance with the WIPO Mediation Rules. The place of mediation shall be [ ]. The language to be used in the mediation shall be [English]"

If, and to the extent that, any such dispute, controversy or claim has not been settled pursuant to the mediation within [60][90] days of the commencement of the mediation, it shall, upon the filing of a Request for Arbitration by either party, be referred to and finally determined by arbitration in accordance with the WIPO Arbitration Rules. Alternatively, if, before the expiration of the said period of [60][90] days, either party fails to participate or to continue to participate in the mediation, the dispute, controversy or claim shall, upon the filing of a Request for Arbitration by the other party, be referred to and finally determined by arbitration in accordance with the WIPO Arbitration Rules. The arbitral tribunal shall consist of [a sole arbitrator/three arbitrators]. The place of arbitration shall be [ ]. The language to be used in the arbitral proceedings shall be [English]. The dispute, controversy or claim referred to arbitration shall be decided in accordance with [ ] law."

# PATENT INFRINGEMENT DISPUTE SUBMITTED TO WIPO ARBITRATION

- Two U.S. companies, litigation in several jurisdictions
- Submission Agreement to WIPO Arbitration:
  - Patent infringement dispute related to a European patent in the area of consumer goods
  - Patent law of a particular European country applicable
  - Three-member arbitral tribunal
- WIPO Center suggested three arbitrators with expertise in the relevant national patent law
- One-day hearing including witness statements
- Final award rendered within five months of the commencement of the arbitration

# ACTIVE WIPO CASE MANAGEMENT

- General procedural information, training programs
- Initiation of procedure and subsequent case communication (option of WIPO Electronic Case Facility)
- Neutral appointment process
  - Over 1,500 specialized neutrals
  - 100 nationalities
  - Mediators, arbitrators, technical experts
  - All areas of IP/IT
  - New neutrals added in function of specific case needs
- Setting fees, financial management
- Availability of procedural guidance to neutral/ At request, hearing/meeting logistical assistance

# WIPO ELECTRONIC CASE FACILITY (ECAF)

- Easy; instant; centralized; location-independent; secure; available at parties' option

The screenshot displays the WIPO Electronic Case Facility (ECAF) interface. On the left, there is a navigation menu with links for ECAF HOME, Help, Arbitration, Mediation, Expert Determination, and Logout. The main content area is titled "WIPO Electronic Case Facility (ECAF)" and shows the case details for "Case: WIPOA20020" and "Licensing v. AB Technics Inc.". Below the case title, there are tabs for "Case Overview", "Contact Information", "Case File", "Message Board", and "Neutral Message Board". The "Case File" tab is active, showing instructions on how to submit documents and a table of submitted files. The table has columns for ITEM NO, SUBMITTED BY, DATE, SUBJECT, and ANNEX. The data in the table is as follows:

ITEM NO	SUBMITTED BY	DATE	SUBJECT	ANNEX
3	WIPO AMC Case Manager	04/08/09 14:44:26	<a href="#">Main Case File 3</a>	1 <a href="#">[ Add ]</a>
3.1		04/08/09 14:45:21	<a href="#">Annex 1</a>	<a href="#">[ Add ]</a>
2	WIPO AMC Case Manager	22/05/09 16:11:02	<a href="#">Main Case File 2</a>	2 <a href="#">[ Add ]</a>
2.1		22/05/09 16:11:22	<a href="#">Annex 1</a>	3 <a href="#">[ Add ]</a>
2.1.1		02/08/09 11:03:17	<a href="#">Annex 1</a>	
2.1.2		21/09/09 13:06:27	<a href="#">Annex 2</a>	

# WIPO ADR SERVICES FOR SPECIFIC SECTORS

- Domain Names (40,000+ cases since 1999)
- Research and Development/Technology Transfer
- ICT ( WIPO Arbitration for FRAND Disputes)
- Intellectual Property Offices :
  - IPO Singapore
  - INPI Brazil
- <http://www.wipo.int/amc/en/center/specific-sectors/>

# ADDITIONAL INFORMATION

■ Download more model clauses : <http://www.wipo.int/amc/en/clauses/>

■ Information on WIPO Rules, procedures, cases examples:

➤ <http://www.wipo.int/amc/en/>

■ Contact information:

➤ WIPO Center Office in Geneva  
WIPO Headquarters  
+41 22 338 8247

➤ WIPO Center Office in Singapore  
Maxwell Chambers  
+65 6225 2129

➤ [arbiter.mail@wipo.int](mailto:arbiter.mail@wipo.int)



**WIPO**  
WORLD  
INTELLECTUAL PROPERTY  
ORGANIZATION

# GLOBAL DATABASES FOR IP PLATFORMS AND TOOLS FOR THE CONNECTED KNOWLEDGE ECONOMY



**Speaker:** Glenn MacStravic, Head, Brand Database Section, Global Infrastructure Sector (GIS), WIPO

# STRATEGIC GOALS OF GLOBAL DATABASES AND TOOLS

■ 2 related goals:

- “Coordination and Development of Global IP Infrastructure”
- “World Reference Source for IP Information and Analysis”



# BENEFITS TO STAKEHOLDERS

## ■ For Business/Research:

- Providing search facilities for IP collections (patents, trademarks, industrial designs)
- Simplifying application procedures to multiple IP authorities
- Providing IP related matchmaking services

## ■ For IP offices:

- Assisting automation, IP information dissemination to the public, and exchange of IP documents with other offices

# GLOBAL DATABASES, TOOLS, AND PLATFORMS FOR IP BUSINESS (FREE)

- PATENTSCOPE
- Global Brand Database
- WIPO Lex
- WIPO IPAS, WIPO DAS
- WIPO CASE
- WIPO RE:SEARCH
- WIPO GREEN

# PATENTSCOPE

- 2.4 million PCT data (first publish every week, high quality full text)
- 35 million records from 36 countries or regions
- Full text data from 18 countries or regions
- 15,000 pageviews per hour
- Analyze results by graphs and charts
- Search and read in your language

How to use it?

WIPO is the global forum for intellectual property services, policy, information and cooperation.

## We deliver global services for protecting IP

File, manage or search patents, trademarks, designs and appellations of origin. Not there yet? Learn all about intellectual property and how to protect it.

### WIPO | PCT

The International Patent System

### WIPO | MADRID

The International Trademark System

### WIPO | HAGUE

The International Design System

## Alternative dispute resolution

Settle IP and technology disputes out of court using the fast, flexible and cost-effective services offered by the WIPO Arbitration and Mediation Center.

## Domain name disputes

Resolve cybersquatting and other disputes relating to trademark domain names.

## We shape international IP rules for a changing world

Follow policy discussions and negotiations on the future development of IP in our standing committees and meetings.

## Next meetings

Standing Committee on the Law of Patents

Jan 27–31

Intergovernmental Committee on IP and Genetic Resources, Traditional Knowledge and Folklore

Feb 3–7

[All upcoming meetings](#)

FEATURED

## WIPO Assemblies

The **52nd Series of Meetings of the Assemblies** of the Member States of WIPO took place in Geneva from December 10 to 12, 2013.

- [Documents](#) | [Videos on demand](#)

## We provide access to the world's IP information

Search technology and brand-related information in our free global databases. Download our other reference materials: publications, statistics, economic studies and more.

### PATENTSCOPE

35 million international and national patent documents

### Global Brand Database

11 million international and national records of trademarks, appellations of origin and emblems

### ROMARIN

International marks recorded under the Madrid System

### WIPO Lex

IP laws and treaties

FEATURED

## World IP Indicators

Latest statistical report shows IP filing activity is extending its run of pre-crisis level growth.

[Download the full Report](#)



## PATENTSCOPE

The PATENTSCOPE database provides access to international Patent Cooperation Treaty applications in full text format on the day of publication. The information may be searched by entering keywords, names of applicants, international patent classification and many other search criteria in multiple languages.

[Access the PATENTSCOPE database](#)



### Resources

- [Translation assistant](#)
- [Data services](#)
- [External databases](#)
- [Webinars](#)
- [Frequently asked questions](#)
- [Forum](#)

**News** [Revised terms and conditions for the use of PCT data products and services](#) Jan 7, 2014 | [National collection of Canada now available](#) Dec 18, 2013

[All news](#)

## Projects and studies

### Patent legal status

WIPO activities for improving worldwide availability, reliability and comparability of patent legal status data, e.g. to further develop patent legal status databases and widen the participation of countries in data sharing.

### Patent landscapes

WIPO reports in areas of particular interest to developing and least developed countries, such as public health, food security, climate change and environment.

## Publications



### PATENTSCOPE Search and CLIR

[Download](#)



### Finding Technology using Patents

[Download](#)

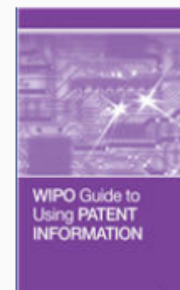

### WIPO Guide to using Patent Information

[Download](#)



# PATENTSCOPE

Mobile | Deutsch | Español | Français | 日本語 | 한국어 | Português | Русский | 中文

Search International and National Patent Collections

WORLD INTELLECTUAL PROPERTY ORGANIZATION

**Search** | Browse | Translate | Options | News | Login | Help

- Simple
- Advanced Search
- Field Combination
- Cross Lingual Expansion

35 million patent documents including 2.2 million published international patent applications (PCT).  
found here (->)

Front Page

Office: All

Search

Input search terms

Query

[\[Help\]](#)

electric car

» Query Language: English

» Expansion Mode: Automatic

» Precision  Recall

Submit Query

Electric car only 16,000 hits

Search Query (synonyms & technologically related terms)

Results 1-10 of 153,538 for Criteria: (EN\_TI:(("electric car" OR "electric vehicle" OR "electrical motor" OR "hybrid car" OR "electric vehicular"~21 OR "electric automobile"~21) OR EN\_AB:(("electric car" OR "electric vehicle" OR "electrical motor" OR "hybrid car" OR "electric vehicular"~21 OR "electric automobile"~21) OR (DE\_TI:(("Elektrofahrzeuge" OR "Elektroauto" OR "Elektromotoren" OR "Elektroautos" OR "Hybridfahrzeug" OR "Hybridautomobil" OR "elektrisches Fahrzeug") OR DE\_AB:(("Elektrofahrzeug" OR "Elektroauto" OR "Elektromotoren" OR "Elektroautos" OR "Hybridfahrzeug" OR "Hybridautomobil" OR "elektrisches Fahrzeug")) OR (ES\_TI:(("vehículo eléctrico" OR "motor eléctrico" OR "vagón eléctrico" OR "coche eléctrico" OR "carro eléctrico" OR "automóvil eléctrico" OR "vehículo híbrido") OR ES\_AB:(("vehículo eléctrico" OR "motor eléctrico" OR "vagón eléctrico" OR "coche eléctrico" OR "carro eléctrico" OR "automóvil eléctrico" OR "vehículo híbrido") OR (FR\_TI:(("véhicule électrique" OR "voiture électrique" OR "auto électrique" OR "moteur électrique" OR "véhicule hybride" OR "voiture hybride") OR FR\_AB:(("véhicule électrique" OR "voiture électrique" OR "auto électrique" OR "moteur électrique" OR "véhicule hybride" OR "voiture hybride")) OR (JA\_TI:(("電動車両" OR "電気自動車" OR "ハイブリッド自動車" OR "ハイブリッドカー" OR "電気車" OR "ハイブリッド車" OR "ハイブリッドカー") OR JA\_AB:(("電動車両" OR "電気自動車" OR "ハイブリッド自動車" OR "ハイブリッドカー" OR "電気車" OR "ハイブリッド車" OR "ハイブリッドカー") OR (KO\_TI:(("전기자동차" OR "전기 차량" OR "전동 차량" OR "전기차" OR "차량의제어" OR "하이브리드 자동차와아이" OR "전기 모터 제어" OR "전기 모터" OR "하이브리드 자동차용") OR KO\_AB:(("전기자동차" OR "전기 차량" OR "전동 차량" OR "전기차" OR "차량의제어" OR "하이브리드 자동차와아이" OR "전기 모터 제어" OR "전기 모터" OR "하이브리드 자동차용")) OR (PT\_TI:(("veículo elétrico" OR "veículo eléctrico" OR "automóvil eléctrico" OR "veículo elétrico" OR "motor eléctrico") OR PT\_AB:(("veículo elétrico" OR "veículo eléctrico" OR "automóvil eléctrico" OR "veículo elétrico" OR "motor eléctrico")) OR (RU\_TI:(("электрической автомобиля"~22 OR "электрической средства"~22 OR "электрической вагона"~22 OR "электроподвижного автомобиля"~22 OR "электроподвижного транспортных средств"~22 OR "электроподвижного средства"~22 OR "электроподвижного вагона"~22 OR "электротранспорта") OR RU\_AB:(("электрической автомобиля"~22 OR "электрической транспортных средств"~22 OR "электрической средства"~22 OR "электрической вагона"~22 OR "электроподвижного автомобиля"~22 OR "электроподвижного транспортных средств"~22 OR "электроподвижного средства"~22 OR "электроподвижного вагона"~22 OR "электротранспорта")) OR (ZH\_TI:(("电车" OR "电动车辆" OR "电动汽车" OR "电动机动" OR "用于电动机动" OR "混合动力汽车" OR "混合动力车发电") OR ZH\_AB:(("电车" OR "电动车辆" OR "电动汽车" OR "电动机动" OR "用于电动机动" OR "混合动力汽车" OR "混合动力车发电")) Office(s):all Language:EN Stemming: true

prev 1 2 3 4 5 6 7 8 9 10 next Page:1 / 15354 Go >

Refine Search Search RSS

Analysis

Sort by: Relevance View All List Length 10

No	Ctr	Title	PubDate	Int.Class	Appl.No	Applicant	Inventor
1.	WO	WO/2012/167518 - SOLAR HYBRID VEHICLE	13.12.2012	B60K 6/28	PCT/CN2011/079446	ZHU, Shuyi	ZHU, Shuyi

A solar hybrid vehicle comprises a vehicle body, a vehicle energy configuration system, and a braking energy recycling device (11). The vehicle body collects solar energy with a solar energy collection system, the collected solar energy is stored in the vehicle energy configuration system, and the braking energy recycling device is connected to a storage battery pack (6). A power is disposed between the vehicle energy configuration system and the storage battery pack. The vehicle







1. (WO2012167518) SOLAR HYBRID VEHICLE

- PCT Biblio. Data
- Description
- Claims
- National Phase
- Notices
- Drawings
- Documents

Latest bibliographic data on file with the International Bureau

PermaLink

Pub. No.: WO/2012/167518 International Application No.: PCT/CN2011/079446  
 Publication Date: 13.12.2012 International Filing Date: 07.09.2011  
 IPC: B60K 6/28 (2007.10), B60L 8/00 (2006.01)   
 Applicants: ZHU, Shuyi [CN/CN]; (CN)  
 Inventors: ZHU, Shuyi; (CN)  
 Agent: BEIJING GENIUS ESSEN INTELLECTUAL PROPERTY OFFICE; Room 806 ~ 809 Taifeng Huizhong Mansion No.120 Zhushikou W. St., Xicheng District Beijing 100050 (CN)

Priority Data: 201110151619.9 08.06.2011 CN

Title  
 (EN) SOLAR HYBRID VEHICLE  
 (FR) VÉHICULE HYBRIDE SOLAIRE  
 (ZH) 太阳能混合动力汽车

Abstract: (EN) A solar hybrid vehicle comprises a vehicle body, a vehicle energy configuration system, and a braking energy recycling device (11). The vehicle body collects solar energy with a solar energy collection system, the collected solar energy is stored in the vehicle energy configuration system, and the braking energy recycling device is connected to a storage battery pack (6). A sensor is disposed between the vehicle energy configuration system and the storage battery pack. The vehicle energy configuration system is connected to an on-board automatic control system, an external charging interface (15) and an electric motor (7). The present invention combines multiple technical solutions, reduces energy consumption, increases the utilization of solar energy, and is more aesthetic and user-friendly.



图 1 / Fig. 1

(FR) La présente invention concerne un véhicule hybride solaire comportant une carrosserie de véhicule, un système de configuration d'énergie de véhicule, et un dispositif de recyclage d'énergie au freinage (11). La carrosserie de véhicule collecte de l'énergie solaire grâce à un système de collecte d'énergie solaire, l'énergie collectée est stockée dans le système de configuration d'énergie de véhicule et le dispositif de recyclage d'énergie au freinage est connecté à un bloc d'éléments d'accumulateur (6). Un capteur est disposé entre le système de configuration d'énergie de véhicule et le bloc d'éléments d'accumulateur. Le système de configuration d'énergie de véhicule est connecté à un système de commande automatique embarqué, à une interface de charge externe (15) et à un moteur électrique (7). La présente invention est une combinaison de plusieurs solutions techniques, réduit la consommation d'énergie, accroît l'utilisation de l'énergie solaire, et est plus esthétique et conviviale.

(ZH) 一种太阳能混合动力汽车, 包含汽车本体、车体能量配置系统、制动能量回收装置 (11); 汽车本体通过太阳能采集系统收集太阳能, 收集的太阳能存储在车体能量配置系统中, 制动能量回收装置与蓄



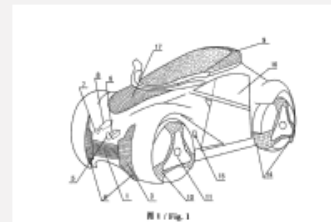

1. (WO2012167518) SOLAR HYBRID VEHICLE

PCT Biblio. Data

Description

Claims

National Phase

Notices

Drawings

Documents

Note: Text based on automatic Optical Character Recognition processes. Please use the PDF version for legal matters

 Machine translation

太阳能混合动力汽车

技术领域

本发明涉及一种太阳能混合动力汽车，属于新能源汽车技术领域。

背景技术

随着国民经济的快速发展，越来越多的家庭已经或即将拥有汽车。但是，国际原油价格的一路飙升为我们敲响了能源紧缺的警钟。汽车在中国家庭中的普及要求我们在新能源汽车上取得实质性的技术突破。

目前，国内外众多科研机构、公司都在致力于新能源汽车的研究。其中，混合动力汽车是现有新能源汽车中最接近成熟的产品。混合动力汽车的性能可以超过传统的燃油汽车，但其电池蓄电量成为影响其发展的瓶颈，所以还不能完全取代燃油汽车。

在太阳能汽车的开发研究上，人们已经取得了较大的进展。近年来对太阳能收集转化技术的研究，也有效提高了太阳能的吸收利用率。太阳能汽车的车体玻璃对太阳能的有效吸收利用情况在很大程度上影响了汽车的整体性能。为此，人们在太阳能汽车上尝试使用可烘烤低辐射镀膜玻璃和太阳能薄膜电池来提高太阳能的吸收效率，并取得了一定的效果。

因此，借助技术的更新可以为市场提供更好的节能环保型太阳能混合动力汽车。

发明内容

本发明所要解决的技术问题在于克服现有技术的不足，提供一种太阳能混合动力汽车。

为实现上述的发明目的，本发明采用下述的技术方案：

一种太阳能混合动力汽车，包括汽车本体、太阳能采集系统、车体能量配置系统、车载自动控制系统和制动能量回收装置；

所述汽车本体通过所述太阳能采集系统收集太阳能；收集的太阳能储存在车体能量配置系统中，所述制动能量回收装置与蓄电池组连接；所述车体能量配置系统与所述蓄电池组之间设有传感器，所述车体能量配置系统分别与所述车载自动控制系统、外接充电接口和电动机相连；

所述太阳能采集系统包括太阳能天窗、可烘烤低辐射镀膜玻璃、太阳能薄膜电池以及车轮太阳能板，其中所述太阳能天窗为设置在所述汽车本体顶部的太阳能蜂窝吸光体；

在所述车体能量配置系统中，供电控制单元分别与光强检测单元、太阳能采集单元、能量存储单元、汽车用电单元连接，用于实时接收所述光强检测单元检测到的光强信号，并根据该光强信号控制所述太阳能采集单元、所述能量存储单元以及所述汽车用电单元的运行；

在所述汽车本体的车轮外侧分别设置有磁浮制动盘罩，所述磁浮制动盘罩的表面设置有车轮太阳能板；



1. (WO2012167518) SOLAR HYBRID VEHICLE

PCT Biblio. Data

Description

Claims

National Phase

Notices

Drawings

Documents

Note: Text based on automatic Optical Character Recognition processes. Please use the PDF version for legal matters

Select Language

Alternative machine translation: (microsoft)

Powered by Google Translate

太阳能混合动力汽车

技术领域

本发明涉及一种太阳能混合动力汽车，属于新能源汽车技术领域。

背景技术

随着国民经济的快速发展，越来越多的家庭已经或即将拥有汽车。但是，国际原油价格的一路飙升为我们敲响了能源紧缺的警钟。汽车在中国家庭中的普及要求我们在新能源汽车上取得实质性的技术突破。

目前，国内外众多科研机构、公司都在致力于新能源汽车的研究。其中，混合动力汽车是现有新能源汽车中最接近成熟的产品。混合动力汽车的性能可以超过传统的燃油汽车，但其电池蓄电量成为影响其发展的瓶颈，所以还不能完全取代燃油汽车。

在太阳能汽车的开发研究上，人们已经取得了较大的进展。近年来对太阳能收集转化技术的研究，也有效提高了太阳能的吸收利用率。太阳能汽车的车体玻璃对太阳能的有效吸收利用情况在很大程度上影响了汽车的整体性能。为此，人们在太阳能汽车上尝试使用可烘弯低辐射镀膜玻璃和太阳能薄膜电池来提高太阳能的吸收效率，并取得了一定的效果。

因此，借助技术的更新可以为市场提供更好的节能环保型太阳能混合动力汽车。

发明内容

本发明所要解决的技术问题在于克服现有技术的不足，提供一种太阳能混合动力汽车。

为实现上述的发明目的，本发明采用下述的技术方案：

一种太阳能混合动力汽车，包括汽车本体、太阳能采集系统、车体能量配置系统、车载自动控制系统和制动能量回收装置；

所述汽车本体通过所述太阳能采集系统收集太阳能；收集的太阳能储存在车体能量配置系统中，所述制动能量回收装置与蓄电池组连接；所述车体能量配置系统与所述蓄电池组之间设有传感器，所述车体能量配置系统分别与所述车载自动控制系统、外接充电接口和电动机相连；

所述太阳能采集系统包括太阳能天窗、可烘弯低辐射镀膜玻璃、太阳能薄膜电池以及车轮太阳能板，其中所述太阳能天窗为设置在所述汽车本体顶部的太阳能蜂窝吸光体；

在所述车体能量配置系统中，供电控制单元分别与光强检测单元、太阳能采集单元、能量存储单元、汽车用电单元连接，用于实时接收所述光强检测单元检测到的光强信号，并根据该光强信号控制所述太阳能采集单元、所述能量存储单元以及所述汽车用电单元的运行；

在所述汽车本体的车轮外侧分别设置有磁浮制动盘罩，所述磁浮制动盘罩的表面设置有车轮太阳能板；



## 1. (WO2012167518) SOLAR veículo híbrido

[PCT Biblio. Dados](#)[Descrição](#)[Reivindicações](#)[Fase Nacional](#)[Avisos](#)[Desenhos](#)[Documentos](#)

**Nota:** Texto baseado em processos de reconhecimento óptico de caracteres automática. Por favor, use a versão em PDF para assuntos jurídicos

Portugais

Fourni par [Google Traduction](#)  
[detail.jsfDescription](#)

Alternative machine translation: (microsoft)

**Query**

FP:(WO2012167518)



Carros híbridos solares

Campo técnico

A presente invenção refere-se a um veículo híbrido solar, que pertence ao domínio da nova tecnologia automóvel energia.

**JUSTIFICATIVA**

Com o rápido desenvolvimento da economia nacional, mais e mais famílias foram ou estão prestes a ter um carro. No entanto, os preços internacionais do petróleo subindo escassez de energia para nós soou o alarme. Automotive popular na China a família pediu-nos para conseguir avanços substanciais em veículos de energia nova.

Atualmente, muitas instituições de pesquisa nacionais e estrangeiras, empresas estão trabalhando em veículos de energia nova. Entre eles, o carro híbrido é o mais próximo de novos produtos automotivos existentes energia maduros. Os carros híbridos podem exceder o desempenho de veículos movidos a combustíveis tradicionais, mas a sua capacidade de bateria se torna um gargalo que afeta o seu desenvolvimento, por isso não pode substituir completamente os veículos de combustível.

Na pesquisa e desenvolvimento de carros solares, as pessoas têm feito grandes progressos. Estudos recentes sobre a conversão da tecnologia de coleta de energia solar, mas também efetivamente melhorar a absorção e utilização de energia solar. So carro para absorver de forma eficaz a energia solar é amplamente afetado o desempenho global da utilização do carro. pessoas tentam usar o carro solar pode assar curva vidro low-E e as células solares de película fina para melhorar a e de energia solar, e alcançou alguns resultados.

What if you do not know a term in English?

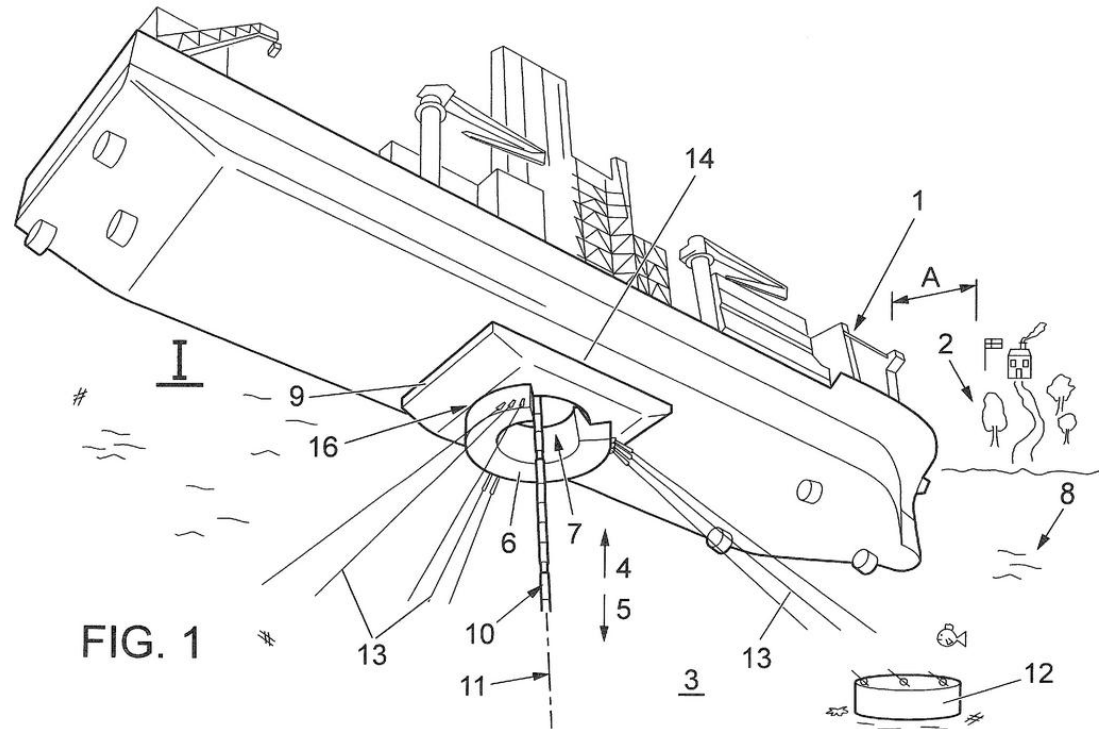
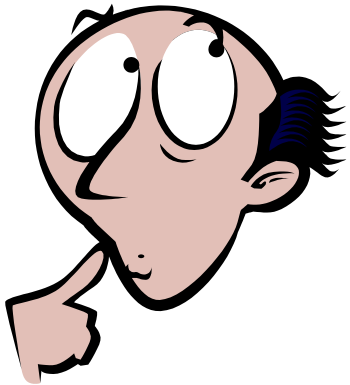



# PATENTSCOPE

Mobile | Deutsch | Español | Français | 日本語 | 한국어 | Português | Русский | 中文

Search International and National Patent Collections

WORLD INTELLECTUAL PROPERTY ORGANIZATION

Search

Browse

Translate

Options

News

Login

Help

Home > IP Services > PATENTSCOPE Home > IP Services > PATENTSCOPE

Input search terms

[Help]

Query

atracação navios

Query Language: Portuguese

Expansion Mode:

Precision

0

4

Recall

Submit Query

- English
- French
- German
- Spanish
- Portuguese
- Japanese
- Russian
- Chinese
- Korean
- Italian
- Swedish
- Dutch



# PATENTSCOPE

Mobile | Deutsch | Español | Français | 日本語 | 한국어 | Português | Русский | 中文

Search International and National Patent Collections

WORLD INTELLECTUAL PROPERTY ORGANIZATION

Search

Browse

Translate

Options

News

Login

Help

Home > IP Services > PATENTSCOPE Home > IP Services > PATENTSCOPE

Input search terms

[Help]

Query

atracação navios

Query Language: Portuguese

Expansion Mode: Automatic

Precision

0

4

Recall

Submit Query

Input search terms

Query Domains [MARI] [Help]

<ul style="list-style-type: none"> <li>[ADMN] Admin, Business, Management &amp; Soc Sci</li> <li>[AERO] Aeronautics &amp; Aerospace Engineering</li> <li>[AGR] Agriculture, Fisheries &amp; Forestry</li> <li>[AUDV] Audio, Audiovisual, Image &amp; Video Tech</li> <li>[AUTO] Automotive &amp; Road Vehicle Engineering</li> <li>[BLDG] Civil Engineering &amp; Building Construction</li> <li>[CHEM] Chemical &amp; Materials Technology</li> <li>[DATA] Computer Sci, Telecom &amp; Broadcasting</li> <li>[ELEC] Electrical Engineering &amp; Electronics</li> <li>[ENGY] Energy, Fuels &amp; Heat Transfer Eng</li> <li>[ENVR] Environmental &amp; Safety Engineering</li> <li>[FOOD] Foods &amp; Food Technology</li> <li>[GENR] Generalities, Language, Media &amp; Info Sci</li> <li>[HOME] Home Contents &amp; Household Maintenance</li> <li>[HORO] Precision Mechanics, Jewelry &amp; Horology</li> <li>[MANU] Manufacturing &amp; Materials Handling Tech</li> <li>[MEAS] Standards, Units, Metrology &amp; Testing</li> <li>[MECH] Mechanical Engineering</li> <li>[MED] Medical Technology</li> <li>[METL] Metallurgy</li> <li>[MIL] Military Technology</li> <li>[MINE] Mining, Oil &amp; Gas Extraction &amp; Minerals</li> <li>[NANO] Nano Technology</li> <li>[PACK] Packaging &amp; Distribution of Goods</li> <li>[PRNT] Printing &amp; Paper</li> <li>[RAIL] Railway Engineering</li> <li>[SCIE] Optical Engineering</li> <li>[SPRT] Sports, Leisure, Tourism &amp; Hospitality Ind</li> <li>[TEXT] Textile &amp; Clothing Industries</li> <li>[TRAN] Transportation</li> </ul>	<p>Add &gt;&gt;</p> <p>&lt;&lt; Remove</p>	<p>[MARI] Marine Engineering</p>
--	--	----------------------------------

Expand Synonyms >



Home > IP Services > PATENTSCOPE Home > IP Services > PATENTSCOPE

## Input search terms

Term 1: atracação

[\[Help\]](#)

Variants

Domains [MAR]

Keep term untranslated when expanding query in other languages

Less

0

4

More

ancoragem

amarração

Add Variant

Term 2: navios

Translate Selected Terms

Back

Start Over

Home > IP Services > PATENTSCOPE Home > IP Services > PATENTSCOPE

Input search terms

Term 1: atracação

Term 2: navios

[\[Help\]](#)

[Variants](#)

[Domains \[MAR\]](#)

Keep term untranslated when expanding query in other languages

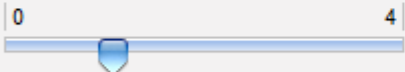
Less | 0 |  | 4 | More

embarcação

[Add Variant](#)

[Translate Selected Terms](#)

[Back](#)

[Start Over](#)



# PATENTSCOPE

[Mobile](#) | [Deutsch](#) | [Español](#) | [Français](#) | [日本語](#) | [한국어](#) | [Português](#) | [Русский](#) | [中文](#) |

Search International and National Patent Collections

WORLD INTELLECTUAL PROPERTY ORGANIZATION

[Search](#)

[Browse](#)

[Translate](#)

[Options](#)

[News](#)

[Login](#)

[Help](#)

[Home](#) > [IP Services](#) > [PATENTSCOPE Home](#) > [IP Services](#) > [PATENTSCOPE](#)

[\[Help\]](#)

[Portuguese](#)  [German](#)  [English](#)  [Spanish](#)  [French](#)  [Italian](#)  [Japanese](#)  [Korean](#)  [Dutch](#)  [Russian](#)   
[Swedish](#)  [Chinese](#)  [IPC](#)

(( anchoring OR mooring OR docking ) AND ( vessel OR ships OR boat ) )

Field(s) you want to search:

Abstract

Acceptable distance between matched words:

Unconstrained

Stemming

[Submit Query](#)

[Back](#)

[Start Over](#)



# PATENTSCOPE

[Mobile](#) | [Deutsch](#) | [Español](#) | [Français](#) | [日本語](#) | [한국어](#) | [Português](#) | [Русский](#) | [中文](#)

Search International and National Patent Collections

WORLD INTELLECTUAL PROPERTY ORGANIZATION

[Search](#)

[Browse](#)

[Translate](#)

[Options](#)

[News](#)

[Login](#)

[Help](#)

[Home](#) > [IP Services](#) > [PATENTSCOPE Home](#) > [IP Services](#) > [PATENTSCOPE](#)

[\[Help\]](#)

[Portuguese](#)  [German](#)  [English](#)  [Spanish](#)  [French](#)  [Italian](#)  [Japanese](#)  [Korean](#)  [Dutch](#)  [Russian](#)   
[Swedish](#)  [Chinese](#)  [IPC](#)

IPC Filter

Domains [MAR]

B63

Field(s) you want to search:

Abstract

Acceptable distance between matched words:

Sentence

Stemming



[Submit Query](#)

[Back](#)

[Start Over](#)



Results 1-10 of 2,209 for Criteria: (DE\_AB:((( Schiffes OR Ship ) AND ( Festmachen OR Mooring OR Vertäuen OR Verankern OR Belegen OR Festhalten ))) OR EN\_AB:((( ship OR vessel ) AND ( clamping OR mooring ))) OR ES\_AB:((( buque OR barco OR embarcación OR navíos ) AND amarre )) OR FR\_AB:((( bateau OR navire ) AND ( amarrage OR amarrer OR mouillage OR ancrage OR blocage OR ancrer ))) OR IT\_AB:((( nave OR imbarcazioni ) AND ( ormeggio OR bloccare OR punto ))) OR JA\_AB:((( "船舶" OR "仕切り" OR "の舵" OR "船舶間" ) AND ( "係留" OR "係船" ))) OR KO\_AB:((( 선박 OR 선박들을 ) AND 계류 )) OR NL\_AB:((( schip OR schepen ) AND ( afmeren OR vastleggen OR meeranker OR vastmeren OR "het meren" OR meren ))) OR PT\_AB:((( navio AND ( amarração OR ancoragem OR "comandar mecanicamente o aperto" ))) OR RU\_AB:((( судна OR судов ) AND ( швартовки OR швартовочное OR зажимное ))) OR SV\_AB:((( skepp OR fartyg ) AND ( foertoejningar OR förtöjning OR förtöja ))) OR ZH\_AB:((( "船舶" OR "舰船" OR "船艇" ) AND ( "系泊" OR "式夹" OR "装夹" ))) AND ICF:(B63) Office(s):all Language:EN Stemming: true



prev 1 2 3 4 5 6 7 8 9 10 next Page: 1 / 221 Go >

Refine Search

Search



Analysis

Sort by: Relevance View All List Length 10 Machine translation



No	Ctr	Title	PubDate	Int.Class	Appl.No	Applicant	Inventor
1.	ES	0457391 - PERFECCIONAMIENTOS EN DISPOSITIVOS DE AMARRE PARA EMBARCACIONES.	01.02.1978	B63B	P0457391	STRAINSTALL LIMITED	

Perfeccionamientos en dispositivos de amarre para embarcaciones, caracterizados porque se dota a cada dispositivo de medios por los cuales una fuerza debida a tensión en una amarra, se transmite a un elemento estacionario por medio de una pieza conectada al elemento estacionario mediante un pasador de seguridad.

Results 1-10 of 2,209 for Criteria: (DE\_AB:((( Schiffes OR Ship ) AND ( Festmachen OR Mooring OR Vertäuen OR Verankern OR Belegen OR Festhalten ))) OR EN\_AB:((( ship OR vessel ) AND ( clamping OR mooring ))) OR ES\_AB:((( buque OR barco OR embarcación OR navíos ) AND amarre )) OR FR\_AB:((( bateau OR navire ) AND ( amarrage OR amarrer OR mouillage OR ancrage OR blocage OR ancrer ))) OR IT\_AB:((( nave OR imbarcazioni ) AND ( ormeggio OR bloccare OR punto ))) OR JA\_AB:((( "船舶" OR "仕切り" OR "の舵" OR "船舶間" ) AND ( "係留" OR "係船" ))) OR KO\_AB:((( 선박 OR 선박들을 ) AND 계류 )) OR NL\_AB:((( schip OR schepen ) AND ( afmeren OR vastleggen OR meeranker OR vastmeren OR "het meren" OR meren ))) OR PT\_AB:((( navio AND ( amarração OR ancoragem OR "comandar mecanicamente o aperto" ))) OR RU\_AB:((( судна OR судов ) AND ( швартовки OR швартовочное OR зажимное ))) OR SV\_AB:((( skepp OR fartyg ) AND ( foertoejningar OR förtöjning OR förtöja ))) OR ZH\_AB:((( "船舶" OR "舰船" OR "船艇" ) AND ( "系泊" OR "式夹" OR "装夹" ))) AND ICF:(B63) Office(s):all Language:EN Stemming: true

prev 1 2 3 4 5 6 7 8 9 10 next Page: 1 / 221 Go >

Refine Search

Search  

### Analysis

Options  Table  Graph Options  bar  pie

Countries		Main IPC		Main Applicant		Main Inventor		Pub Date	
Name	No	Name	No	Name	No	Name	No	Date	No
United States	657	B63B	2007	SINGLE BUOY MOORINGS INC.	53	Poldervaart Leendert	27	2004	93
PCT	488	E02B	172	SAMSUNG HEAVY IND. CO., LTD.	36	Boatman L. Terry	22	2005	105
European Patent Office	242	B63H	158			Pollack Jack	15	2006	75
Japan	203	B63C	122	Single Buoy Moorings Inc.	33	De Baan Jacob	11	2007	87
Canada	153	E21B	90	BLUEWATER ENERGY SERVICES B.V.	28	松本 勉	10	2008	106
China	150	F16L	52	SINGLE BUOY MOORINGS	25	POLLACK JACK	10	2009	120
Republic of Korea	125	F16G	35			POLDERVAART, LEENDERT	9	2010	120
Spain	75	B65G	32	FMC CORPORATION	22	BREIVIK, Kåre	9	2011	127
Russian Federation	36	B67D	31	Amtel, Inc.	18	BOATMAN, L., Terry	9	2012	140
Mexico	28	B63J	29	MITSUBISHI HEAVY IND LTD	17	BREIVIK, KARE	8	2013	90
Brazil	26			BLUEWATER ENERGY SERVICES BV	16			2014	15

# TAPTA



## PATENTSCOPE

Translation Assistant for Patent Titles and Abstracts

[English](#) | [Français](#) | [中文](#)

[Home](#) > [IP Services](#) > [PATENTSCOPE](#) > [Database Search](#) > [Translation Assistant](#)

### Translate

[\[help/user guide\]](#)

This tool is based on statistics and trained only on patent titles and abstracts.  
You can cut and paste titles/abstracts from any patent application.

Source text:

Polymers which can be used in p-type materials for organic electronic devices and photovoltaic cells. Compounds, monomers, dimers, trimers, and polymers comprising formula (I) and/or formula (VIII) are prepared

Language pair:

Domain:

- English->French
- French->English
- English->German
- German->English
- Japanese->English (Beta)
- English->Japanese (Beta)
- English->Chinese
- Chinese->English

Translate



## Translate

[\[help/user guide\]](#)

This tool is based on statistics and trained only on patent titles and abstracts.  
You can cut and paste titles/abstracts from any patent application.

Source text: Polymers which can be used in p-type materials for organic electronic devices and photovoltaic cells. Compounds, monomers, dimers, trimers, and polymers comprising formula (I) and/or formula (VIII) are prepared

Language pair: ...

Domain: [automatic detection] [automatic detection] ADMN-Admin, Business, Management & Soc Sci AERO-Aeronautics & Aerospace Engineering AGRI-Agriculture, Fisheries & Forestry AUDV-Audio, Audiovisual, Image & Video Tech AUTO-Automotive & Road Vehicle Engineering BLDG-Civil Engineering & Building Construction CHEM-Chemical & Materials Technology DATA-Computer Sci, Telecom & Broadcasting ELEC-Electrical Engineering & Electronics ENGY-Energy, Fuels & Heat Transfer Eng ENVR-Environmental & Safety Engineering FOOD-Foods & Food Technology GENR-Generalities, Language, Media & Info Sci HOME-Home Contents & Household Maintenance HORO-Precision Mechanics, Jewelry & Horology MANU-Manufacturing & Materials Handling Tech MARI-Marine Engineering MEAS-Standards, Units, Metrology & Testing MECH-Mechanical Engineering

Translate



This tool is based on statistics and trained only on patent titles and abstracts.  
You can cut and paste titles/abstracts from any patent application.

Source text:

/ 一种页岩气作业方法、包括如下步骤：a、钻井；b、压裂；c、导出页岩气；d 将能够供给页岩气的井所输出的全部页岩气，或至少部分页岩气供给燃气发电机进行发电，并将所发出的电能输出至页岩气作业所使用的设备，或至少部分页岩气作业所使用的设备中改变了现有技术中、开采全程均用柴油发电机，或外界工业用电的方式进行供电的方式，实现“以气打气，气电结合”的方式、降低施工成本。 /

Language pair:

Chinese-&gt;English

Domain:

MECH-Mechanical Engineering

Translate

**This automatic translation is provided for information only, it may contain discrepancies or mistakes and does not have any juridical value.**

- Please hover your mouse over parallel segments of text
- Click to view other proposals
- Select words or phrases on the left to access other translation proposals

一种页岩气作业方法、包括如下步骤：a、钻井；b、压裂；c、导出页岩气；d 将能够供给页岩气的井所输出的全部页岩气，或至少部分页岩气供给燃气发电机进行发电，并将所发出的电能输出至页岩气作业所使用的设备，或至少部分页岩气作业所使用的设备中改变了现有技术中、开采全程均用柴油发电机，或外界工业用电的方式进行供电的方式，实现“以气打气、气电结合”的方式、降低施工成本。 /

the shale gas operation method, comprising the following steps: a, well drilling; b, fracturing; c, shale gas; d can supply shale gas well the output of all the shale gas, or at least partial shale gas supply gas generator to generate electricity, and transmitting the generated power is output to the shale gas working devices, or at least partial shale gas working equipment used in the prior art, the whole extraction by diesel generator, or the external industrial electric mode power supply, "in a gas pump, a gas-electric combined" mode, and reducing the construction cost. . /

Edit translation



Survey in 2013

# Who are using PATENTSCOPE ?

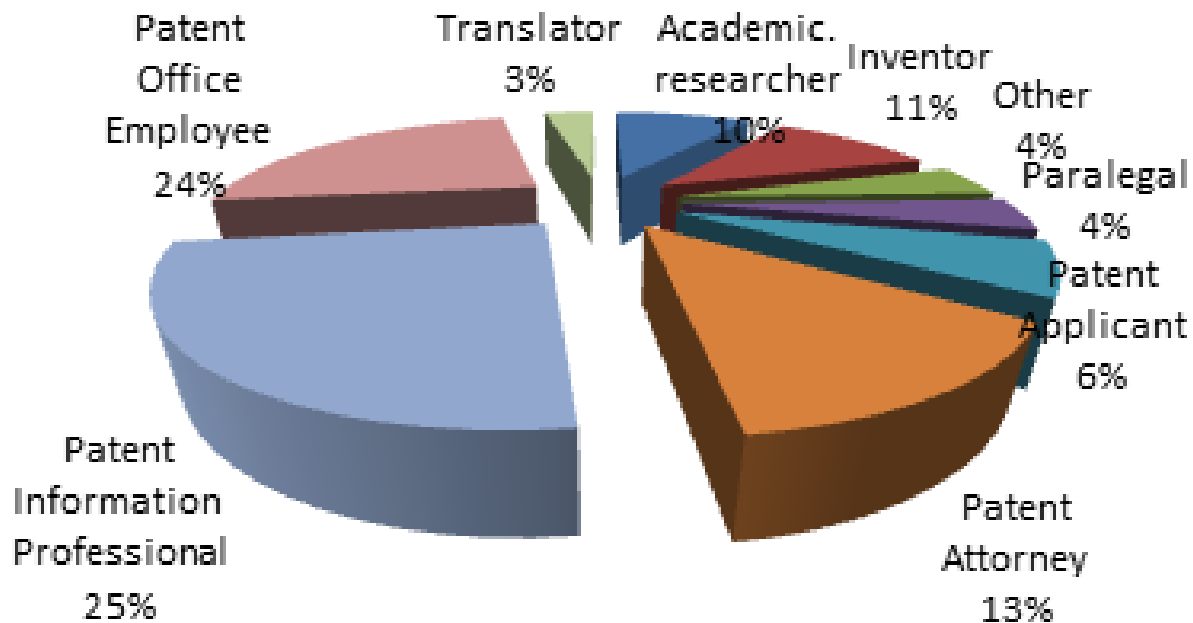

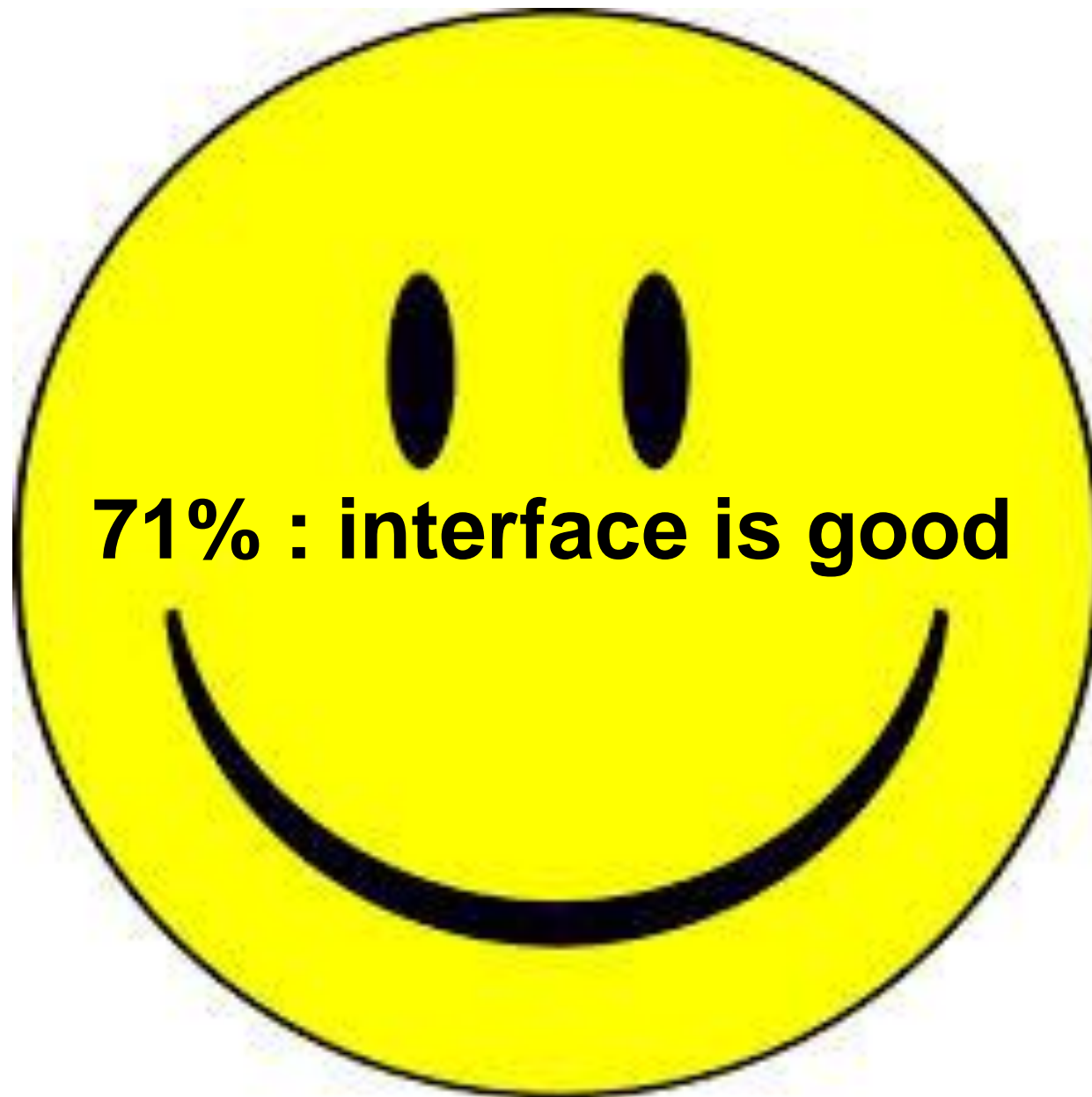

# Monthly webinar

[Media](#)[Meetings](#)[Contact Us](#)[My Account](#)[English](#) ▾[IP Services](#)[Policy](#)[Cooperation](#)[Reference](#)[About IP](#)[Inside WIPO](#)[Home](#)[Reference](#)[PATENTSCOPE](#)[Webinars](#)

## PATENTSCOPE Webinars

Webinars are used by WIPO to deliver information, training and updates on the [PATENTSCOPE search system](#) to a remote audience using the Internet.

Please [contact us](#) if your firm, company or organization is interested in attending a webinar on a particular topic.

### Quick links

- [Frequently asked questions](#)

# GLOBAL DATABASES, TOOLS, AND PLATFORMS FOR IP BUSINESS (FREE)

- PATENTSCOPE
- Global Brand Database
- WIPO Lex
- WIPO IPAS, WIPO DAS
- WIPO CASE
- WIPO RE:SEARCH
- WIPO GREEN

# GLOBAL BRANDS DATABASE

- Over 12 million records relating to internationally-protected trademarks, etc.
  
- Free of charge simultaneous brand-related searches across multiple collections, including:
  - Trademarks registered under Madrid System
  
  - Appellations of Origin registered under Lisbon System
  
  - Emblems protected under the Paris Convention 6ter
  
  - Algeria, Australia, Canada, Egypt, Estonia, Israel, Morocco, Singapore, Switzerland, UAE, US

WIPO is the global forum for intellectual property services, policy, information and cooperation.

## We deliver global services for protecting IP

File, manage or search patents, trademarks, designs and appellations of origin. Not there yet? Learn all about intellectual property and how to protect it.

### WIPO | PCT

The International Patent System

### WIPO | MADRID

The International Trademark System

### WIPO | HAGUE

The International Design System

## Alternative dispute resolution

Settle IP and technology disputes out of court using the fast, flexible and cost-effective services offered by the WIPO Arbitration and Mediation Center.

## Domain name disputes

Resolve cybersquatting and other disputes relating to trademark domain names.

## We shape international IP rules for a changing world

Follow policy discussions and negotiations on the future development of IP in our standing committees and meetings.

### Next meetings

Standing Committee on the Law of Patents

Jan 27–31

Intergovernmental Committee on IP and Genetic Resources, Traditional Knowledge and Folklore

Feb 3–7

[All upcoming meetings](#)

FEATURED

### WIPO Assemblies

The **52nd Series of Meetings of the Assemblies** of the Member States of WIPO took place in Geneva from December 10 to 12, 2013.

- [Documents](#) | [Videos on demand](#)

## We provide access to the world's IP information

Search technology and brand-related information in our free global databases. Download our other reference materials: publications, statistics, economic studies and more.

### PATENTSCOPE

35 million international and national patent documents

### Global Brand Database

11 million international and national records of trademarks, appellations of origin and emblems

### ROMARIN

International marks recorded under the Madrid System

### WIPO Lex

IP laws and treaties

FEATURED

### World IP Indicators

Latest statistical report shows IP filing activity is extending its run of pre-crisis level growth.

[Download the full Report](#)





# Global Brand Database

Search brand information from multiple national and international sources, including trademarks, appellations of origin and official emblems.

**SEARCH BY** Brand Names Numbers Dates Class Country

Text =   Stemming

Logo =  lookup

Goods (All) ▾ =

search 🔍

**FILTER BY** Source Status Image Origin App. Date \* Expiration \*

Display:  Sort:

AE Marks (AETM)	<b>39,540</b>	AU Marks (AUTM)	<b>1,368,167</b>
CA Marks (CATM)	<b>1,346,159</b>	CH Marks (CHTM)	<b>335,495</b>
DZ Marks (DZTM)	<b>18,080</b>	EE Marks (EETM)	<b>53,571</b>
EG Marks (EGTM)	<b>64,533</b>	IL Marks (ILTM)	<b>230,408</b>
MA Marks (MATM)	<b>135,386</b>	PH Marks (PHTM)	<b>310,062</b>
SC Marks (SCTM)	<b>576,929</b>	US Marks (USTM)	<b>7,484,006</b>

filter +

1 - 10 / 12,737,801

TMview [↗](#)

Display:  per page

1 / 1,273,781

	Brand	Source	Status	Score	Origin	Holder	Number	Reg. Date	Image Class	Nice Class	Image
<input type="checkbox"/>	HEALTH QPONS	US TM	Pending	1	US	Health Qpons LLC	86139574	2014-05-27		42	
<input type="checkbox"/>	CEO UPDATE	US TM	Pending	1	US	Leading Authorities, Inc.	86122534	2014-05-27		16, 41	
<input type="checkbox"/>	ACQUIRE	US TM	Pending	1	US	Price Network Inc.	86110134	2014-05-27		35	
<input type="checkbox"/>	HITTER'S LOG	US TM	Pending	1	US	Iconic Sports Technology, Inc.	85691803	2014-05-27		9, 42	
<input type="checkbox"/>	ALASKAN GEM	US TM	Pending	1	US	Alaskan Gem Store	86137873	2014-05-27		14	
<input type="checkbox"/>	THE LOOK-UP LINE	US TM	Pending	1	US	The Thomas E. Smith Foundation	86138285	2014-05-27		35	
<input type="checkbox"/>	FINISH COAT	US TM	Pending	1	US	Weber Advertising	86137416	2014-05-20		19	
<input type="checkbox"/>	ACK SURF	US TM	Pending	1	US	Ack Surf, LLC	85932738	2014-05-20		25	
<input type="checkbox"/>	SAAS+ ENTERPRISE ARCHITECTURE	US TM	Pending	1	US	Deverus, Inc.	86115137	2014-05-13		9	
<input type="checkbox"/>	CLEANBLU	US TM	Pending	1	US	Gina Lenger	86157169	2014-05-13		11	

1 - 10 / 12,737,801

Display:  per page

1 / 1,273,781

# Global Brand Database

Search brand information from multiple national and international sources, including trademarks, appellations of origin and official emblems.

SEARCH BY Brand Names Numbers Dates Class Country

Text =   Stemming

Logo =  lookup

Goods (All) ▾ =

search 🔍

CURRENT SEARCH

BRAND:mastercard ✕

FILTER BY Source Status Image Origin App. Date\* Expiration\*

Display: List ▾ Sort: Value - asc ▾

AE Marks (AETM)	5	AU Marks (AUTM)	94
CA Marks (CATM)	119	CH Marks (CHTM)	48
DZ Marks (DZTM)	4	EE Marks (EETM)	11
EG Marks (EGTM)	17	IL Marks (ILTM)	56
MA Marks (MATM)	42	PH Marks (PHTM)	38
SC Marks (SCTM)	78	US Marks (USTM)	202

filter +

1 - 30 / 898

TMview 🔗



Display: 30 ▾ per page

options ⚙

1 / 30

Sort by

Score - desc ▾

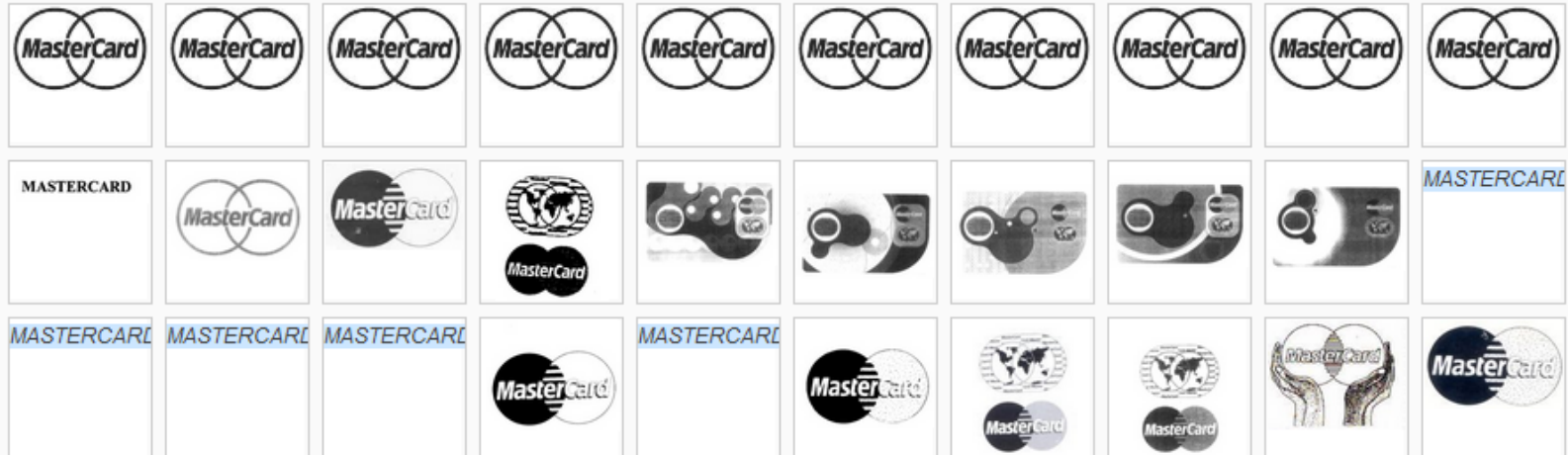

# Global Brand Database

Search brand information from multiple national and international sources, including trademarks, appellations of origin and official emblems.

← back

◀ 10 / 898 ▶

Israeli Trademark



178973 MASTERCARD

Status: active

**(151) Date of the registration**

2006-06-07

**(210) Serial number of the application**

178973

**(220) Date of filing of the application**

2005-03-07

**(180) Expected expiration date of the registration/renewal**

2015-03-07

**(540) Mark**



**(531) International Classification of the Figurative Elements of Marks (Vienna Classification)**

❶ 26.01.

**(550) Indication relating to the nature or kind of mark**

Trademark/Service mark

**(500) Various information**

If the Hebrew version of the list of services or part thereof is unclear, ambiguous or incorrect, it should be interpreted according to the English version.

**(731) Name and address of the applicant**

MasterCard International Incorporated  
Purchase, New York, U.S.A.

# Global Brand Database

Search brand information from multiple national and international sources, including trademarks, appellations of origin and official emblems.

↩ back

◀ 10 / 898 ▶

Israeli Trademark



178973 MASTERCARD

Status: active

**(151) Date of the registration**

2006-06-07

**(210) Serial number of the application**

178973

**(220) Date of filing of the application**

2005-03-07

**(180) Expected expiration date of the registration/renewal**

2015-03-07

**(540) Mark**



**(531) International Classification of the Figurative Elements of Marks (Vienna Classification)**

**26.01.**

**(550) Indication of the nature or kind of mark**

Trademark/Service mark

**(500) Various information**

If the Hebrew version of the list of services or part thereof is unclear, ambiguous or incorrect, it should be interpreted according to the English version.

**(731) Name and address of the applicant**

MasterCard International Incorporated

# Global Brand Database

Search brand information from multiple national and international sources, including trademarks, appellations of origin and official emblems.

**SEARCH BY** Brand Names Numbers Dates Class Country

Text =   Stemming

Logo =  lookup

Goods (All) ▾ =

↗

?

CURRENT SEARCH

LOGO:26.01\* ✕

**FILTER BY** Source Status Image Origin App. Date \* Expiration \*

Display:  ▾ Sort:  ▾

AE Marks (AETM)	0	AU Marks (AUTM)	0
CA Marks (CATM)	81,241	CH Marks (CHTM)	0
DZ Marks (DZTM)	1,619	EE Marks (EETM)	0
EG Marks (EGTM)	2,838	IL Marks (ILTM)	13,372
MA Marks (MATM)	0	PH Marks (PHTM)	17,345
SC Marks (SCTM)	0	US Marks (USTM)	288,284

1 - 30 / 456,229

↗

Display:  ▾ per page  ✕

/ 15,208

Sort by

▾



# Global Brand Database

Search brand information from multiple national and international sources, including trademarks, appellations of origin and official emblems.

## SEARCH BY

Brand Names Numbers Dates Class Country

Text =   Stemming

Logo =  [lookup](#)

Goods =

[?](#)

## FILTER BY

Source	Status	App. Date	Origin	Designation	Expiration
Display: List			Sort: Count - desc		
CA	61,323	CH	8,534	DE	7,809
FR	7,784	PH	7,646	BX	7,592
NL	7,592	BE	7,592	LU	7,592
IT	7,452	AT	7,056	ES	6,736
RU	5,800	PT	5,465	HU	5,158
CN	4,590	CZ	4,315	RS	4,314
RO	4,122	PL	4,016	LI	3,846
SK	3,651	HR	3,632	UA	3,595
MC	3,490	SI	3,408	EG	3,378
MA	3,288				

[?](#)

## Current Search

LOGO:(04.03.19 24.09.02 24.09.21 24.09.22 05.03.06 26.01.01 26.01.04 26.01.15) [x](#)

## Current Filter

201 - 250 / 88,077

TMview



Display: 50

per page [options](#)

5 / 1,762

Sort by Score - desc



# Global Brand Database

Search brand information from multiple national and international sources, including trademarks, appellations of origin and official emblems.

**SEARCH BY** Brand Names Numbers Dates Class Country

Text =   Stemming

Logo =  lookup

Goods (All) ▾ =

search ↗

**FILTER BY** Source Status Image Origin App. Date \* Expiration \*

1 Pick an image



delete 🗑

2 Pick a strategy

- Shape
- Color
- Texture
- Composite

3 Pick an image type

Verbal	309,395
Nonverbal	386,930
Combined	1,553,027
Unknown	81,614

filter +

**CURRENT FILTER**

IMAGE:Shape ✕

1 - 30 / 3,850,308

TMview ↗



Display: 30

per page

options ⚙



1

/ 128,344



Sort by

Score - desc ▾

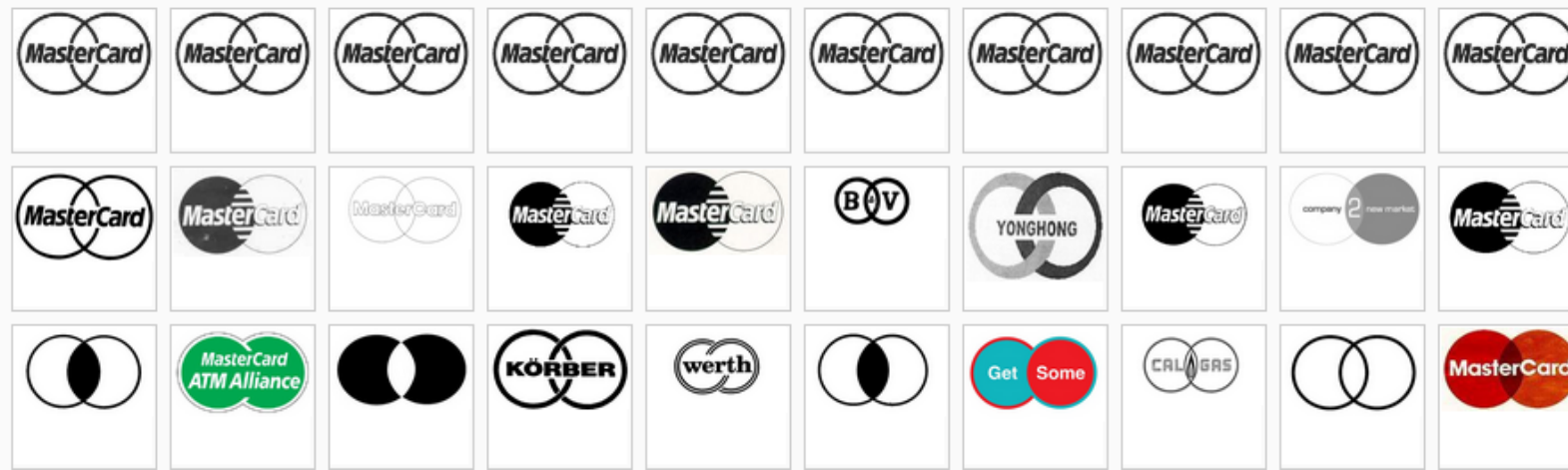

# Global Brand Database

Search brand information from multiple national and international sources, including trademarks, appellations of origin and official emblems.

**SEARCH BY** Brand Names Numbers Dates Class Country

Text =   Stemming

Logo =  lookup

Goods (All) ▾ =

search 🔍

CURRENT SEARCH

BRAND:mastercard ✕

🗑️



**FILTER BY** Source Status Image Origin App. Date\* Expiration\*

Display: List ▾ Sort: Value - asc ▾

AE Marks (AETM)	5	AU Marks (AUTM)	94
CA Marks (CATM)	119	CH Marks (CHTM)	48
DZ Marks (DZTM)	4	EE Marks (EETM)	11
EG Marks (EGTM)	17	IL Marks (ILTM)	56
MA Marks (MATM)	42	PH Marks (PHTM)	38
SC Marks (SCTM)	78	US Marks (USTM)	202

filter +

1 - 30 / 898

TMview 🔗

Display: 30 ▾ per page options ⚙️

1 / 30

Sort by

Score - desc ▾

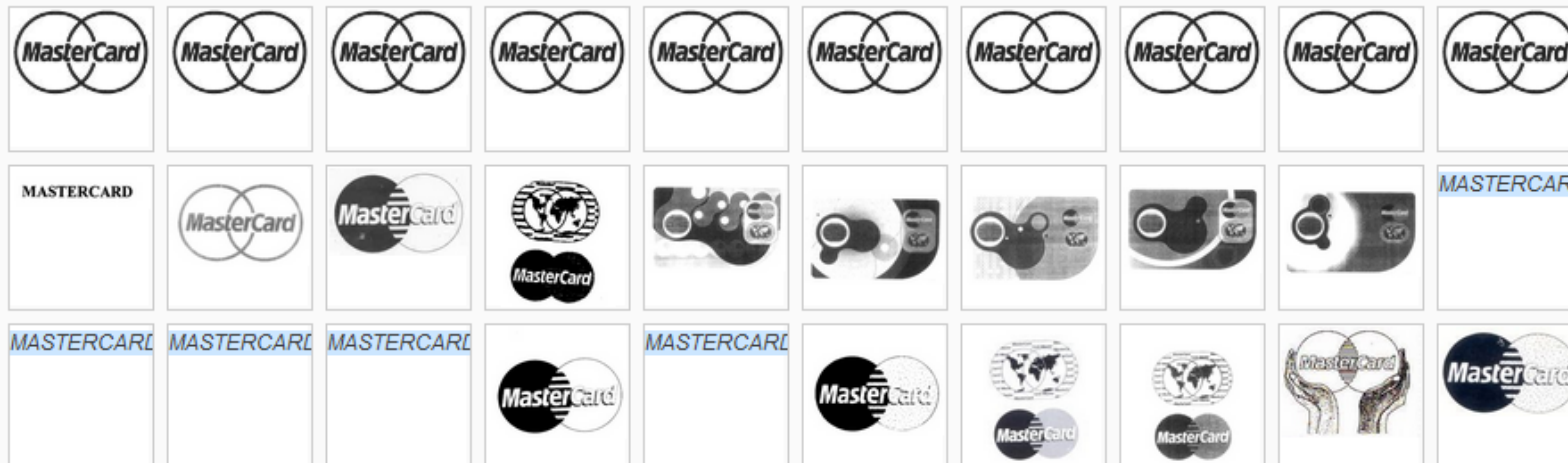



## Find term

Search

Clear



Advanced search



Open

35 of 35 offices finished

## List of results

WIPO Global Brand DB | Expand WIPO designated countries | Page 1 of 132 | 10 20 30 50 75 100 | Displaying results 1 - 10 of 1,311

Image	Graphic repre...	Trade mark name	Trade ...	Trade mark ...	Trade mark ...	Nice class	Applicant name	Application ...	Trade mark type
<input type="checkbox"/>	Image Not Available	"HELLENIC BANK EXPLORER LINK MASTERCARD	CY	67674	Ended	9	ΕΛΛΗΝΙΚΗ ΤΡΑΠΕΖΑ ΛΙΜΙΤΕΔ	16-07-2003	Combined
<input type="checkbox"/>	Image Not Available	"MASTERCARD	CY	35214	Registered	16	MasterCard International Inco...	08-10-1991	Combined
		(MARCHIO FIGURATIVO) IL MARCHIO (FIGURATIVO A COLORI) E' COSTITUITO DALLA DENOMINAZIONE GROSSETOCARD, IN CARATTERE STAMPATELLO MAIUSCOLO DI COLORE ROSSO, POSTA NELLA PARTE SUPERIORE SINISTRA DI UNA FIGURA RETTANGOLARE CON ANGOLI SMUSSATI. A SINISTRA DELLA SCRITTA GROSSETOCARD E' COLLOCATO LO STEMMA DEL COMUNE DI GROSSETO, MENTRE, A DESTRA DELLA SCRITTA, CENTRATO ORIZZONTALMENTE ED ESTESO IN VERTICALE SU TUTTA LA TESSERA, VI E' IL LOGO DELL'U.S. GROSSETO F.C.. TALE LOGO E' COSTITUITO DA UNO SCUDETTO DI COLORE ROSSO							

# GLOBAL DATABASES, TOOLS, AND PLATFORM FOR IP BUSINESS (FREE)

- PATENTSCOPE
- Global Brand Database
- **WIPO Lex**
- WIPO IPAS, WIPO DAS
- WIPO CASE
- WIPO RE:SEARCH
- WIPO GREEN

WIPO is the global forum for intellectual property services, policy, information and cooperation.

## We deliver global services for protecting IP

File, manage or search patents, trademarks, designs and appellations of origin. Not there yet? Learn all about intellectual property and how to protect it.

### WIPO | PCT

The International Patent System

### WIPO | MADRID

The International Trademark System

### WIPO | HAGUE

The International Design System

## Alternative dispute resolution

Settle IP and technology disputes out of court using the fast, flexible and cost-effective services offered by the WIPO Arbitration and Mediation Center.

## Domain name disputes

Resolve cybersquatting and other disputes relating to trademark domain names.

## We shape international IP rules for a changing world

Follow policy discussions and negotiations on the future development of IP in our standing committees and meetings.

### Next meetings

Standing Committee on the Law of Patents

Jan 27–31

Intergovernmental Committee on IP and Genetic Resources, Traditional Knowledge and Folklore

Feb 3–7

[All upcoming meetings](#)

FEATURED

### WIPO Assemblies

The **52nd Series of Meetings of the Assemblies** of the Member States of WIPO took place in Geneva from December 10 to 12, 2013.

- [Documents](#) | [Videos on demand](#)

## We provide access to the world's IP information

Search technology and brand-related information in our free global databases. Download our other reference materials: publications, statistics, economic studies and more.

### PATENTSCOPE

35 million international and national patent documents

### Global Brand Database

11 million international and national records of trademarks, appellations of origin and emblems

### ROMARIN

International marks recorded under the Madrid System

### WIPO Lex

IP laws and treaties

FEATURED

### World IP Indicators

Latest statistical report shows IP filing activity is extending its run of pre-crisis level growth.

[Download the full Report](#)





## WIPO Lex

WIPO Lex is a one-stop **search facility** for national laws and treaties on intellectual property (IP) of WIPO, WTO and UN Members. It also features related information which elaborates, analyzes and interprets these laws and treaties. It provides streamlined access to reference material of key importance for optimal information on the global IP System.

- [About WIPO Lex](#)
- [Contact us](#)

[Members' Profiles](#)  
[Treaty Secretariat](#)  
[WIPO-WTO Common Portal](#)  
[Glossary](#)

[IP Legislation](#)[Treaties](#)[Full Text Search](#)

WIPO/WTO/UN Members

Select a Member

- Afghanistan (14)
- Albania (34)
- Algeria (26)
- Andorra (16)
- Angola (22)

Subject Matter

Select a Topic

[Search WIPO Lex](#)[Reset](#)

WIPO/WTO/UN Members

Select a Member

Afghanistan (14)  
 Albania (34)  
 Algeria (26)  
 Andorra (16)  
 Angola (22)

Subject Matter

Select a Topic

Select a Topic  
 Alternative Dispute Resolution (ADR)  
 Competition  
 Copyright and Related Rights (Neighboring Rights)  
 Domain Names  
 Enforcement of IP and Related Laws  
 Genetic Resources  
 Geographical Indications  
 Industrial Designs  
 Industrial Property  
 IP Regulatory Body  
 Layout Designs of Integrated Circuits  
 Patents (Inventions)  
 Plant Variety Protection  
 Trade Names  
 Trademarks  
 Traditional Cultural Expressions  
 Traditional Knowledge (TK)  
 Transfer of Technology  
 Undisclosed Information (Trade Secrets)  
 Utility Models  
 Other

## News on IP Laws

December 10, 2013 [South Africa: The Intellectual Property Laws](#)  
 shall come into force on a date to be fixed by the Minister of Trade and Industry. The new laws will provide for the protection of indigenous knowledge and to create a system for the protection of indigenous knowledge in South Africa. To that end, it amends the existing intellectual property laws, namely, the [Performers' Rights Act 1993](#) and the [Designs Act 1993](#).

October 18, 2013 [Philippines: The BOT Office Order No. 13-06, Series of 2013, on the Implementation Guidelines for Office Order No. 13-061, Series 2013, on Trademark Applications with Priority Right Claim](#), issued by the Bureau of Trademarks (BOT) on October 18, 2013, provides for the guidelines to ensure the accurate implementation of the Office Order No. 13-061, which became effective on May 2, 2013. These guidelines primarily refer to the pending trademark applications at the time the Order became effective, the requirement of a copy of the foreign application as a basis for claiming convention priority, the application of goods and services in the Philippines compulsorily covered by the applications used as basis for claiming convention priority, the national applications where fees are not paid in full, the notice of registration of foreign application to the IP office of the Philippines (the IPOPHL) and the conditions for exemption from conformity to the list of goods and services in the foreign registration for the trademark applications for goods and services in the Philippines.

# WIPO Lex

WIPO Lex is a one-stop **search facility** for national laws and treaties on intellectual property (IP) of WIPO, WTO and UN Members. It also features related information which elaborates, analyzes and interprets these laws and treaties. It provides streamlined access to reference material of key importance for optimal information on the global IP System.

- [Members' Profiles](#)
- [Treaty Secretariat](#)
- [WIPO-WTO Common Portal](#)
- [Glossary](#)

- [About WIPO Lex](#)
- [Contact us](#)

WIPO/WTO/UN Members

- United Arab Emirates (16)
- United Kingdom (160)
- United Republic of Tanzania (25)
- United States of America (47)**
- Uruguay (53)
- Uzbekistan (93)

Subject Matter

Select a Topic

## News on IP Laws

United States of America: IP Laws and Treaties - Mozilla Firefox

File Edit View History Bookmarks Tools Help

United States of America: IP Laws and Treat... +

www.wipo.int/wipolex/en/profile.jsp?code=US

IP Services Policy Cooperation Reference About IP Inside WIPO Search WIPO

Home Reference WIPO Lex

## United States of America (48 texts)

**Quick Access:** [Laws \(36 texts\)](#) | [Implementing Rules/Regulations \(12 texts\)](#) | [IP Legal Literature \(12 texts\)](#) | [Treaty Membership \(122 texts\)](#) | [Relevant links](#)



Outline of the Legal and Regulatory Framework for Intellectual Property in the United States of America

---

### Laws

#### Constitution / Basic Law (Date of current version)

- [The Constitution of the United States of America \(1787\)](#)

#### Main IP Laws: enacted by the Legislature (Date of current version)

- [An Act to Correct and Improve Certain Provisions of the Leahy-Smith America Invents Act and Title 35, United States Code \(Public Law No. 112-274\) \(2013\)](#)
- [U.S. Patent Law, 35 U.S.C. §§ 1 et seq. \(2013\)](#)
- [U. S. Trademark Law, 15 U.S.C. §§ 1051 et seq. \(as amended in 2013\) \(2013\)](#)
- [An Act to Implement the Provisions of the Hague Agreement and the Patent Law Treaty \(2012\)](#)
- [Act to Amend the Trademark Act of 1946 to Correct an Error in the Provisions Relating to Remedies for Dilution \(Public Law 112-190, 126 Stat. 1436\) \(2012\)](#)
- [U.S. Trademark Law, Rules of Practice, 37 C.F.R. 2 et seq. & Federal Statutes, 15 U.S.C. § 1051 et seq. and 35. U.S.C. 1 \(2012\)](#)
- [Leahy-Smith America Invents Act \(AIA\) \(2011\)](#)

# United States of America

## Leahy-Smith America Invents Act (AIA)

### Shortcuts

[United States of America](#)

<b>Year of current version:</b>	2011
<b>Date of Text (Enacted):</b>	September 16, 2011
<b>Type of Text:</b>	Main IP Laws: enacted by the Legislature
<b>Subject Matter:</b>	Enforcement of IP and Related Laws, IP Regulatory Body, Patents (Inventions)
<b>Notes:</b>	<p>The Leahy-Smith 'America Invents Act' (AIA), which was formerly titled the 'Patent Reform Act of 2011', amends title 35, United States Code to provide for patent reform.</p> <p>Date of entry into force: The various provisions contained in the Act's 37 sections take effect on different dates.</p>

### Available Texts:

**English** [Leahy-Smith America Invents Act \(AIA\)](#) [PDF](#)

### Related Legislation:

#### Amends

- [U.S. Patent Law, 35 U.S.C. §§ 1 et seq. \(US240\)](#)

#### Relates to

- [America Invents Act: Effective Dates \(30 Sept 2011\) \(US220\)](#)

#### Is amended by

- [An Act to Correct and Improve Certain Provisions of the Leahy-Smith America Invents Act and Title 35, United States Code \(Public Law No. 112-274\) \(US239\)](#)





## Portugal (142 texts)

**Quick Access:** [Laws \(68 texts\)](#) | [Implementing Rules/Regulations \(26 texts\)](#) |  
[Geographical Indications \(48 texts\)](#) | [Treaty Membership \(81 texts\)](#) | [Relevant links](#)



[Background information on the Legal and Regulatory Framework for Intellectual Property in Portugal](#)

### Laws

#### Constitution / Basic Law (Date of current version)

- [Constitution of the Portuguese Republic \(2005\)](#)

#### Main IP Laws: enacted by the Legislature (Date of current version)

- [Law No. 109/2009 of September 15, 2009 \(Cybercrime Law\) \(2009\)](#)
- [Law No. 16/2008 of April 1, 2008 \(Enforcement of IP\) \(2008\)](#)
- [Industrial Property Code \(consolidated as of 2008\) \(2008\)](#)
- [Code of Copyright and Related Rights \(as last amended by Law No. 16/2008 of April 1, 2008\) \(2008\)](#)
- [Law No. 50/2004 of August 24, 2004 \(Copyright and Related Rights in the Information Society\) \(2004\)](#)
- [Law No. 83/2001 of 3 August \(Collecting Societies of Copyright and Related Rights\) \(2001\)](#)

# GLOBAL DATABASES, TOOLS AND PLATFORMS FOR IP BUSINESS (FREE)

- PATENTSCOPE
- Global Brand Database
- WIPO Lex
- [WIPO IPAS](#), [WIPO DAS](#)
- WIPO CASE
- WIPO RE:SEARCH
- WIPO GREEN

# IPAS AND DAS

- IPAS (IP Office Administration System) used by 60 IPOs
  - A WIPO software enabling small IPOs to electronically process patent, trademark, design applications
  
- DAS (Digital Access System) used by 11 IPOs
  - A System that allows IPOs and applicants to securely exchange or submit a digital copy of priority documents to multiple IPOs

# GLOBAL DATABASES, TOOLS, AND PLATFORM FOR IP BUSINESS (FREE)

- PATENTSCOPE
- Global Brand Database
- WIPO Lex
- WIPO IPAS, WIPO DAS
- WIPO CASE
- WIPO RE:SEARCH
- WIPO GREEN

# WIPO CASE

- “Centralized Access to Search and Examination Reports”
- Started with an initiative of IP Australia and the Vancouver Group (AU, CA, UK)
- Online patent work-sharing platform for patent examiners worldwide—secure sharing search and examination documentation
- IPOs can enhance quality and efficiency of patent examination
- CASE will be linked to Open Portal Dossier of IP5 to become the Global Portal Dossier
- How will it work?

# WIPO CASE (CONTINUED)

The System functions to:

- search by patent number and retrieve simple results or a list of patent family members.
- view bibliographic data, citation data (if available) and lists of documents available for each patent record.
- view and/or download the available documents.
- subscribe to notifications of updates to a given patent record.

Will be linked to OPD of IP5 -> “Global Dossier”

office.

---

## Participating Offices

There are two different levels of participation possible:

- **Accessing Office** - Examiners at the accessing office have access to the WIPO CASE web portal and can use the system to search for patent applications at other participating offices and to retrieve the documents that are made available by those offices;
- **Depositing Office** - The depositing office makes available the search and examination documentation for patent applications filed at that office. Technically, this may be done by uploading the documents into the WIPO CASE system hosted by WIPO, or by making the documents available to the WIPO CASE system via secure web services.

The following offices participate in the WIPO CASE system:

Country	Office	Accessing Office	Depositing Office	Notification
Australia	IP Australia	Yes	Yes	<a href="#">Notification by IP Australia (May 27, 2013)</a>
Canada	Canadian Intellectual Property Office	Yes	Yes	<a href="#">Notification by CIPO (June 25, 2013)</a>
China	State Intellectual Property Office of China	Yes	Yes	<a href="#">Notification by SIPO (November 2013)</a>
New Zealand	Intellectual Property Office of New Zealand	Yes	No	Currently operating under a bilateral agreement with WIPO.
Singapore	Intellectual Property Office of Singapore	Yes	No	Following the request of IPOS in July 2013 and the review by the WIPO CASE Consultative Group, Singapore is operating as an accessing office.
United Kingdom	The UK Patent Office	Yes	Yes	<a href="#">Notification by UK Patent Office (May 3, 2013)</a>

---

## Related links

# GLOBAL DOSSIER PLATFORM (WIPO-CASE, OPD AND PATENTSCOPE)

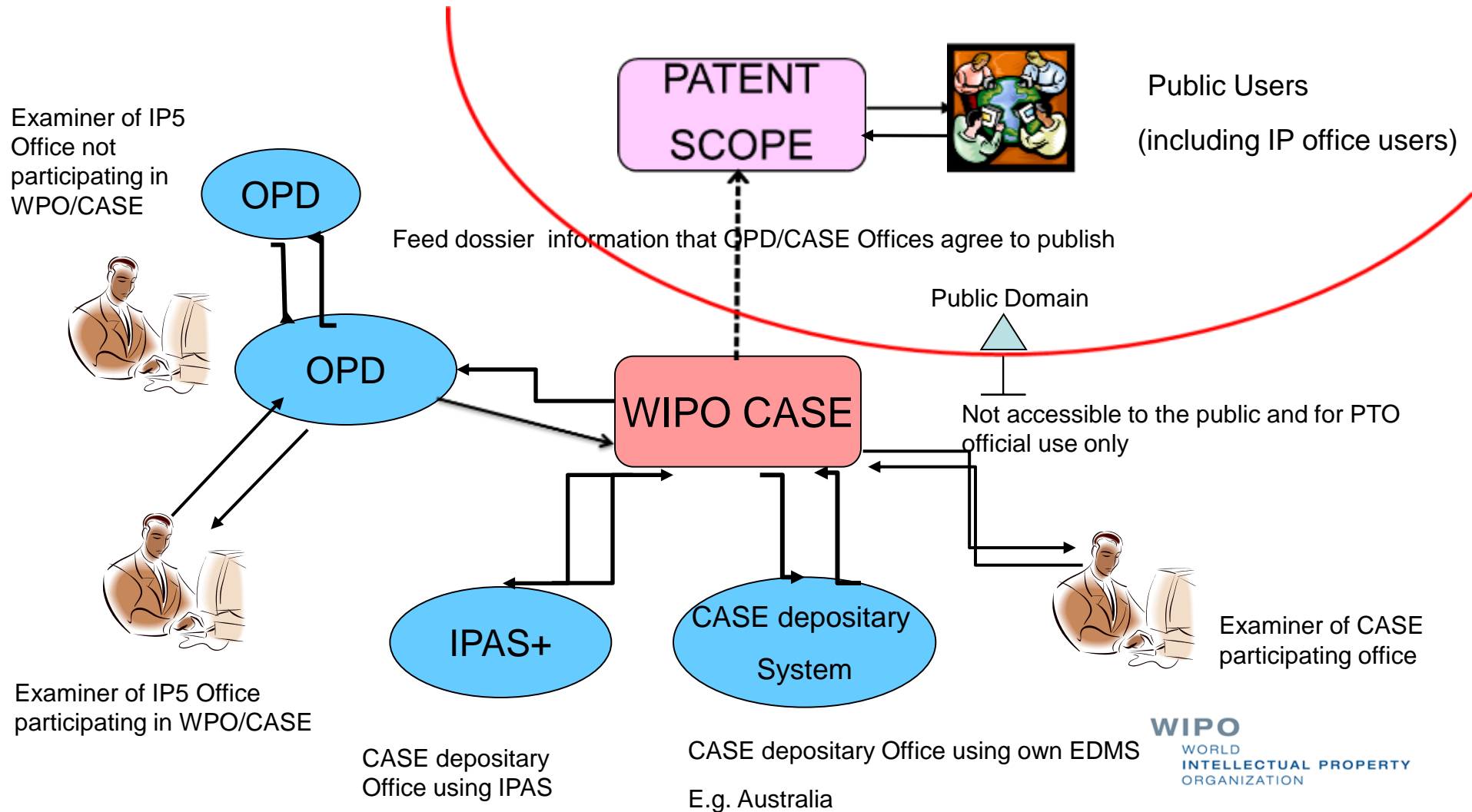



# GLOBAL DATABASES, TOOLS, AND PLATFORMS FOR IP BUSINESS (FREE)

- PATENTSCOPE
- Global Brand Database
- WIPO Lex
- WIPO IPAS, WIPO DAS
- WIPO CASE
- WIPO RE:SEARCH
- WIPO GREEN

Partnership platforms designed to facilitate collaboration and the sharing of technologies to address major challenges

Broad aims:

- Match-making for technology transfer and collaborations
- Reduce transaction costs
- Develop multi-stakeholder approaches
- Demonstrate practical means for the global policy issues

# WIPO RE: SEARCH

- A Global Database and Platform to bridge partners to use IP (including know-how and data) to facilitate R&D on neglected tropical diseases, tuberculosis, and malaria
- Royalty-free for R&D, manufacture and sale in LDCs
- Over 60 partners (pharmaceutical industry, research institutes such as NIH, Universities)
- As of January 2014, 44 collaborations

[www.wipo.int/research](http://www.wipo.int/research)

## WIPO Re:Search



PARTNERED WITH:



One of the world's great global health challenges is to overcome the impact of neglected tropical diseases, malaria and tuberculosis. These diseases negatively affect the lives of more than one billion people, many of whom live in the world's least developed countries. WIPO Re:Search aims to stimulate more research and development for new and better treatment options for those suffering from these conditions.

WIPO Re:Search provides access to intellectual property for pharmaceutical compounds, technologies, and – most importantly – know-how and data available for research and development for neglected tropical diseases, tuberculosis, and malaria. By providing a searchable, public database of available intellectual property assets and resources, WIPO Re:Search facilitates new partnerships to support organizations that conduct research on treatments for neglected tropical diseases, ultimately improving the lives of those most in need.

An important aspect of WIPO Re:Search is the opportunity it creates to transfer knowledge and build capacity at both the institutional and individual, human level. Recognizing the essential human aspect of development, IP Australia, the Australian Government agency that administers intellectual property (IP) rights, has generously made available financial resources under a Funds-in-Trust grant to WIPO to enable scientists from developing and Least Developed Countries to take 'sabbaticals' at the research facilities of developed country Members of WIPO Re:Search. Placements for these 'hosting arrangements' are arranged by BIO Ventures for Global Health, and to date have involved scientists from Cameroon, Egypt, Ghana, Nigeria, and South Africa. For further information refer to [collaboration agreements](#).

WIPO Re:Search is partnered with [BIO Ventures for Global Health](#).

■ WIPO Re:Search flyers [English [PDF](#) | Spanish [PDF](#) | French [PDF](#) | Portuguese [PDF](#)]



WIPO Re:Search - One year on  
[Video](#)

### LATEST NEWS

- [WIPO Re:Search Snapshot January 2014](#) (Jan 15, 2014)
- [WIPO Re:Search snapshot December 2013](#) (Dec 11, 2013)
- [WIPO Re:Search snapshot November 2013](#) (Nov 19, 2013)
- [WIPO Re:Search: a consortium catalyzing research and product development for neglected tropical diseases](#) (Oct 21, 2013)
- [WIPO Re:Search Snapshot October 2013](#) (Oct 20, 2013)
- [\[Archive\]](#)

**WIPO RE:SEARCH**

- About
- Database Search
  - About the Database
  - Frequently Asked Questions
  - Terms of Use
- Partnership Hub
- How to Participate
- Collaboration Agreements
- Supporting Services
- FAQs
- User Feedback

**TECHNICAL ADVISOR TO WIPO**

World Health Organization

## WIPO Re:Search Database

The WIPO Re:Search Database is composed of intellectual property assets, including compounds, enabling technologies, know-how, and other information that Providers have chosen to make available in WIPO Re:Search. All the information is publicly available and can be accessed without registration.

Please watch this space as Providers regularly upload additional entries and new Providers join WIPO Re:Search.

To inquire further about any particular items in the database, please note the Submission ID and [submit a request](#) or contact the [Partnership Hub](#).

Provider:

- 80 Degrees Pharmaceuticals (80P)
- Aberystwyth University
- African Institute of Biomedical Sciences and Technology (AIBST)
- Alnylam
- AstraZeneca (AZ)
- Caltech
- Center for World Health and Medicine (CWHM)
- Centre for Excellence for Malaria Diagnosis, University of Lagos
- Drugs for Neglected Diseases initiative (DNDi)
- Eisai
- Eskitis Institute
- GlaxoSmithKline (GSK)
- Infectious Disease Research Institute (IDRI)
- International Centre for Genetic Engineering and Biotechnology (ICGEB)
- International Vaccine Institute (IVI)
- iThemba
- Kenya Agricultural Research Centre (KARI)
- Kumasi Centre for Research in Tropical Medicine (KCRMT)
- Liverpool School of Tropical Medicine (LSTM)
- Massachusetts Institute of Technology (MIT)
- McGill University (McGill)
- Medical Research Council of South Africa (MRC)
- Medicines for Malaria Venture (MMV)
- Merck (MSD)
- NIH (USA)
- Northeastern University (NEU)
- Novartis
- PATH
- Pfizer
- Sanofi
- Seattle BioMed
- Stanford University
- Swiss Tropical and Public Health Institute
- Theodor Bilharz Research Institute - (TBRI)

# WIPO RE:SEARCH

Sharing Innovation in the Fight Against Neglected Tropical Diseases

Get involved:

- As a user
- As a provider
- As a supporter

(Adhere to Guiding principles, contact email: [re\\_search@wipo.int](mailto:re_search@wipo.int))

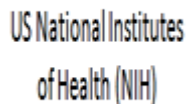

...

# WIPO GREEN

- A global database allowing users to make green technologies available for licensing or partnership, enter technology needs, search for technologies and needs
- Started a pilot with Japan Intellectual Property Association in 2011
- Launched in November 2013
- as of January 2014, over 800 offers
- Green tech providing companies in Germany, Japan, US etc.
- Partners include companies, universities, UN agencies, governments, IPOs, NGOs, etc.

# PARTNERS OF WIPO GREEN

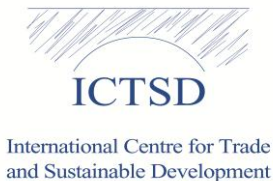





[www.wipo.int/green](http://www.wipo.int/green)



[About WIPO GREEN](#)

[WIPO GREEN Network](#)

[WIPO GREEN Database](#)

WIPO GREEN is an interactive marketplace that promotes innovation and diffusion of green technologies. Use our database and network to connect with technology and service providers, or advertise your needs.

## WIPO GREEN database

Search for green technology and intellectual property assets. If you are a provider search for needs.

[Needs](#)

[Technologies](#)

All technical fields



# SIX AREAS OF GREEN TECHNOLOGY MARKETS



Administrative,  
regulatory  
or design aspects



Agriculture /  
Forestry



Alternative energy  
production



Energy  
conservation



Transportation



Waste  
management

# THE CHALLENGE

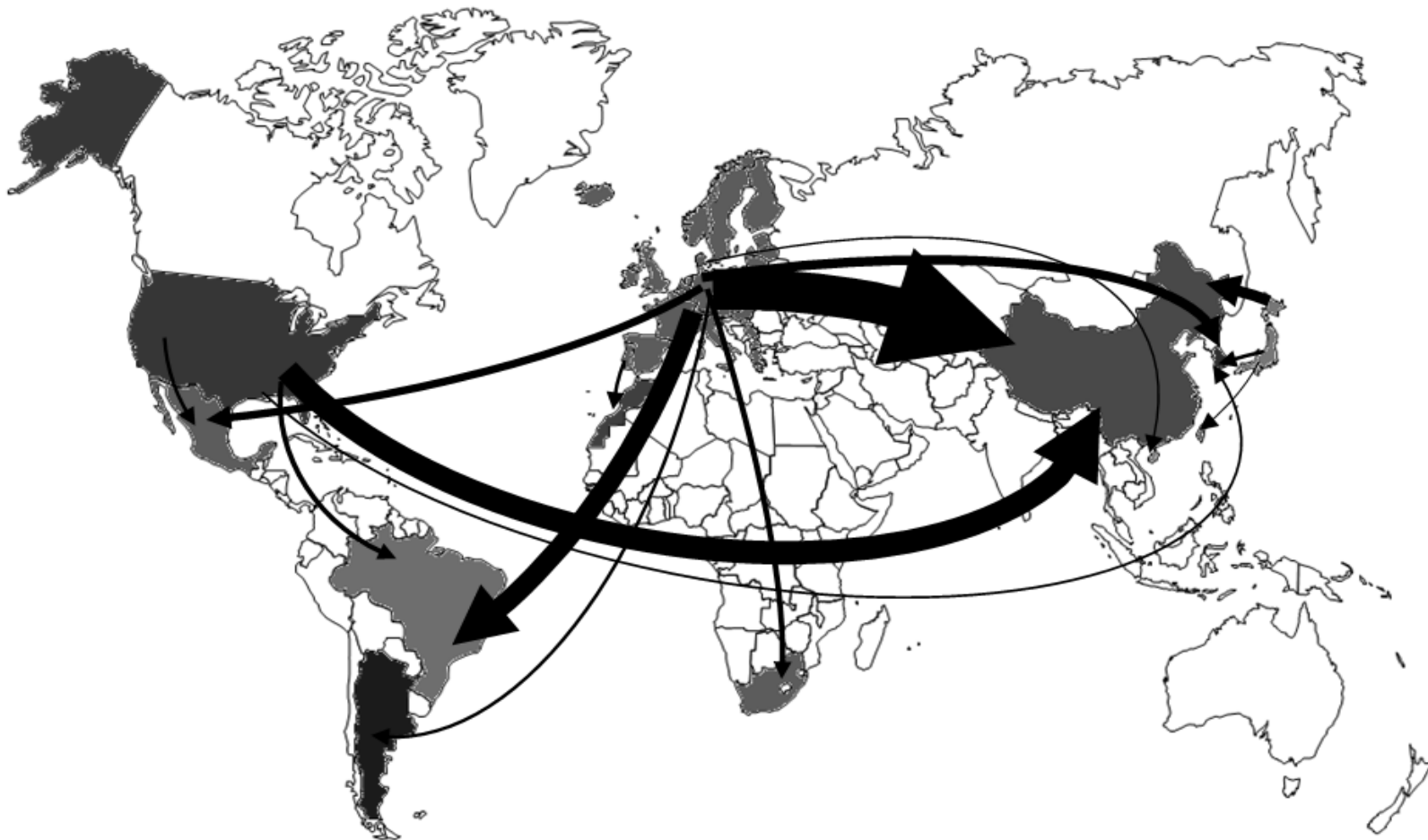

International Transfer of wind power technology, 1988-2007,

OECD 2010

# EXAMPLE: PRODUCT TO LICENSE OR SELL



**TEIJIN Limited**

## ECOPET(TM)

ECOPET(TM) is a recycled polyester fiber made from used plastic bottles by material recycling. We recommend this for environmentally-friendly products requiring green procurement. ECOPET(TM) gets the Oeko-Tex(R) Standard 100 certification as staple fibers.

**Published by** TEIJIN LIMITED

**Published:** JUNE 20, 2013

**Edited:** JUNE 20, 2013

## Technology features

**Resources to be saved or improved**

Oil

**Benefits**

Polyester fiber which melted the collected pet and was reproduced by material recycling technology. It is the stable high quality. Compared with the case where petroleum is used as materials, there is 47 percent with CO2 emissions and there is 33 percent of reduction effect with energy consumption. The assessment includes CO2 emitted by incinerating products that are not collected. Source, An estimate by Industry-information Collaboration Research Center Corp.

**Technology type**

Material

**Technical fields**

Waste management > Reuse of waste materials

**Stage of development**

At usable level



# GET INVOLVED

- Become a Partner and shape the further development of WIPO GREEN
  
- Register to:
  - communicate your green innovation and technology needs
  - advertise your inventions, technologies, products and services
  - connect with the innovation and business communities globally

