



WIPO | HAGUE

The International
Design System



The Hague System for the International Registration of Industrial Designs

Jonah Asher
Hague Development and Promotion Section
The Hague Registry

Geneva,
July 19, 2018

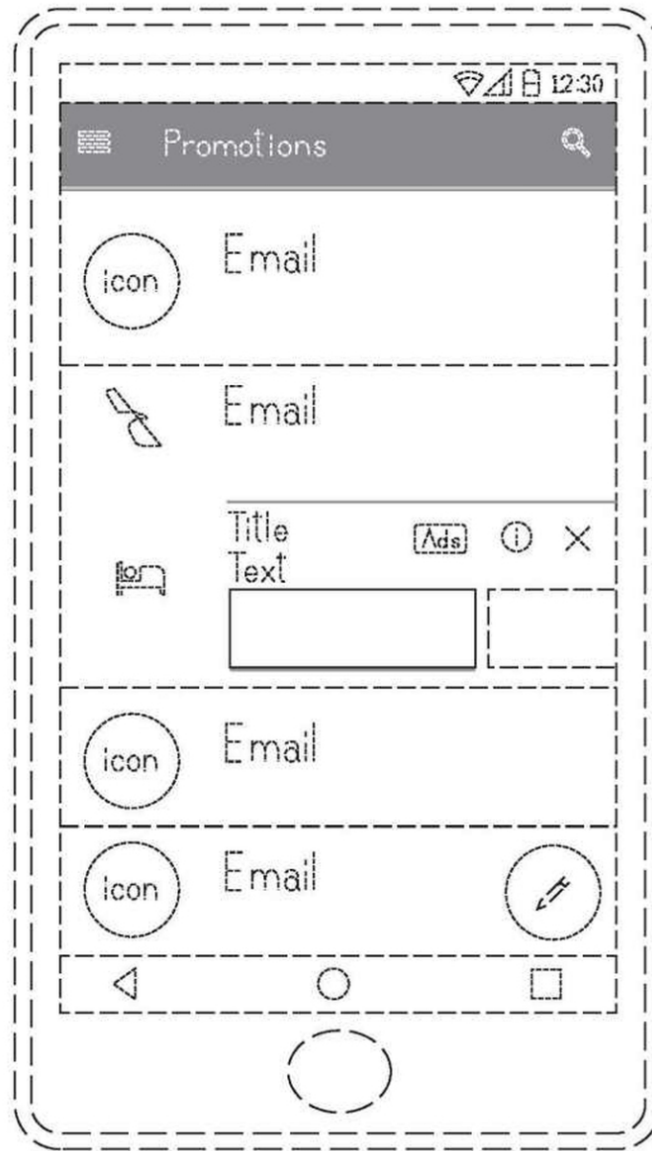





Industrial Designs

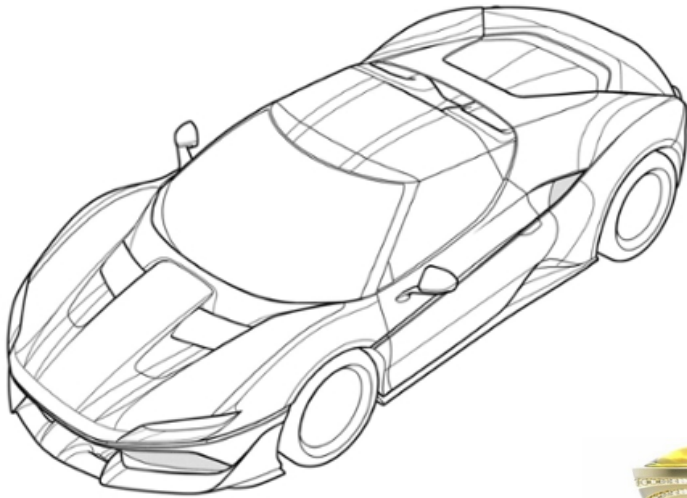

DM/097114



DM/090520



DM/083330

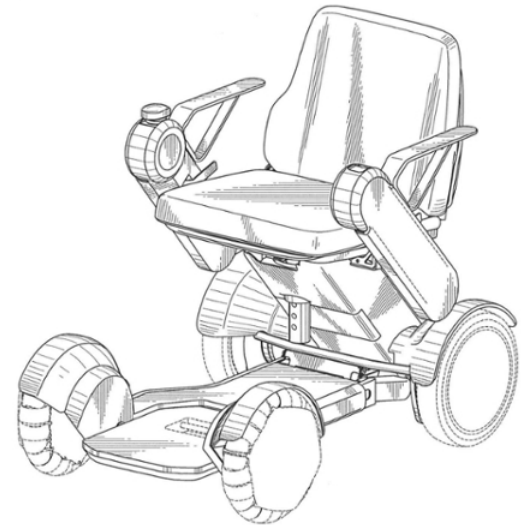

DM/097600

Why Protect Industrial Designs?

Prevents
unauthorized
copying or
imitation

Strengthens
competitive
position

Encourages
fair
competition

Profitability

SUCCESS

General Overview of the Hague System



Basic features and advantages



Legal framework



Going global – geographical scope



Some statistics



Latest developments and
upcoming features



Basic Features and Advantages of the Hague System

Hague System: A Simple But Timeless Concept

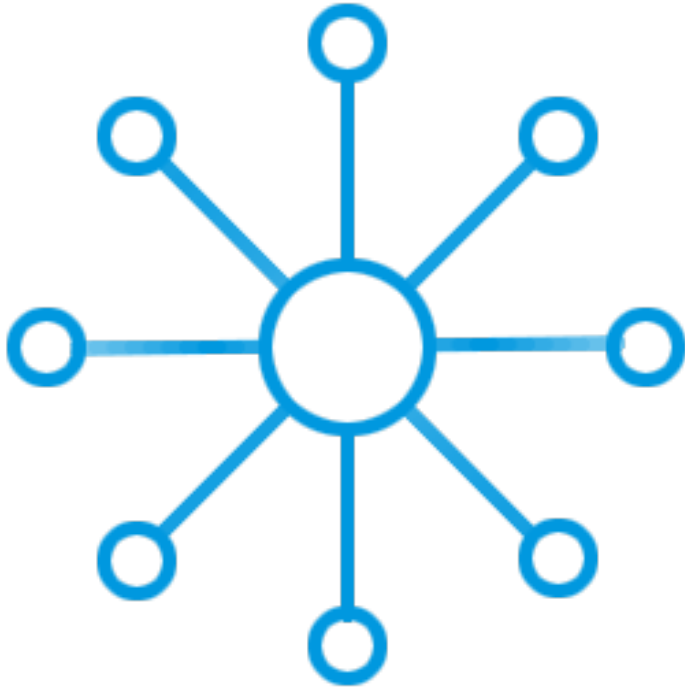

Centralization of
acquisition and
maintenance

Independent filings vs. Hague Route

Direct/Paris Route

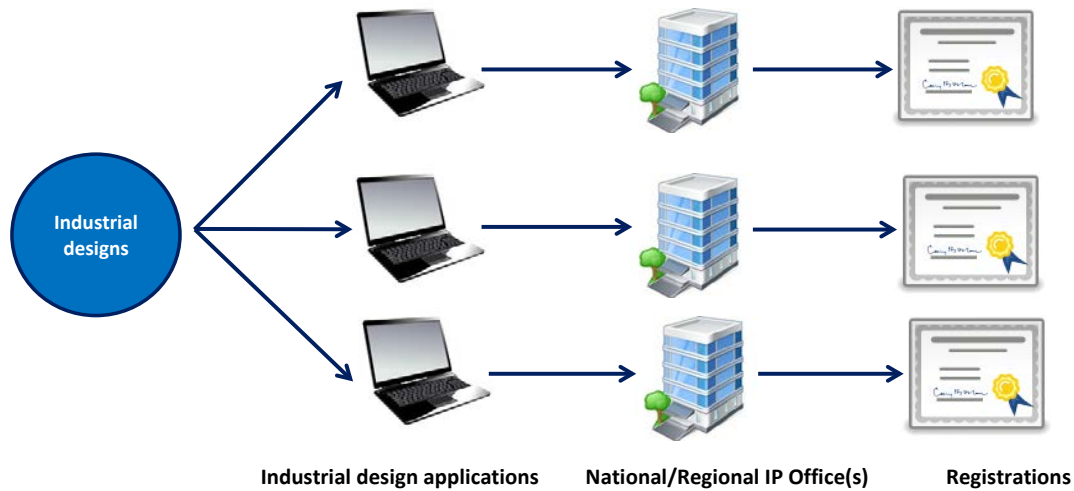

The Hague System



Main Features of the Hague System

1

- Application
- Language (EN, ES, FR)
- Set of fees & currency (CHF)
- International Registration
- Renewal

Main Features of the Hague System



Designs in one application

Main Features of the Hague System



Contracting Parties¹

1. Entry into force (Canada): November 5, 2018

Main Features of the Hague System



Simplicity



Cost-Effectiveness



Efficiency



Flexibility

Who Can Use the System?

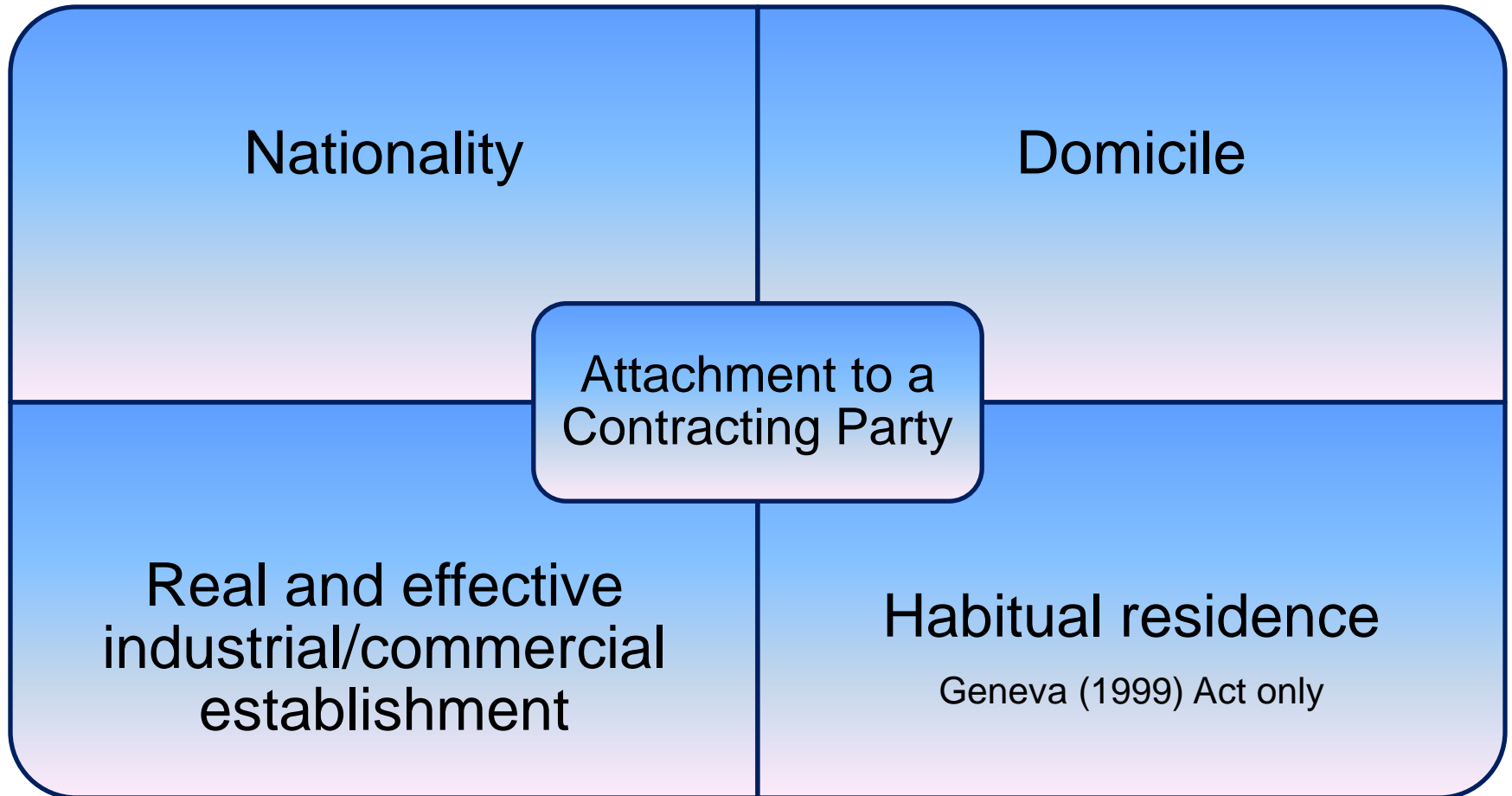

What is the Hague System?

One to many relationships

- File a single international application for a single international registration in which one or more Contracting Parties are designated

“Bundle of rights”

- If no refusal, the resulting international registration has the effect of a grant of protection in each designated Contracting Party

The Hague System is a Procedural Arrangement

Issues such as:



the conditions for protection



the refusal procedure to be applied when deciding whether a design may be protected



the rights which result from protection

are governed by the law of each Contracting Party designated in an international registration

The International Application

In English, French or Spanish

May be filed directly with the International Bureau through the E-filing interface but also on paper

May comprise several different designs up to a maximum of 100 if they belong to the same class of the International Classification (Locarno)

One set of fees (in CHF) is to be paid

The Hague System Procedure: Role of the International Bureau

Formal examination

Recording in the International Register

Sending the certificate to the holder

Publication in the International Designs Bulletin

Notification to members through the publication in the Bulletin

If the International Bureau finds that the international application does not fulfill the applicable requirements, it invites the applicant to make the required corrections within three months from the date of invitation sent by the International Bureau.

International registration has the same effect as a regularly-filed application in all designated Contracting Parties.

The Hague System Procedure (II)

Refusal by a designated Contracting Party

on same substantive grounds as for national/regional filings

must be communicated within time limit

effect limited to territory of the member that has refused

International registration (where not refused)

no refusal = same rights as a local design registration

a bundle of independent national/regional rights

advantages of central management

The Hague System Procedure (III)

Duration of protection:
five years

Renewable at least once (1960 Act) or twice (1999 Act)

Longer renewal period, if allowed by the law of the designated Contracting Party

General Advantages of the Hague System



Hague System (international route)

one Office for filing
one language
one currency
one international registration
one renewal
one modification
foreign attorney or agent
(first needed if refused)

National/regional route

many Offices for filing
many languages
many currencies
many registrations
many renewals
many modifications
foreign attorney or agent
(first needed at filing)



Legal Framework



- **Common Regulations (1996), last revised: January 1, 2017 (in force)**
- **Administrative Instructions (2002), last revised: July 1, 2014**
- **National Laws and Regulations**



Going Global – Geographical Scope of the Hague System

Hague System Growth

■ 1999 Act

■ 1960 Act

2008

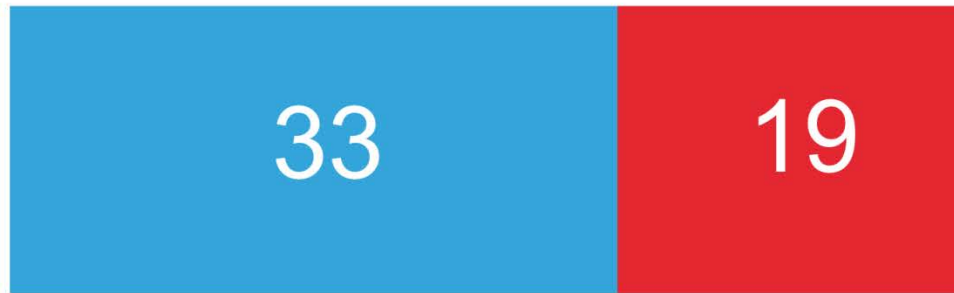

52

Contracting Parties

Hague System Growth

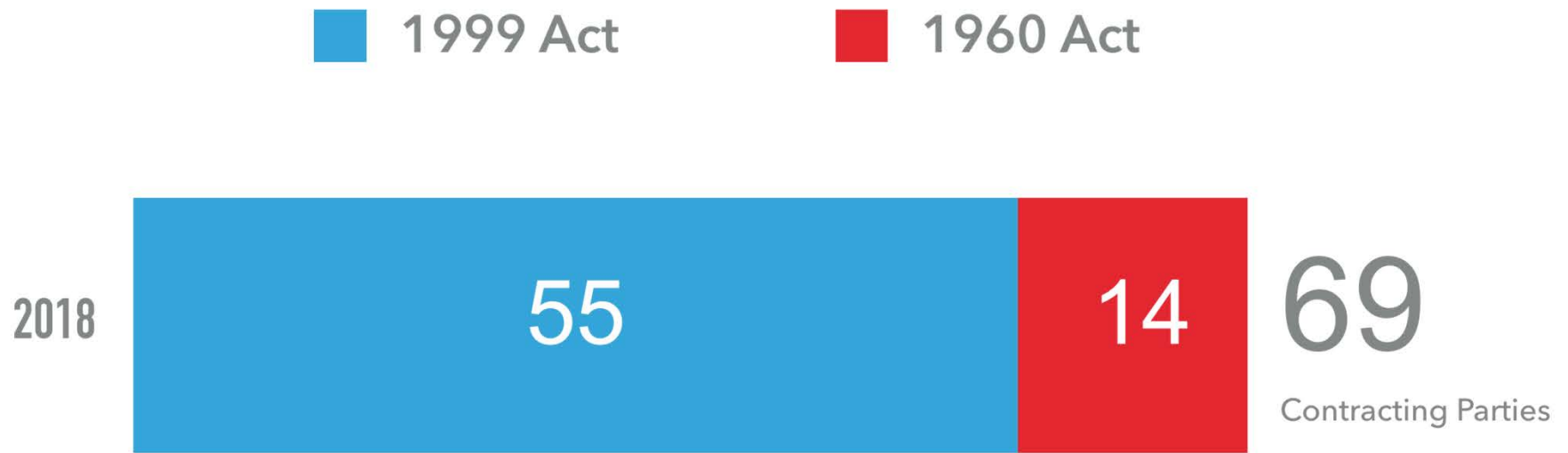

1. Entry into force (Canada): November 5, 2018

Hague Union

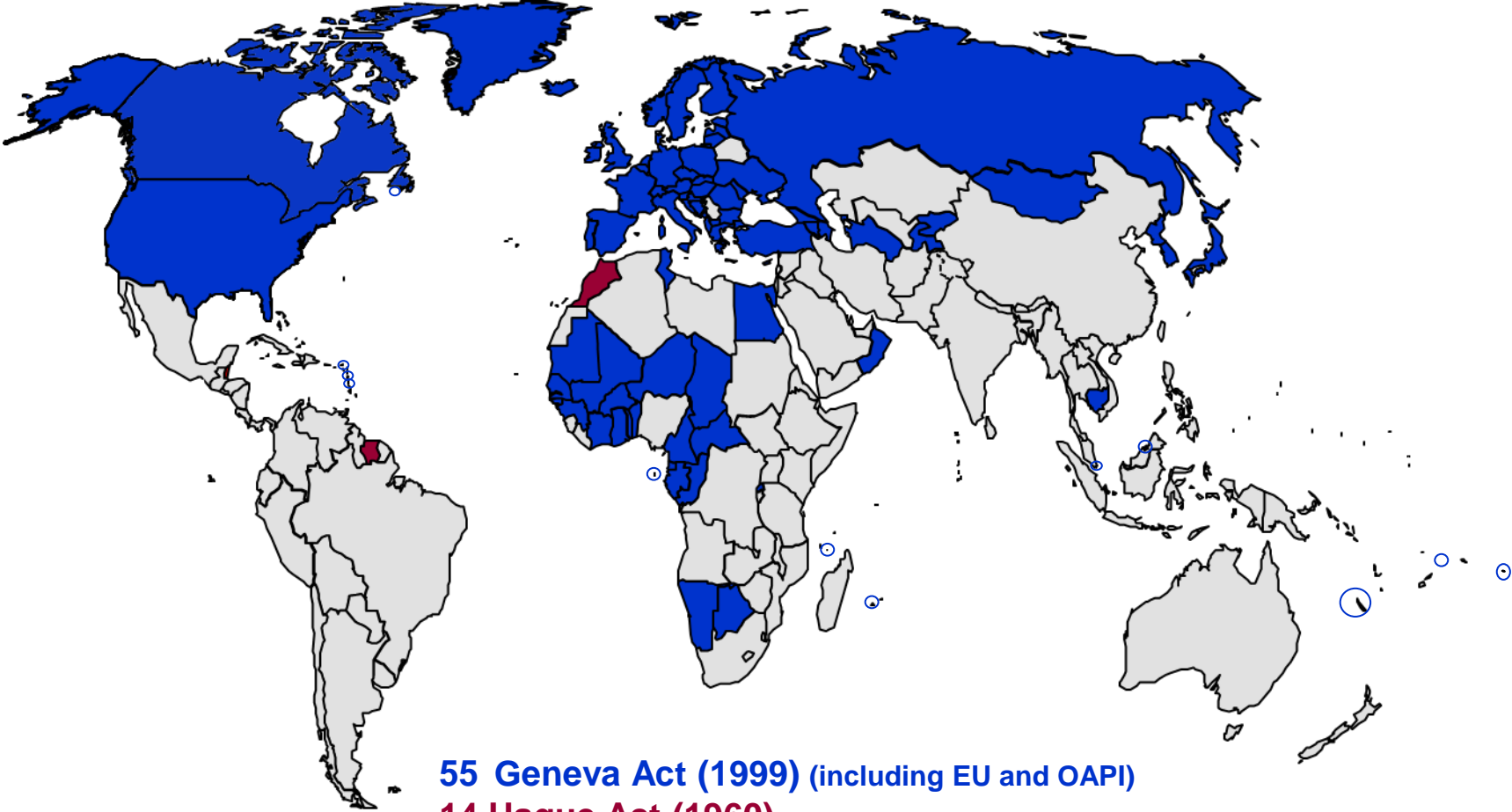

55 Geneva Act (1999) (including EU and OAPI)

14 Hague Act (1960)

69 Contracting Parties¹

1. Entry into force (Canada): November 5, 2018

Hague Union Members According to the Most Recent Applicable Act

Geneva Act (1999)

•African Intellectual Property Organization, Albania, Armenia, Azerbaijan, Bosnia and Herzegovina, Botswana, Brunei Darussalam, Bulgaria, Cambodia, Canada¹, Croatia, D.P.R. of Korea, Denmark, Egypt, Estonia, European Union, Finland, France, Georgia, Germany, Ghana, Hungary, Iceland, Japan, Kyrgyzstan, Latvia, Liechtenstein, Lithuania, Monaco, Mongolia, Montenegro, Namibia, Norway, Oman, Poland, Republic of Korea, Republic of Moldova, Romania, Russian Federation, Rwanda, Sao Tome and Principe, Serbia, Singapore, Slovenia, Spain, Syrian Arab Republic, Switzerland, Tajikistan, the former Y.R. of Macedonia, Tunisia, Turkey, Turkmenistan, Ukraine, United Kingdom and the United States of America (54)

Hague Act (1960)

•Belgium, Belize, Benin, Côte d'Ivoire, Gabon, Greece, Italy, Luxembourg, Mali, Morocco, Netherlands, Niger, Senegal and Suriname (14)

1. Entry into force (Canada): November 5, 2018

Geneva Act (1999)

Recent Accessions



Canada¹
(July 16, 2018)



United Kingdom
(March 13, 2018)



Russian Federation
(November 30, 2017)



The Kingdom of Cambodia
(November 25, 2016)



D.P.R. of Korea
(June 13, 2016)



United States of America
(February 13, 2015)



Japan
(February 13, 2015)



Republic of Korea
(March 31, 2014)

Potential Accessions



China



Morocco



ASEAN countries



Israel



Mexico



Madagascar

1. Entry into force (Canada): November 5, 2018



Latest Developments

Latest Developments



Regularization of international applications online
(since March 2016)



Guidance on reproductions



New Hague Express Database since January 2015



Improvement of the E-filing interface



Developments in the legal framework



Global Design Database since January 2015

Guidance on Reproductions

Disclosure criteria may differ depending on jurisdiction. This new Guidance is a useful tool to help applicants forestall possible refusals on the ground of insufficient disclosure of an industrial design by Examining Offices.

Prepared in consultation with Examining Offices under the Hague System and several user organizations

Detailed guidance on how to prepare and provide reproductions to overcome the most common refusal issues

- Not enough views
- Unclear representations of the claimed design
- Unclear relief or contours of surfaces of a three-dimensional product
- Difference in form/color between the representations of the claimed design

Information on which guidance should be taken into account when designating specific Contracting Parties

Not self-sufficient or all inclusive

Reproduction Examples That Have Passed the Disclosure Test Before All Concerned Offices (1)

1.1



1.1) Perspective

1.2



1.2) Perspective

D089713 – Hilti Aktiengesellschaft

1.3

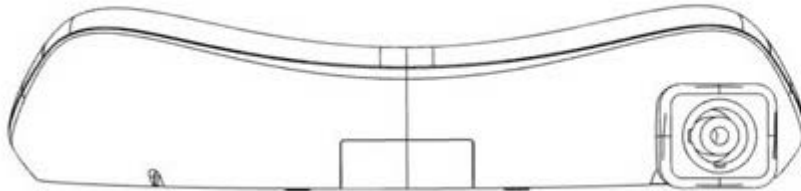

1.3) Back

1.4

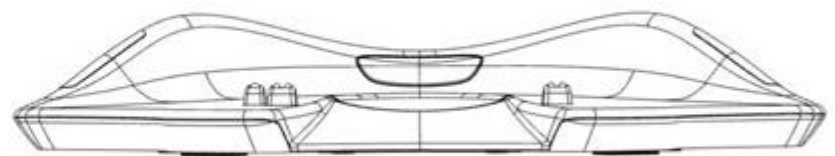

1.4) Front

D087535 – Softbank Robotics

Reproduction Examples That Have Passed the Disclosure Test Before All Concerned Offices (2)

1.2



1.2) Back

1.3



1.3) Left

1.4



1.4) Right

D089858 – Ninebot (Beijing) Tech

1.1

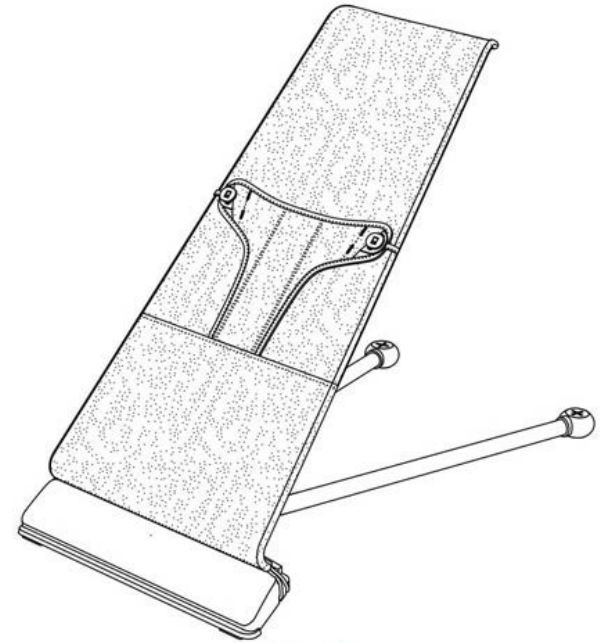

1.1) Perspective

D086974 – Babybjörn AB

Hague Express Database

Hague Express

The Hague Express Database, updated weekly, includes bibliographical data and, as far as international registrations governed exclusively or partly by the 1999 and/or by the 1960 Act(s) of the Hague Agreement are concerned, reproductions of industrial designs relating to international registrations that have been recorded in the International Register and published in the International Designs Bulletin as of issue No. 1/1999. International registrations that have lapsed are not removed from the database.

SEARCH BY

Design Names Numbers Dates Country

Indication of Products

= watch

Locarno

=

Description

=

search

CURRENT SEARCH

PROD:watch

FILTER BY

Designation Locarno Class Reg. Date * Contracting Party *

CH	1,535	MC	1,131	TN	991	MA	963	LI	960
FR	894	DE	890	IT	889	EG	887	BX	851
BE	851	NL	851	LU	851	ES	813	ME	684
MK	683	GR	666	MD	642	MN	634	SG	611
TR	594	UA	591	ID	586	EM	583	KP	556
RS	523	VA	489	SI	462	CW	409	BQ	408
SX	406	GE	380	RO	378	KG	376	BZ	364

Display: List

Sort: Count - desc









filter

1 - 10 / 1,627

edit columns

10 per page

1 / 163

Reg. No	Holder	Reg. Date	Locarno Cl	Ind. Prod.	Des.	Designs	Image
DM/046674	HYSEK JÖRG	1999-02-03	03-01	Etui pour montre	AN,EG,ES,ID,MA,TN,V	1	
DM/082429	CARTIER CREATION STUDIO SA	2013-12-13	10-02	1. Watch; 2. Watch case; 3. Watch dial; 4. Watch; 5. Watch bracelet; 6. Watch dial; 7. Watch dial	CH,EM,SG,TR	8	
DM/083367	FRANCK MULLER WATCHLAND SA	2014-04-09	10-02	1. Montre-bracelet	EM,MC,SG	1	
DM/065362	SWATCH AG (SWATCH SA) (SWATCH LTD.)	2004-05-12	10-02	1. Montre-bracelet	BQ,CW,EG,ID,SX,TN,I	1	
DM/073485	BÉDAT & CO SA	2010-03-26	10-02	Watch	BX,KP,CH,EM,LI,OA,S	1	
DM/073351	HUBLOT SA, GENÈVE	2010-03-18	10-02	Watch	CH,EM,SG	1	
DM/073317	OMEGA SA (OMEGA AG) (OMEGA LTD.)	2010-02-12	10-02	Watch	BZ,MA,MC,ME,AL,AM,I	1	
DM/072570	ALEXIS BARTHELAY (SOCIÉTÉ ANONYME)	2009-10-20	10-02	Watch	MA,CH,EG,EM,OM,SG	1	

Global Design Database

Global Design Database A world-wide collection of industrial designs data; including WIPO Hague registrations and information from participating national offices.

SEARCH BY

Design Names Numbers Dates Country

Indication of Products ▾ =

Design class ▾ =

Description ▾ =

search ↗

FILTER BY

Source Designation Locarno Class Reg. Year *

CA Designs	166,387	ES Designs	97,240	JP Designs	544,785	NZ Designs	47,479
US Designs	806,481	ID Designs	56,693	WO Designs	55,795		

Display: List ▾ Sort: Value - asc ▾

filter ↕

1 - 10 / 1,774,860

Display: 10 per page options

1 / 177,486

Reg. No	Source	Holder	Reg. Date	Locarno Cl.	National Cl.	Ind. Prod.	Designations	Designs	Image
D0807718	USID	SUMITOMO ELECTRIC HARDMETAL CORP.	2018-01-16	08-03	US.D08-020	Cutting tool	US	1	
D0807764	USID	Shallcross; Richard Scott	2018-01-16	10-04	US.D10-065	NPT/UN thread identification kit	US	1	
D0807777	USID	Fitbit, Inc.	2018-01-16	11-01	US.D11-094, US.D10-128	Receptacle insert for a wearable fitness band system	US	1	
D0807772	USID	EASYREAD TIME TEACHER LIMITED	2018-01-16	10-07	US.D10-126	Clock	US	1	
D0807795	USID	Brunswick Corporation	2018-01-16	12-16	US.D12-150, US.D09-434,	Shock absorbing hub assembly for a marine propulsion apparatus	US	1	

Improvement of the E-Filing Interface



Receive and download notifications from the IB relating to international applications



Send corrections to irregularities or defects



Retrieve in real-time current status of IA



Indication of access code obtained from the IP office of first filing, so that the IP office of the designated Contracting Party is able to access the priority document via the WIPO Digital Access Service (DAS).

E-Filing Portfolio Manager

Welcome USER

Portfolio Status

Number of application(s) sent: 17
Number of application(s) unsent: 11











E-Filing Manager Menu

E-Filing Application
E-Filing Communications (0 unread)
E-Filing Tutorial

File an international application | **Sent application(s)** | Unsent application(s)

Application(s) sent to the International Bureau

(1 of 2)

	WIPO reference	Filing date	Applicant(s)	Locarno Class	Designation(s)	Status	A.R.
1	WIPO3985	21/03/2018	Mitsubishi Denki	7	BG, EG, EM, JP, KR, NO, SG, US	Examination	
2	WIPO4162	30/08/2016	Pikachu	14	AM, BA, DK, EM, JP, KR, NO, US	Examination	
3	WIPO3966	21/08/2016	Yoshihisa Oka	12	BA, EM, JP, KR, NO, SN, US	Examination	
4	WIPO4161	19/08/2016	Kitty Chan	17	BA, EM, IT, KR, LT, US	Examination	
5	WIPO4155	17/08/2016	Ace Electronics	12	DE, EM, JP, MA, MN, SG, US	Examination	
6	WIPO4153	28/07/2016	Shokora Usagi	21	BG, EM, HR, JP, ME, NA, NO, US	Examination	
7	WIPO4133	21/07/2016	Nichiban	15	AL, BA, BG, CI, GH, JP, KR, MC, NA, RS, SR, TN, US	Examination	
8	WIPO4132	20/07/2016	Pokemon	6	BX, DE, EM, ES, GA, GR, JP, KR, LI, NO, SR, US	Examination	
9	WIPO3968	22/01/2016	Mitsubishi Motors	12	DE, EM, JP, NO, US	Examination	
10	WIPO3960	22/01/2016	Ken Watanabe	12	BG, BX, BZ, DE, FR, GE, GR, JP, KR, MD, SG, TR, US	Examination	

(1 of 2)

E-Filing Interface



HAGUE
The International Design System

WIPO reference
72284

Information regarding data entry
The international application must indicate at least one applicant

Information concerning the applicant

Name and address

Full name* Telephone

Street address* Fax

Zip/Post code E-mail address

Town* Address of website

Country*

(*) Compulsory

Entitlements **

Nationality

Domicile

Real and effective industrial or commercial establishment

Habitual residence

(**) Indicate at least one entitlement

Applicant's Contracting Party (ACP)

Applicant's Contracting Party

Return to Portfolio Manager

Save Cancel

Applicant(s) registered

(1 of 1) << < > >>

Name	Address	Nat.	Dom.	Estab.	Res.	ACP	Act(s)	Actions
No records found								

(1 of 1) << < > >>

Developments in the Legal Framework

Termination of the London (1934) Act of the Hague Agreement Concerning the International Deposit of Industrial Designs took place in October 2016

Amendments to the Common Regulations Under the 1999 Act and the 1960 Act of the Hague Agreement concerning a safeguard against non-delivery of an electronic communication entered into force on 1.1.2017

Entry into force of the eleventh edition of the Locarno Classification on 1.1.2017

New Hague Information Tools

■ New functionalities available at www.wipo.int/hague

- **Contact Hague Form**

1. Single point of contact for users;
2. Automated and history viewable



- **Hague Member Profiles Database**

1. Compilation of data;
2. Search tool





Some Statistics

International Registrations – 2017

INTERNATIONAL REGISTRATIONS INSCRIBED

5,041

**DESIGNS CONTAINED IN INTERNATIONAL
REGISTRATIONS INSCRIBED**

19,241

International Registrations – 2017

COMPARED TO 2016 (REGISTRATIONS)

3.66% ↓

COMPARED TO 2016 (DESIGNS)

9.3% ↑

International Applications – 2017

INTERNATIONAL APPLICATIONS

5,213

**DESIGNS CONTAINED IN INTERNATIONAL
APPLICATIONS**

19,429

International Applications – 2017

COMPARED TO 2016 (APPLICATIONS)

6.27% ↓

COMPARED TO 2016 (DESIGNS)

3.8% ↑

2017 – Top Classes in International Registrations

TOP 5 CLASSES

Number of designs in applications and share of total

2,045

FURNISHING



10.5%

2,008

**RECORDING AND
COMMUNICATION
EQUIPMENT**



10.3%

1,472

**MEANS OF
TRANSPORT**



7.6%

1,345

**LIGHTING
APPARATUS**



6.9%

1,339

**CLOCKS AND
WATCHES**



6.9%

International Registrations Recorded 2010-2017

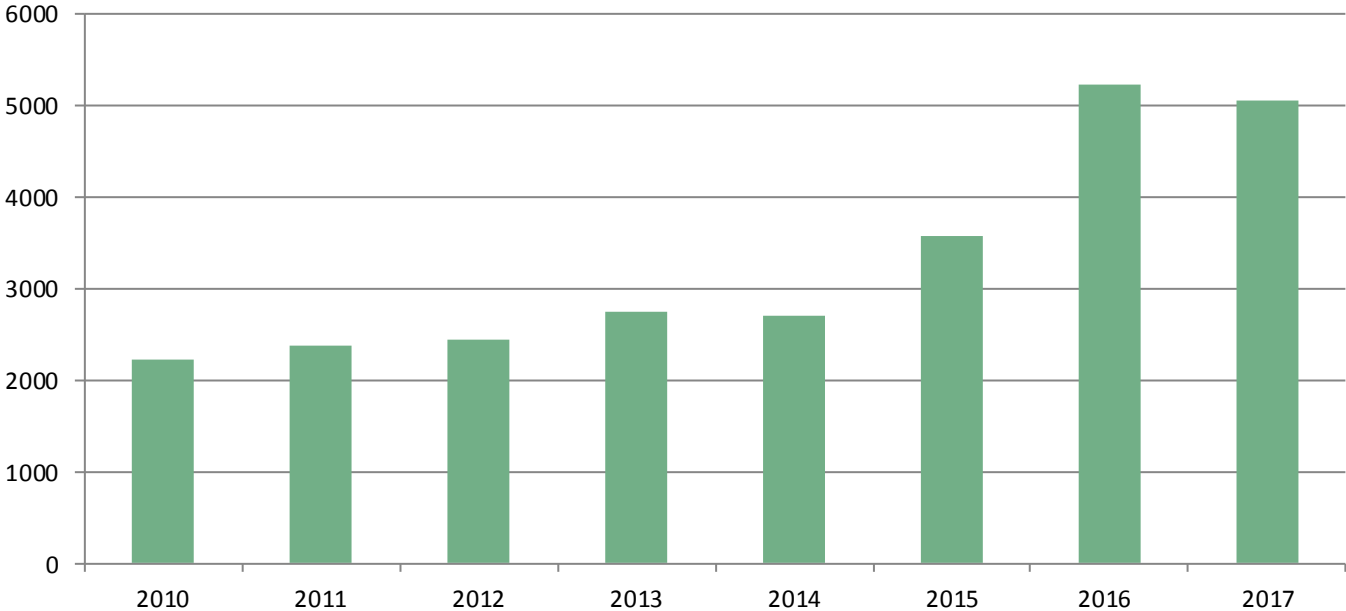

International Registrations Recorded

2010 2216 2011 2363 2012 2440 2013 2734 2014 2703 2015 3581 2016 5233 2017 5041

Growth

11.7% 6.6% 3.3% 12.0% -1.1% 32.5% 46.1% -3.7%

Designs in International Registrations 2010-2017

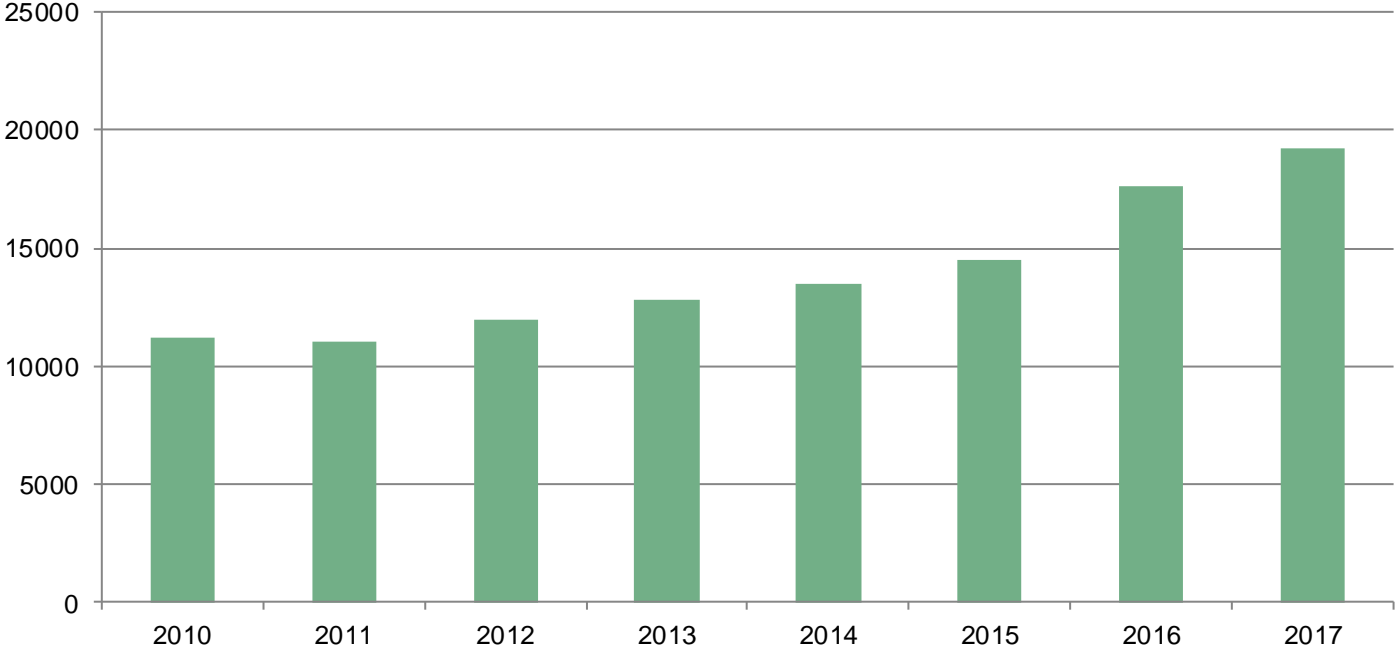

Designs in Int. Registrations	11238	11077	11971	12806	13504	14484	17601	19241
Growth	11.7%	-1.4%	8.1%	7.0%	5.5%	7.3%	21.5%	9.32%

Designs per International Registration (2017)

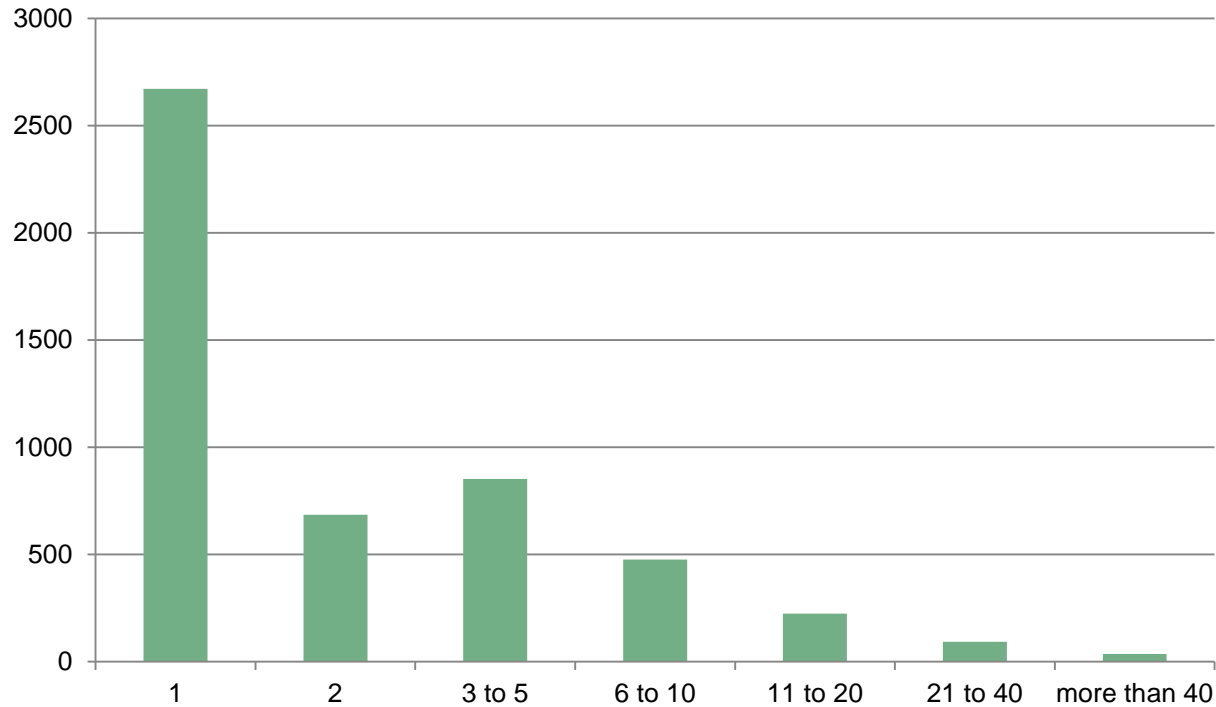

International Registrations	2671	686	853	476	225	93	37
%	53%	14%	17%	9%	4%	2%	1%

Amount of Fees Paid per International Registration (2017)

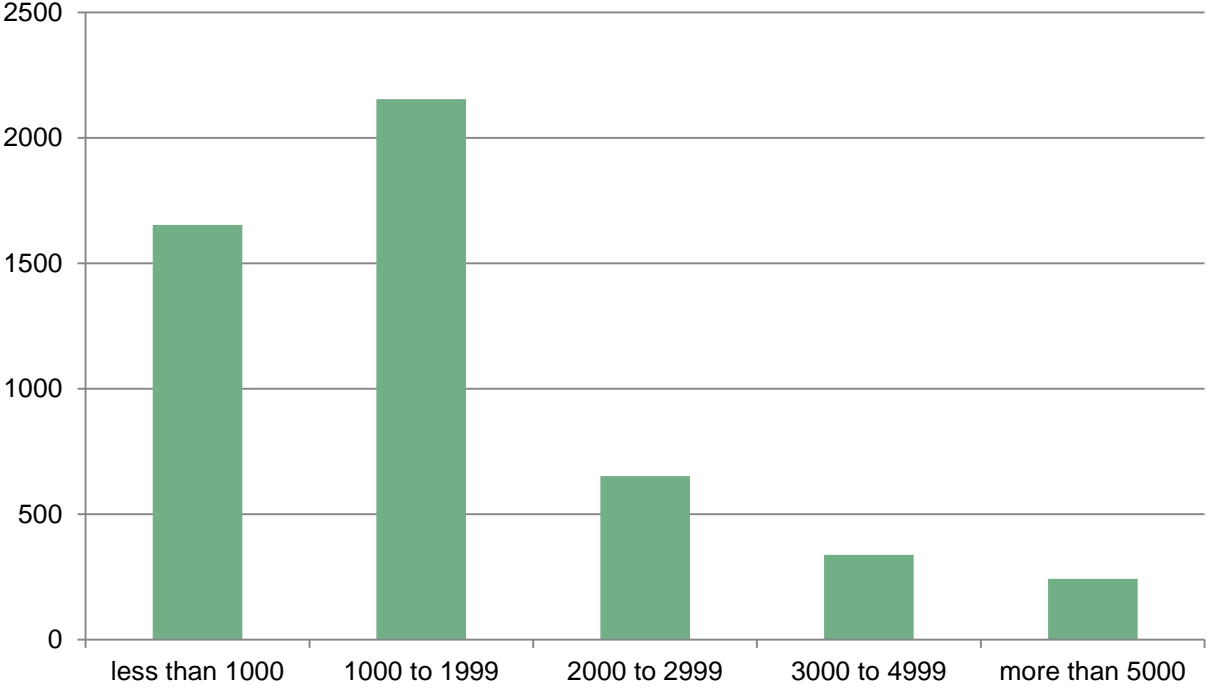

IR	1653	2154	652	339	243
%	33.8%	42.7%	12.9%	6.7%	4.8%

Designations in International Registrations (2017)

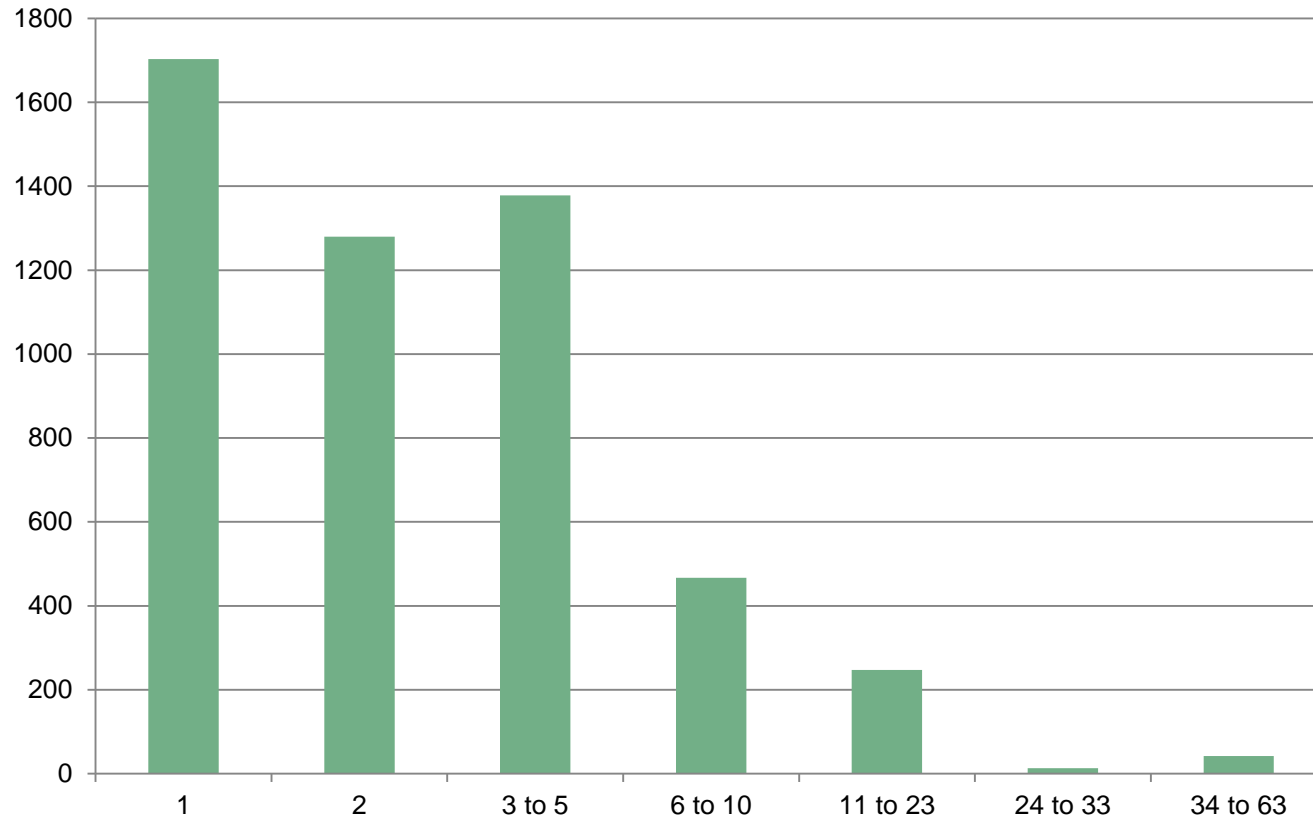

IR	1703	1280	1378	467	247	13	42
%	32.3%	25.0%	26.9%	9.1%	4.8%	0.3%	0.8%

Most Designated Contracting Parties in 2017 (international registrations)

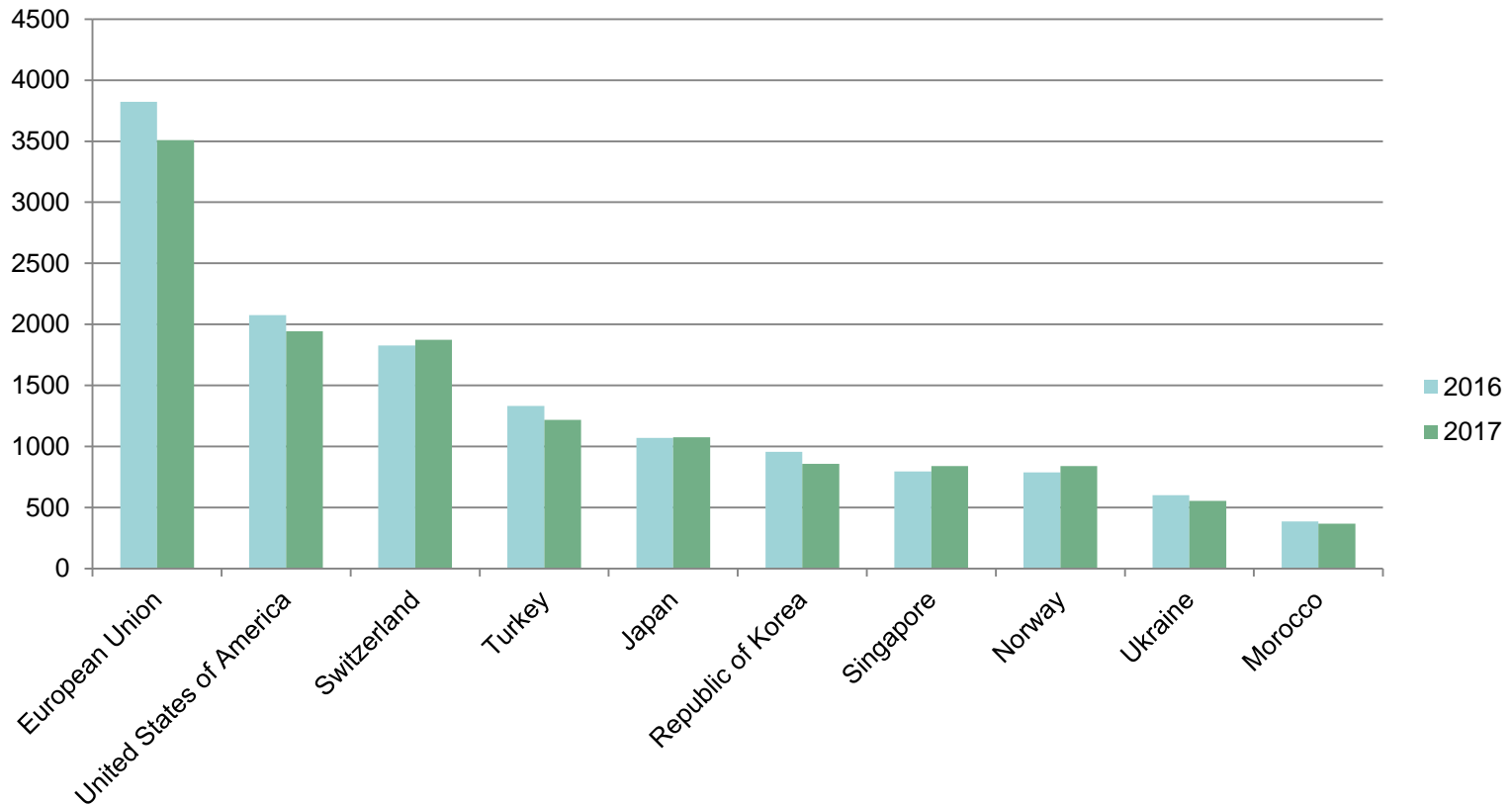

* Since the effective accession (May 13, 2015)

Most designated Contracting Parties in 2017 (number of designs recorded)

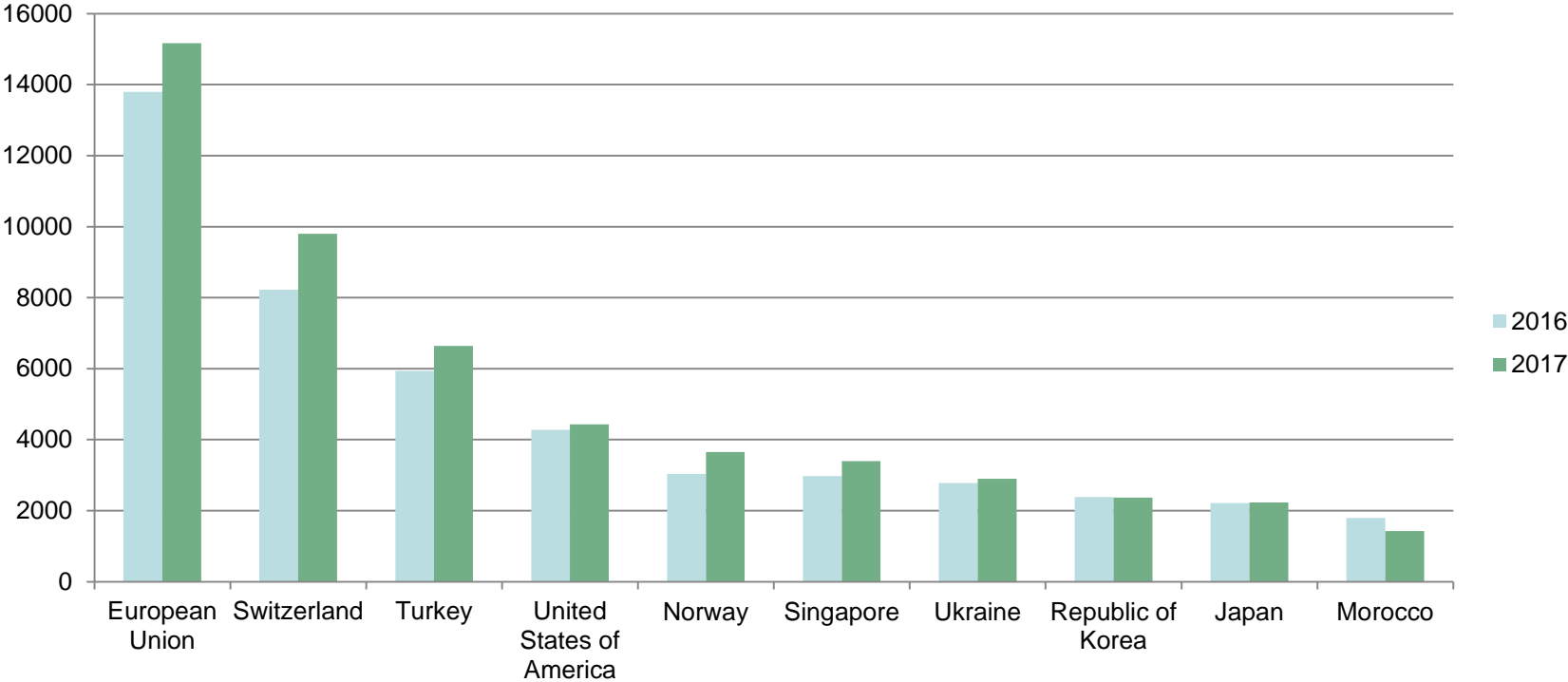

International Registrations in Force in the International Register (on December 31, 2017)

Industrial Designs

Right-holders
(9,805)



Industrial designs by right-holder	Number of right-holders	
1 design	6558	67.19%
2 designs	1360	13.87%
3-10 designs	1498	15.28%
11-100 designs	328	3.35%
> 100 designs	31	0.32%
All	9805	100.00%

Registrations in force
(34,324)

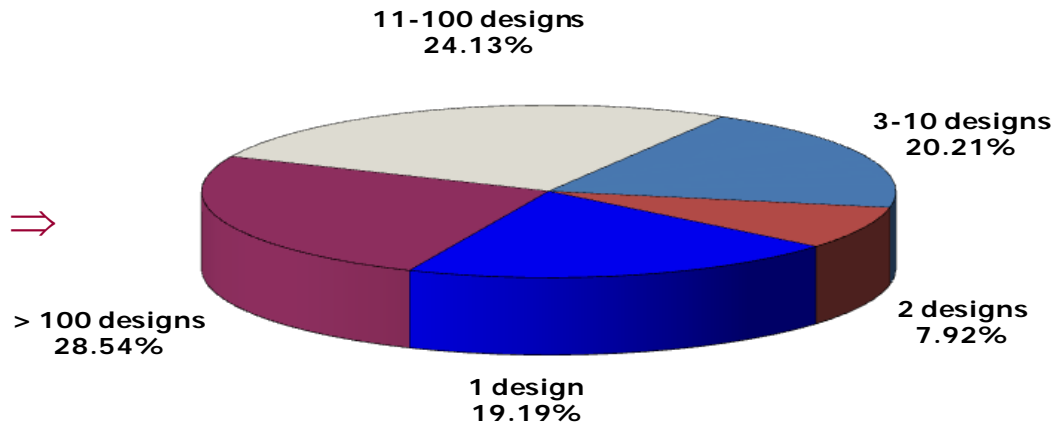

Origin of Holders per Designs in International Registrations by Applicant's Contracting Party - 2017

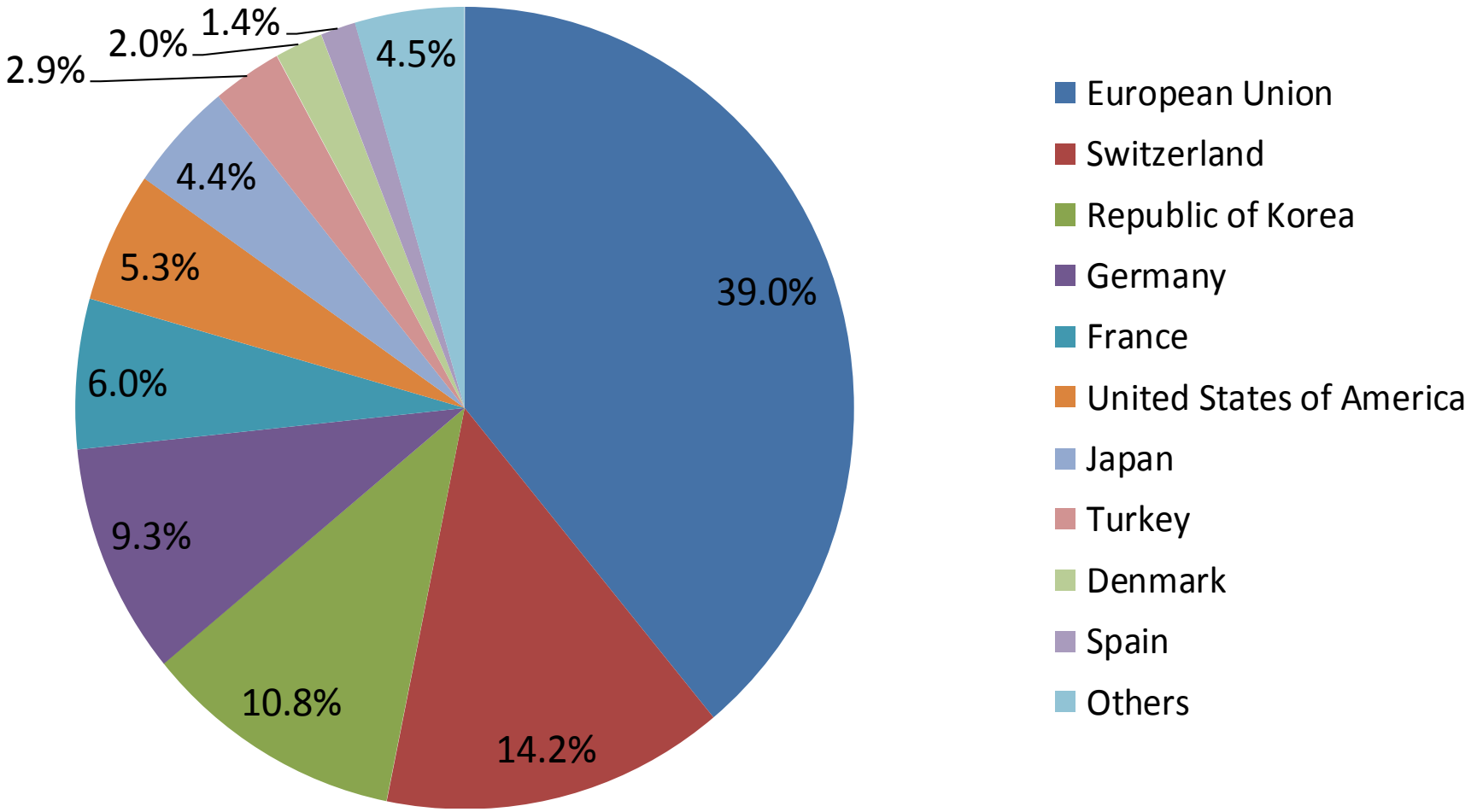

Origin of Holders per Designs in International Registrations by Country of the Address of the Holder- 2017

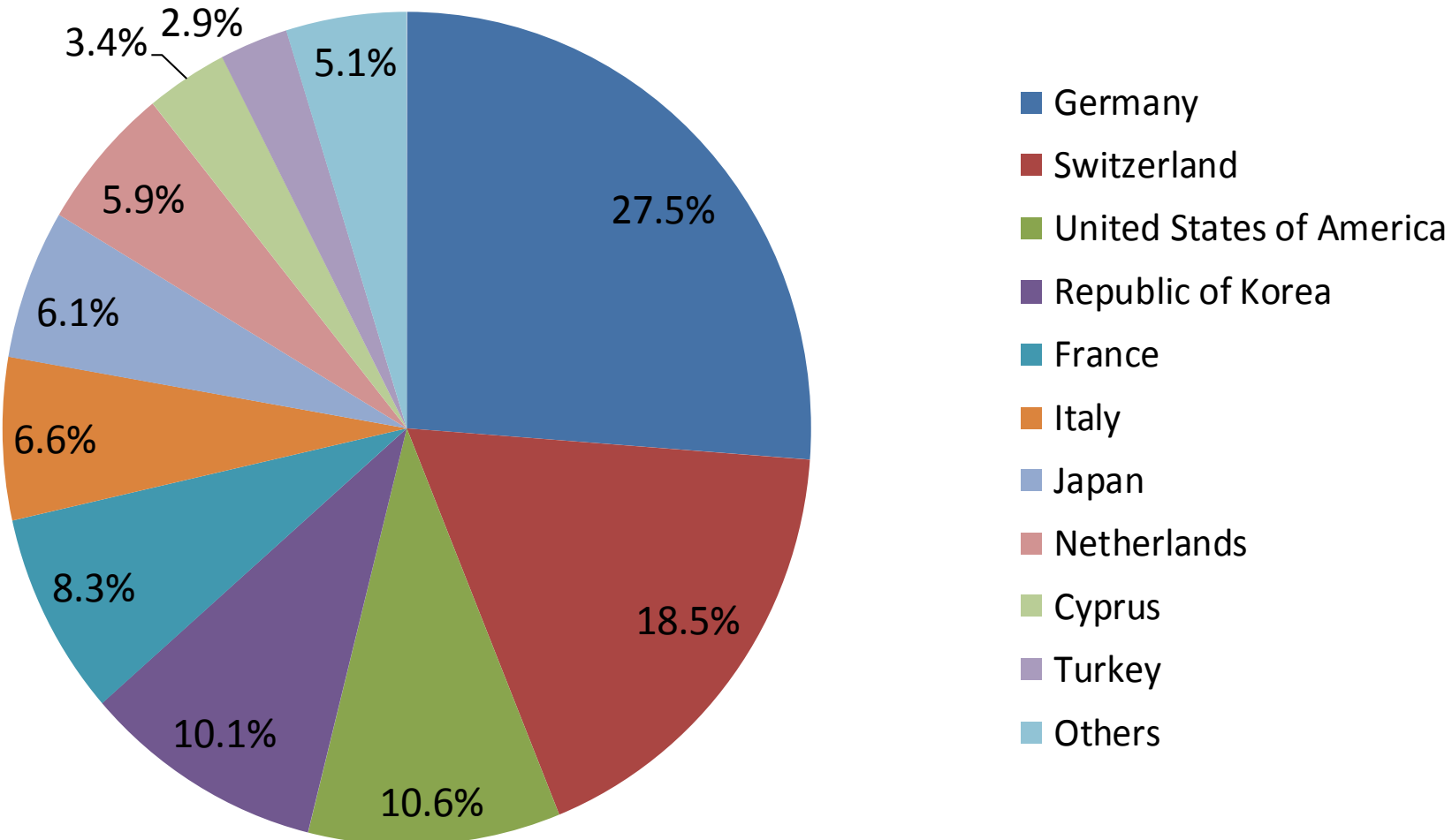

Thank You!

www.wipo.int/hague