



**WIPO | HAGUE**

The International  
Design System

# International Application and Examination

## Seminar on the Hague System for the International Registration of Industrial Designs

**Geneva**  
**April 9, 2015**

Kateryna Gurinenko, Examiner  
Operations Service, The Hague Registry

# Contents

- Contents of the application
  - Mandatory
  - Additional mandatory
  - Optional
- Reproductions
  - Disclaimer
  - Legends
- Product indication
- Description
- Locarno Classification
- New Accessions

# Mandatory contents

Filing date is affected

- Data concerning applicant
- Reproductions
- Product indication
- Indication of the Contracting Parties

# Additional mandatory contents

Registration date is affected

- Identity of the creator
- Description
- Claim

# Optional contents

- Description
- Identity of the creator
- Legends
- Appointment of the representative
- Priority claim
- Declaration of disclosure at an international exhibition
- Publication
  - Immediate
  - Deferred

# Reproductions

# Requirements concerning the reproductions

## Legal Framework

- Article 5 (1960 Act) / Article 5 (1999 Act)
- Rule 9 of the Common Regulations
- Administrative Instructions – Section 401- 405

# Requirements concerning the reproductions

## Common for paper and e-filing

- Industrial design alone
- Industrial design has to be shown against a neutral/plain background
- Technical drawings, with axes and dimensions are **not** acceptable
- Explanatory text or legends (in the reproduction) are **not** acceptable
- Edges cut at right angles



# Presentation of reproductions

Color or B&W

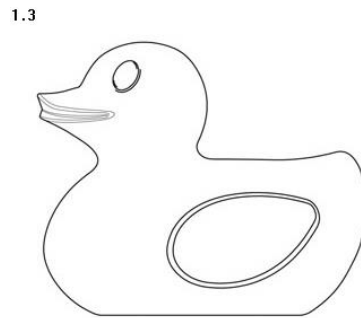

DM/084694 “Outdoor and indoor furniture with integrated lights”

Different colors different designs

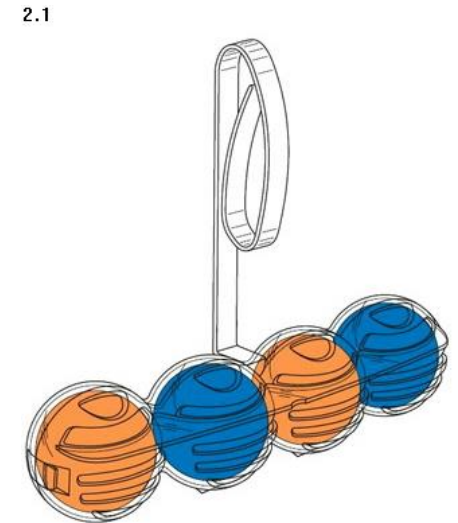

DM/078588 “Lavatory cleansing blocks”

# Representation of the industrial design



1.1

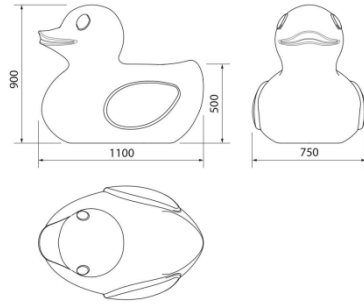

1.2

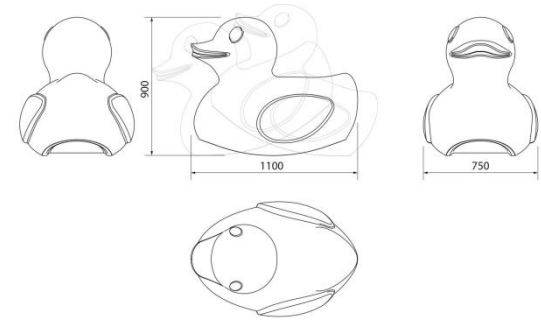

2.1



1.3

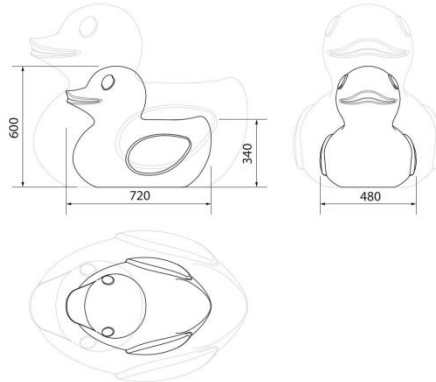

1.4

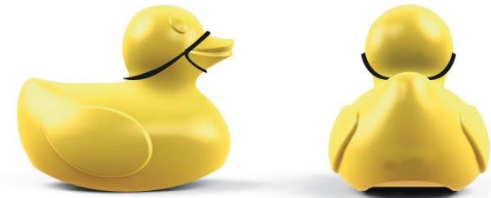

2.2



DM/084694 “Outdoor and indoor furniture with integrated lights”

# Representation of the industrial design



1.1



1.2



2.1



2.2

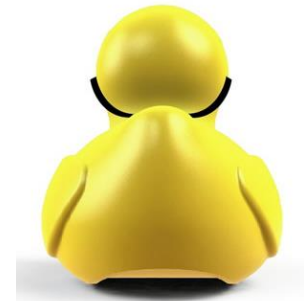

1.3

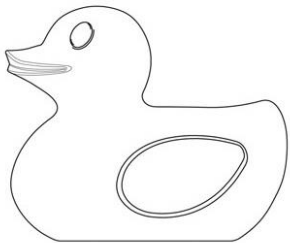

1.4

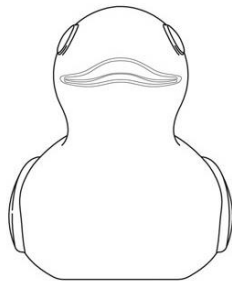

2.3



DM/084694 “Outdoor and indoor furniture with integrated lights”

# Amendments to the administrative instructions

(in force on July 1, 2014)

- Section 402(b): The dimensions of the reproductions
- Section 403(a)(ii) and (b): Disclaimers and matter that does not form part of the industrial design or the product in relation to which the industrial design is to be used
- Section 405(c): Legends

# Minimum and maximum sizes

## Paper application

- The dimensions of the representation of each design may not exceed 16 x 16 cm;  
*- for all reproductions*
- One of the dimensions of the representation of each design must be at least 3 cm:  
*Before – for all reproductions*  
*Now – at least for one of the reproductions*

# Minimum and maximum sizes

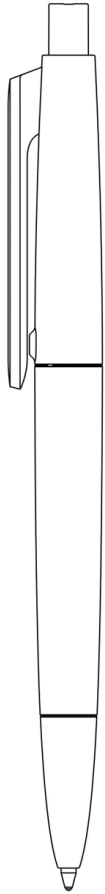

1.5

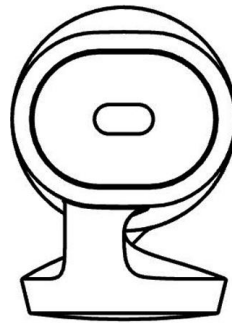

1.6



1.7

DM/084081 "Pen"

# Legends (indications of views) (Sections 402(c)(ii) and 405(c))

- Legends may NOT be shown in a reproduction.
- Legends may be provided in association with the numbering of the reproduction in a specific item.

# Legends: paper form

**10**

## DESCRIPTION OF THE REPRODUCTIONS (LEGENDS)<sup>6</sup>

Associate the number in the margin of your reproduction with the corresponding code:

1 Perspective; 2 Front; 3 Back; 4 Top; 5 Bottom; 6 Left; 7 Right; 8 Reference; 9 Unfolded; 10 Exploded;  
11 Cross-sectional; 12 Enlarged; 00 Other (limited to 50 characters)

No.	Code	Legend (max 50 characters, where code 00 has been indicated)	No.	Code	Legend (max 50 characters, where code 00 has been indicated)	No.	Code	Legend (max 50 characters, where code 00 has been indicated)

If the space provided is not sufficient, check this box and use a continuation sheet.

<sup>6</sup> Necessary for a designation of Japan and the United States of America.



# Legends: 7 Basic views

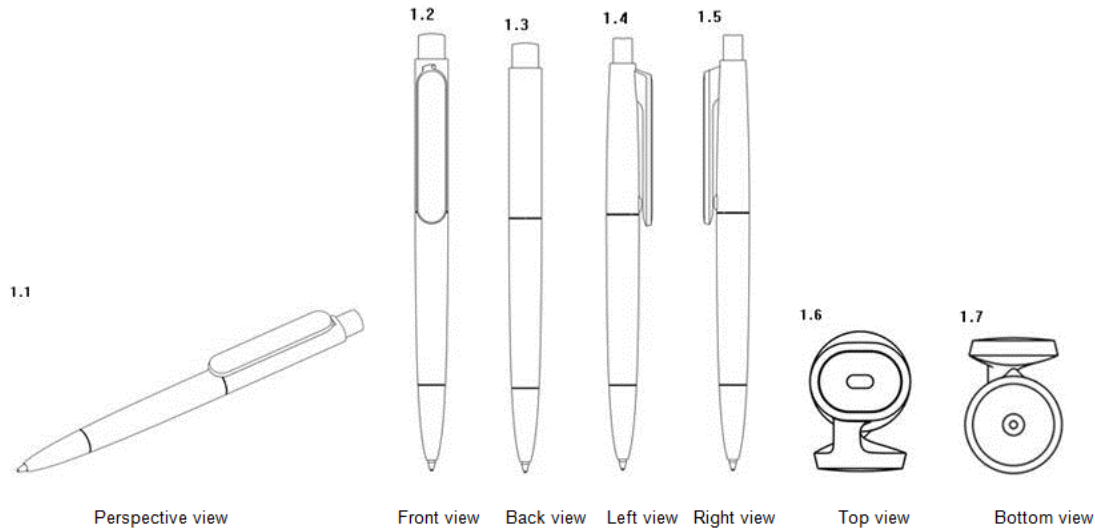
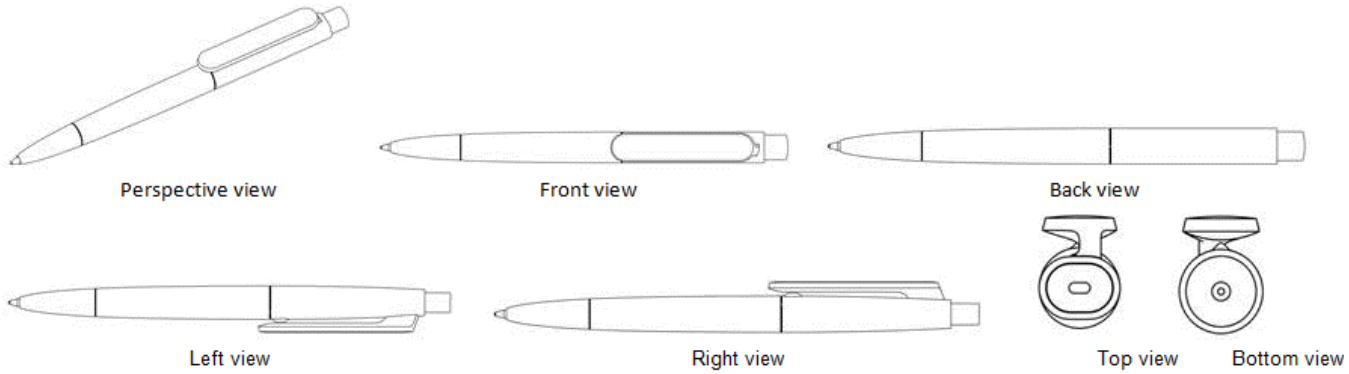

DM/084081 “Pen”

# Legends: Some example of views

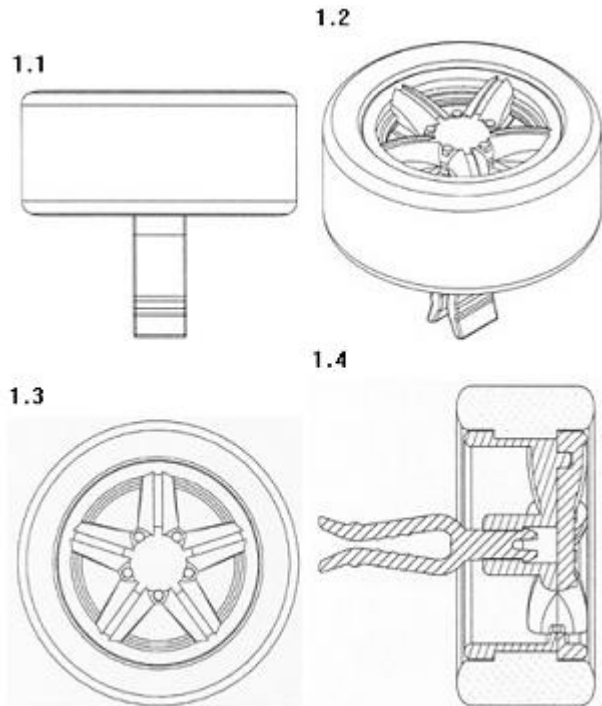

Cross section view

DM/084170 “Air deodorizing device”



Enlarged view

DM/084607 “Tire”

# Legends: Some example of views

1.6



1.11

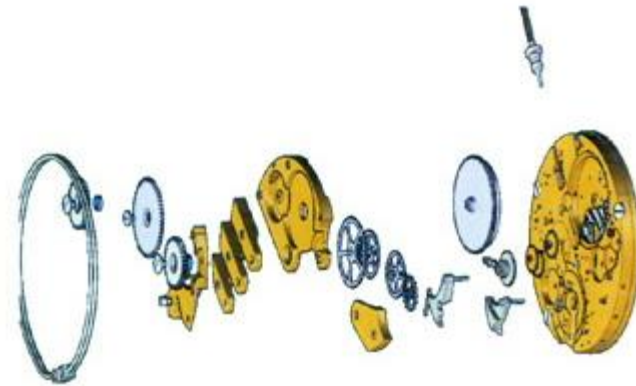

Exploded view

DM/078436 “Watch mechanism, namely minute repeater movement with constant force and disengagement lever”

# Legends: Some example of views

Unfolded view



DM/078316 “Packaging for tea ”

# Legends: Some example of views

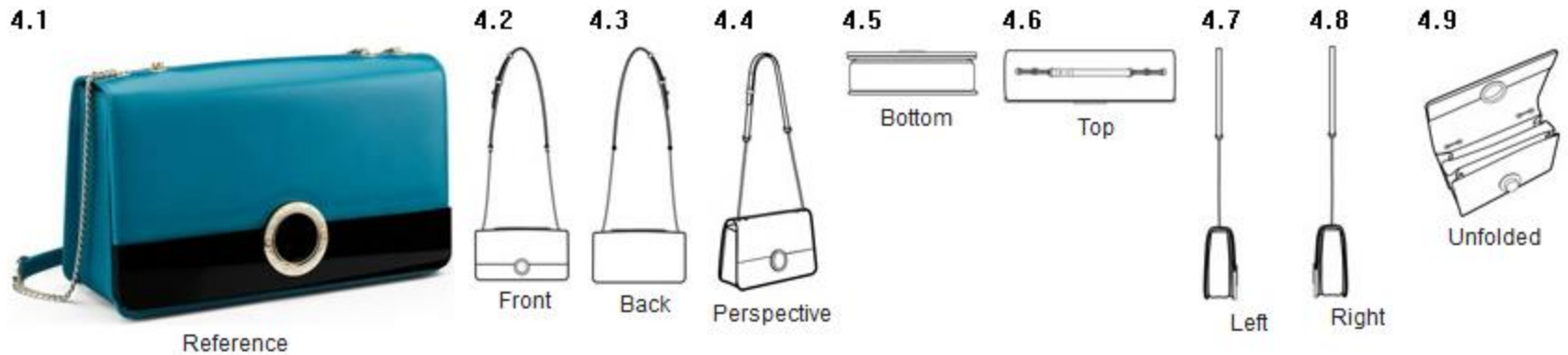

DM/085804; “Bag”

# Disclaimer

# Disclaimer (Section 403(a))

- "Disclaimer" of protection for part of the industrial design may be indicated:
  - in the description (by text), and/or
  - by means of dotted or broken lines or coloring

# Disclaimer by coloring

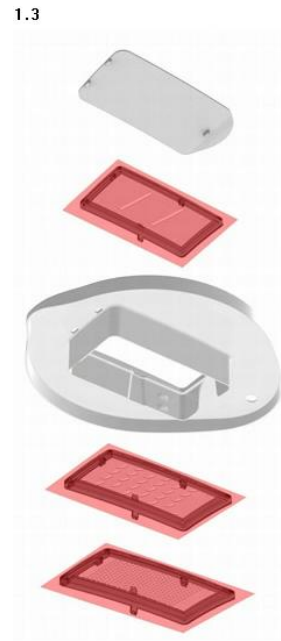

DM/080877 “Lid [household]”



# Disclaimer by coloring and description

2.1



2.2



2.3



“The blue marked parts of designs 2 to 4 are not coming into the scope of the industrial design (disclaimer)”

DM/080861 “Vehicle bodywork”

# Disclaimer by means of dotted lines and description

2.1

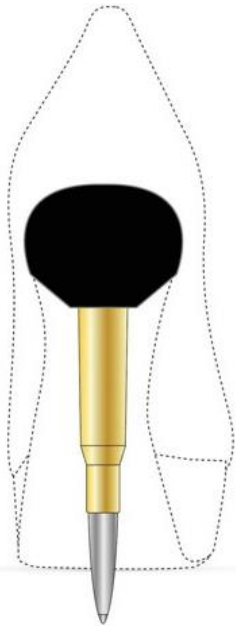

2.2



2.3

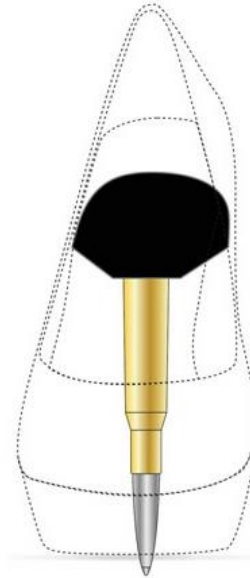

DM/082544; "Shoe"

"No protection is sought for the matter shown in dotted lines (disclaimer)"

# Not protected elements (Section 403(b))



DM/082846 “Bags”

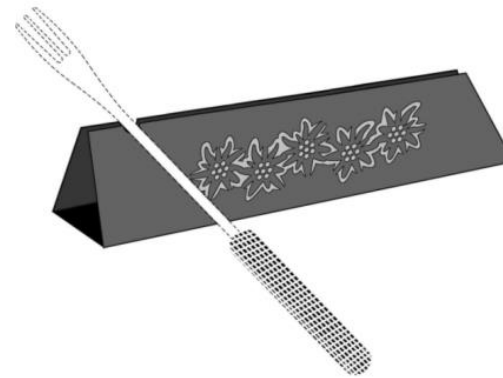

DM/080221 “Cutlery holder”

# Representation of the industrial design

- The following shall NOT be accepted:
  - Person or animal
  - Technical drawings, particularly with axes and dimensions
  - Explanatory text or legends in the representation
  
- Merging should be at least 5 millimeters
- Cut at right angles
- Shown against neutral background
- Correct numbering

# Product indication

# Product indication

## ■ Specific

■ Not writing instrument, but ball-point pen



■ Not lightening device, but table lamp



## ■ One per design

■ Not carpets, mats or rugs, but bathroom mat

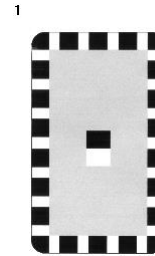

■ Not ornamentation, graphic symbols or logo, but logo



# Product indication and Locarno class

Class 32-00

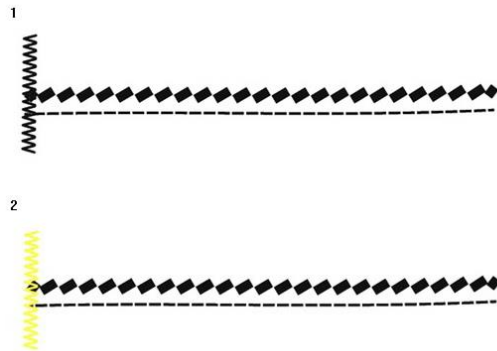

DM/079485; “Ornamentation”

Class 09-05



DM/084887; “Ornamentation for packaging bags”

# Description



# Description

## ■ Legends

## Description

Design 1: 1.1 front view; 1.2 top view;  
1.3 bottom view; 1.4 perspective view

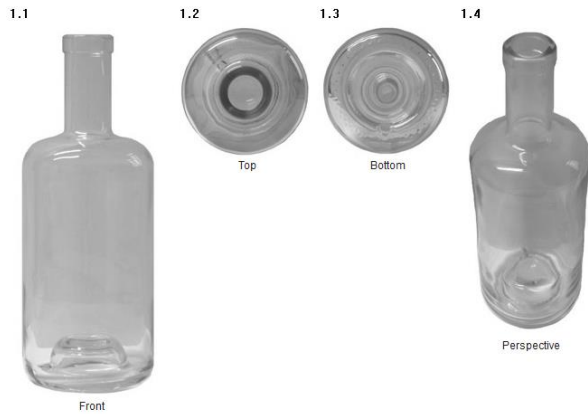

DM/085709; “Bottle”

# Description

## ■ Views omitted



DM/084264; “Watch dial”

POSSIBLE description:

“Right side, top and bottom views are omitted because they are identical or mirror image of the left side view”

# Description

## ■ Disclaimer

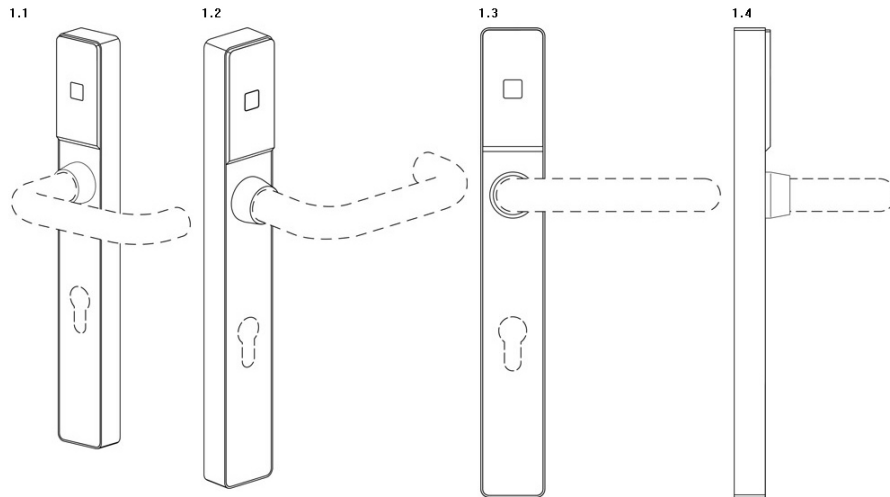

Description:

Design 1: the handle and the key hole, shown in broken lines, are not part of the claimed design;

DM/084412; “Door fittings”

# Description

- Visible features only



## Description:

Bell characterized by a vertically-oriented rectangular front panel; the panel comprises an inscription in its upper part; underneath it there is a vertically elongated recess, whose edges are straight and rounded at the top and bottom

DM/085822; "Signal bell"

# Description

- May contain possible use in order to help understand the product



DM/084820; “Heel protector”

Description:

Heel protection designed to protect the back of shoes or sandals against rubbing or damage while driving or traveling and to improve safe driving

# Locarno classification

# Locarno classification: Mono class

(class 6)

2.2



“Chair”

3.1



“Cabinet”

7.1



“Dining table”

13.1



“Sofa”

21.1



“Corner table”

DM/083137

# Locarno classification: Multiple classes

## Class 12



DM/081329

## Class 6



DM/073710

## Class 26



DM/084440



# Republic of Korea

# Related designs (Section 407)

- Indication of the principal design in the application form
  - specifying “related designs”
  - paper form: Annex A to DM/1

# Related designs

(from May 13, 2015)

**16**

RELATION WITH A PRINCIPAL DESIGN (Optional element applicable to the designation of **Japan** and/or **Republic of Korea** only)

(a) Check the appropriate box:

Contracting Party concerned:  Japan and/or  Republic of Korea

The applicant requests **all** the industrial designs which are contained in the present international application to be registered as a related design, or

The applicant requests **the following** industrial designs which are contained in the present international application to be registered as a related design(s):

(Indicate the number(s) of the industrial design(s) concerned.)

.....  
.....

DRAFT

(b) Information concerning the **principal design** (check the appropriate box, and provide the required information)

(i) The **principal design** is the subject of:

the present international application

a prior international application designating the Contracting Party concerned  
WIPO reference<sup>11</sup>: .....

a prior international registration designating the Contracting Party concerned  
International Registration No.: .....

a prior national application filed with the Office of the Contracting Party concerned  
Application No./Applicant's reference: .....

a prior national registration at the Office of the Contracting Party concerned  
National registration No.: .....

(ii) If the above national or international application or registration contains more than one industrial design, indicate the number of the industrial design to be considered as the principal design:

Design number of the principal design: .....

If the space provided is not sufficient, check this box and use a continuation sheet.

<sup>11</sup> WIPO reference is indicated in the International Bureau's acknowledgement of receipt of an international application ("WIPOxxxxx (5 digits)" or "xxxxxxx (9 digits)").

# Exception to lack of novelty

- Declaration in the application form
  - paper form: Annex B to DM/1
  - possible indication of designs concerned
  
- Supporting document
  - E-filing: uploading
  - paper form: attachment to Annex B

# Exception to lack of novelty

(from May 13, 2015)

**15**

EXCEPTION TO LACK OF NOVELTY (Optional element applicable to the designation of **Japan** and/or **Republic of Korea** only)

Contracting Party concerned:  Japan<sup>9</sup> and/or  Republic of Korea<sup>10</sup>

The applicant claims to benefit from exceptional treatment provided for in the design law of the Contracting Party(ies) concerned, for disclosure of all the industrial designs, or the industrial designs indicated below, included in the present application.

.....  
.....

.....  
.....

DRAFT

<sup>9</sup> The supporting documentation must be submitted directly to the Japan Patent Office (JPO) within 30 days after publication of the international registration.

<sup>10</sup> The supporting documentation may be submitted along with this international application using Annex II or directly to the Korean Intellectual Property Office (KIPO) in due course.

# Exception to lack of novelty

(from May 13, 2015)

DM/1/II (E)

# DRAFT

**ANNEX II:**  
**SUPPORTING DOCUMENT(S)**  
**CONCERNING A DECLARATION TO THE EXCEPTION OF LACK OF NOVELTY**  
**under Section 408(c)(ii) of the Administrative Instructions**

**IMPORTANT**

1. This cover sheet is to submit documentation accompanying an international application in support of a declaration concerning exception to lack of novelty (DM/1, item 15) in respect of a designation of the **Republic of Korea** only.
2. Supporting documentation for Japan must be submitted directly to the Japan Patent Office (JPO) in due course.
3. Please note that a declaration concerning exception to lack of novelty might affect the applicant's rights in other jurisdictions. It is the responsibility of the applicant to ensure that his rights are preserved.
4. This Annex must be submitted with the DM/1 form. It cannot be submitted alone.
5. Please number your pages.

For use by the applicant

This Annex concerns the international application referenced by the applicant as below:

Reference: .....

For use by the International Bureau

Document type: DDD

II SUPPORTING DOCUMENTS TO SUBMIT TO AN OFFICE		
Contracting Party concerned	Design(s) number(s) (leave empty if the documents concern all designs)	Number of pages
Republic of Korea		

# Specific views

- Declaration under Rule 9(3): Views required
  - Set of articles
    - one view showing the whole set
    - views showing each component
  - Typefaces:
    - view showing all the characters
    - view showing a sample sentence
    - view showing typical characters

# Hybrid national system

## Locarno Class

- Non-novelty examination

  - Class 2: clothing etc.

  - Class 5: textile etc.

  - Class 19: stationery etc.

- Novelty examination for all other classes

- Designs in the class 32 cannot obtain protection



# Duration and Fee

- Article 17(3)(c):
  - The maximum duration of protection: 20 years
  
- Rule 18(1)(b):
  - The refusal period: 12 months
  - For the classes 2, 5, 19: 6 months
  
- Article 7(2):
  - Individual designation fee: 210 CHF per design
  - For the classes 2, 5, 19: Level 3 standard designation fee

# Japan

# Exception to lack of novelty

- "Declaration" in the application form (item 15)
  - Possible indication of designs concerned
  - Supporting documents: submit directly to the JPO within 30 days from the date of publication

# Specific views

- Declaration under Rule 9(3)
  - Views required: six orthographic views (front, back, right side, left side, top and bottom views)

# Priority Claim

- Claim should be made in the application form (item 13)
- The original document supporting a priority claim: submit directly to the JPO within 3 months from the date of publication

# Duration and Fee

- Article 17(3)(c):
  - The maximum duration of protection: 20 years
- Rule 18(1)(b):
  - The refusal period: 12 months
- Article 7(2):
  - Individual designation fee: 582 CHF per design

# United States of America

# Declarations made by the United States of America

- Article 17(3)(c):

- The maximum duration of protection: 15 years

- Article 11(1)(b):

- Deferment of publication: not possible

- Rule 18(1)(b):

- The refusal period: 12 months



# Declarations made by the United States of America

- Article 13 (1):
  - Unity of design
  
- Article 5(2)(a):
  - Claim
  
- Rule 8(1)(a)(ii):
  - Identity of the creator
  - Oath or declaration

# Declaration/Oath of the creator

- Standard USPTO form in English:  
<http://www.uspto.gov/sites/default/files/forms/aia0001.pdf>
- Standard USPTO form in 11 languages:  
<http://www.uspto.gov/patent/forms/translated-forms-patent-applications-filed-or-after-september-16-2012>
- Standard WIPO form in English, French and Spanish:  
**DM/1/I**

# Declaration/Oath of the creator

DM/1/I-(E)

## ANNEX I -- DECLARATION OF INVENTORSHIP (Page 1 of 1)

For use by the applicant	For use by the International Bureau
<p>This Annex concerns the international application referenced by the applicant as below.</p> <p>Reference: .....</p>	<p>Contracting Party: US</p>
<p><b>DECLARATION OF INVENTORSHIP FOR THE DESIGNATION OF THE UNITED STATES OF AMERICA</b></p> <p>I hereby declare that I believe I am the original inventor or an original joint inventor of a claimed invention in the application.</p> <p>This declaration is directed to the attached international application (if filing declaration with application).</p> <p>This declaration is directed to international application: ..... <i>(if furnishing declaration after filing the application, the declaration must identify the international application by the application number assigned by the International Bureau or the office of indirect filing, or by applicant's reference number which was on the application as filed.)</i></p> <p>I hereby declare that the above-identified international application was made or authorized to be made by me.</p> <p>I hereby acknowledge that any willful false statement made in this declaration is punishable under 18 U.S.C. 1001 by fine or imprisonment of not more than five (5) years, or both.</p> <p>Name of Inventor: .....</p> <p>Inventor's Signature: ..... Date (optional): .....</p> <p><i>(The signature must be that of the inventor, not that of the agent.)</i></p> <p>Residence: <i>(required only if the inventor lives at a location different from the mailing address contained in the international application)</i> .....</p> <p><i>(city and either U.S. state, if applicable, or country)</i></p>	

DRAFT

# Substitute statement

- Standard USPTO form in English:  
<http://www.uspto.gov/sites/default/files/forms/aia0002.pdf>
- Standard USPTO form in 11 languages:  
<http://www.uspto.gov/patent/forms/translated-forms-patent-applications-filed-or-after-september-16-2012>
- Standard WIPO form in English, French and Spanish:  
**DM/1/I**

# Declaration/Oath of the creator

## ANNEX I—SUBSTITUTE STATEMENT (Page 1 of 2)

<p style="text-align: center;"><u>For use by the applicant</u></p> <p>This Annex concerns the international application referenced by the applicant as below:</p> <p>Reference: .....</p>	<p style="text-align: center;"><u>For use by the International Bureau</u></p> <p>Contracting Party: US</p>
---	--

DRAFT

**1** **SUBSTITUTE STATEMENT IN LIEU OF A DECLARATION OF INVENTORSHIP FOR THE DESIGNATION OF THE UNITED STATES OF AMERICA**

This statement is directed to:

→ The attached international application

OR

→ international application: .....

*(If furnishing statement after filing the application, the statement must identify the international application by the application number assigned by the International Bureau or the office of indirect filing, or by applicant's reference number which was on the application as filed.)*

**NAME of inventor to whom this substitute statement applies:** .....

**Residence:** *(not required if the inventor lives at the same location as the mailing address contained in the international application, or the inventor is deceased or legally incapacitated)*

City: ..... → U.S. State: ..... → Country: .....  
*(if applicable)*

I believe the above-named inventor or joint inventor to be the original inventor or an original joint inventor of a claimed invention in the application.

The above-identified application was made or authorized to be made by me.

I hereby acknowledge that any willful false statement made in this statement is punishable under 18 U.S.C. § 1001 by fine or imprisonment of not more than five (5) years, or both.

**Relationship to the inventor to whom this substitute statement applies:**

→ Legal Representative (for deceased or legally incapacitated inventor only)

→ Assignee

→ Person to whom the inventor is under an obligation to assign



→ Person who otherwise shows a sufficient proprietary interest in the matter (a petition under 37 CFR § 1.46 is required and should be submitted directly to the USPTO after publication of the international registration), or

→ Joint inventor

# NO identity of creator and/or declaration/oath

- No creator and/or oath → irregularity notice
- 3 months to regularize
  - Registration date is NOT affected
- Not regularized → US designation is disregarded

# Claim

- US designation ONLY
- No claim  irregularity notice
- 3 months to regularize
  - Registration date is affected
- Not regularized  US designation is disregarded

# Claim

<b>12</b> CLAIM (Applicable to the designation of the <b>United States of America</b> only) <sup>8</sup> Indicate an "article of manufacture" in the blank space provided. If this is left blank, the International Bureau will insert the product indicated in relation to the first design in item 8 as the "article of manufacture".	
Claim	No. of the design(s) (All by default)
The ornamental design for ..... as shown and described	<b>DRAFT</b>
<input type="checkbox"/> If the space provided is not sufficient, check this box and use a continuation sheet.	
<sup>8</sup> If the <b>United States of America</b> is designated in item 7, this information is mandatory.	



# Eligibility for protection

DM/1/III (E)

# DRAFT

## ANNEX III:

### INFORMATION ON ELIGIBILITY FOR PROTECTION

under Rule 7(5)(g) and Section 408(d) of the Administrative Instructions

#### IMPORTANT

1. This cover sheet is optional and serves to submit a statement under Rule 7(5)(g) that identifies information known by the applicant to be material to the eligibility for protection of the industrial design concerned.
2. This cover sheet is only relevant for the designation of the **United States of America** and serves to submit an *Information Disclosure Statement* and relevant accompanying documentation as prescribed under the United States national laws.
3. The *Information Disclosure Statement* forms (SB08a/SB08b/SB08a-EFS-web) are available on the United States Patent and Trademark Office (USPTO) web site: [http://www.uspto.gov/forms/aia\\_forms.jsp](http://www.uspto.gov/forms/aia_forms.jsp).
4. For detailed information on the *Information Disclosure Statement*, please visit the USPTO web site: <http://www.uspto.gov/web/offices/pac/mpep/s609.html>.
5. This cover sheet must be submitted with the DM/1 form. It cannot be submitted alone.
6. Please number your pages.

#### For use by the applicant

This Annex concerns the international application referenced by the applicant as below:

Reference: .....

#### For use by the International Bureau

Document type:

III

INFORMATION ON ELIGIBILITY FOR PROTECTION

Number of pages: .....

# Individual designation fee

18

REDUCTION OF UNITED STATES INDIVIDUAL DESIGNATION FEE (Applicable for the designation of the **United States of America** only)

DRAFT

Check the appropriate box:

- The applicant asserts **small entity** status within the meaning of Section 41(h) of Title 35 of the United States Code and Section 3 of the Small Business Act, and applicable regulations of the U.S. Patent and Trademark Office.
- The applicant certifies **micro entity** status within the meaning of Section 123 of Title 35 of the United States Code and applicable regulations of the U.S. Patent and Trademark Office. The applicant must **submit the micro entity certification** form PTO/SB/15A or PTO/SB/15B using Annex IV.

# Individual designation fee: WIPO form

<b>DM/1/IV (E)</b>					
<h1>DRAFT</h1>					
<b>ANNEX IV: REDUCTION OF UNITED STATES INDIVIDUAL DESIGNATION FEE under Section 408(b) of the Administrative Instructions</b>					
<b><u>IMPORTANT</u></b>					
<ol style="list-style-type: none"><li>1. This cover sheet is only relevant for the designation of the <b>United States of America</b> and is mandatory content if the applicant claims <b>micro entity status</b> in the DM/1 form. It cannot be submitted alone.</li><li>2. This document is to submit a <b>certification</b> following Section 408(b) of the Administrative Instructions.</li><li>3. The certification form (PTO/SB/15A or PTO/SB/15B), along with the instructions for its completion and signature, is available on the United States Patent and Trademark Office web site: <a href="http://www.uspto.gov/forms/aia_forms.jsp">http://www.uspto.gov/forms/aia_forms.jsp</a>.</li><li>4. Please number your pages.</li></ol>					
<p style="text-align: center;"><u>For use by the applicant</u></p> <p>This Annex concerns the international application referenced by the applicant as below:</p> <p>Reference: .....</p>	<p style="text-align: center;"><u>For use by the International Bureau</u></p> <p>Document type: Contracting Party: US</p>				
<table border="1"><tr><td style="background-color: black; color: white; padding: 2px;"><b>IV</b></td><td style="padding: 2px;"><b>REDUCTION OF INDIVIDUAL DESIGNATION FEES</b></td></tr><tr><td colspan="2" style="text-align: center; padding: 5px;">Number of pages: .....</td></tr></table>		<b>IV</b>	<b>REDUCTION OF INDIVIDUAL DESIGNATION FEES</b>	Number of pages: .....	
<b>IV</b>	<b>REDUCTION OF INDIVIDUAL DESIGNATION FEES</b>				
Number of pages: .....					

# Individual designation fee: USPTO form

CERTIFICATION OF MICRO ENTITY STATUS (GROSS INCOME BASIS)	
Application Number or Control Number (if applicable):	Patent Number (if applicable):
First Named Inventor:	Title of Invention:
<p>The applicant hereby certifies the following—</p> <p>(1) <b>SMALL ENTITY REQUIREMENT</b> – The applicant qualifies as a small entity as defined in 37 CFR 1.27.</p> <p>(2) <b>APPLICATION FILING LIMIT</b> – Neither the applicant nor the inventor nor a joint inventor has been named as the inventor or a joint inventor on more than four previously filed U.S. patent applications, excluding provisional applications and international applications under the Patent Cooperation Treaty (PCT) for which the basic national fee under 37 CFR 1.492(a) was not paid, and also excluding patent applications for which the applicant has assigned all ownership rights, or is obligated to assign all ownership rights, as a result of the applicant's previous employment.</p> <p>(3) <b>GROSS INCOME LIMIT ON APPLICANTS AND INVENTORS</b> – Neither the applicant nor the inventor nor a joint inventor, in the calendar year preceding the calendar year in which the applicable fee is being paid, had a gross income, as defined in section 61(a) of the Internal Revenue Code of 1986 (26 U.S.C. 61(a)), exceeding the "Maximum Qualifying Gross Income" reported on the USPTO Web site at <a href="http://www.uspto.gov/patents/law/micro_entity.jsp">http://www.uspto.gov/patents/law/micro_entity.jsp</a> which is equal to three times the median household income for that preceding calendar year, as most recently reported by the Bureau of the Census.</p> <p>(4) <b>GROSS INCOME LIMIT ON PARTIES WITH AN "OWNERSHIP INTEREST"</b> – Neither the applicant nor the inventor nor a joint inventor has assigned, granted, or conveyed, nor is under an obligation by contract or law to assign, grant, or convey, a license or other ownership interest in the application concerned to an entity that, in the calendar year preceding the calendar year in which the applicable fee is being paid, had a gross income, as defined in section 61(a) of the Internal Revenue Code of 1986, exceeding the "Maximum Qualifying Gross Income" reported on the USPTO Web site at <a href="http://www.uspto.gov/patents/law/micro_entity.jsp">http://www.uspto.gov/patents/law/micro_entity.jsp</a> which is equal to three times the median household income for that preceding calendar year, as most recently reported by the Bureau of the Census.</p>	
SIGNATURE by an <a href="#">authorized party</a> set forth in 37 CFR 1.33(b)	
Signature	
Name	
Date	Telephone
	Registration No.
<input type="checkbox"/>	There is more than one inventor and I am one of the inventors who are jointly identified as the applicant. The required additional certification form(s) signed by the other joint inventor(s) are included with this form.

CERTIFICATION OF MICRO ENTITY STATUS (INSTITUTION OF HIGHER EDUCATION BASIS)	
Application Number or Control Number (if applicable):	Patent Number (if applicable):
First Named Inventor:	Title of Invention:
<p><b>CERTIFICATION ON THE BASIS OF EMPLOYMENT BY AN INSTITUTION OF HIGHER EDUCATION</b></p> <p>The applicant hereby certifies the following—</p> <p>The applicant qualifies as a small entity as defined in 37 CFR 1.27.</p> <p>The applicant's employer, from which the applicant obtains the majority of the applicant's income, is an institution of higher education as defined in section 101(a) of the Higher Education Act of 1965 (20 U.S.C. 1001(a)).</p>	
SIGNATURE by an <a href="#">authorized party</a> set forth in 37 CFR 1.33(b)	
Signature	
Name	
Date	Telephone
	Registration No.
<input type="checkbox"/>	There is more than one inventor and I am one of the inventors who are jointly identified as the applicant. The required additional certification form(s) signed by the other joint inventor(s) are included with this form.
<p><b>CERTIFICATION ON THE BASIS OF ASSIGNMENT OR OBLIGATION TO ASSIGN TO AN INSTITUTION OF HIGHER EDUCATION</b></p> <p>The applicant hereby certifies the following—</p> <p>The applicant qualifies as a small entity as defined in 37 CFR 1.27.</p> <p>The applicant has assigned, granted, conveyed, or is under an obligation by contract or law, to assign, grant, or convey, a license or other ownership interest in the particular application to an institution of higher education as defined in section 101(a) of the Higher Education Act of 1965 (20 U.S.C. 1001(a)).</p>	
SIGNATURE by an <a href="#">authorized party</a> set forth in 37 CFR 1.33(b)	
Signature	
Name	
Date	Telephone
	Registration No.
<input type="checkbox"/>	There is more than one inventor and I am one of the inventors who are jointly identified as the applicant. The required additional certification form(s) signed by the other joint inventor(s) are included with this form.

